

NELUX ARCHITECTURAL LIGHTING PRODUCTS

BOOK 2023-2024

FLEXIBLE MAGNETIC LIGHTING SYSTEM

**VX MODEL**

**V48DC**





Smart Lighting  
Luminous Environment

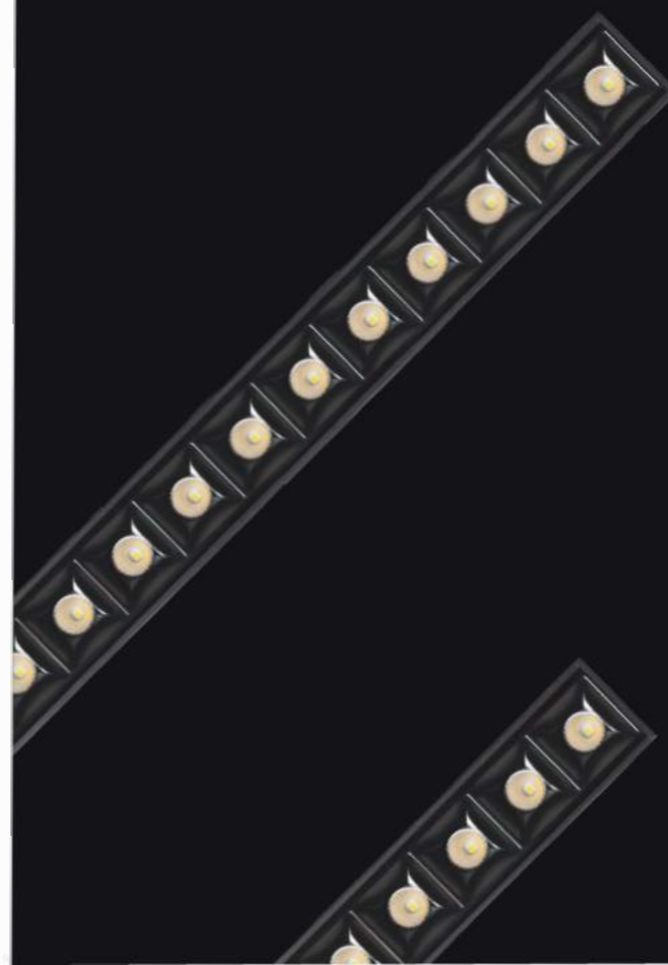

# Index

## Spotlight series

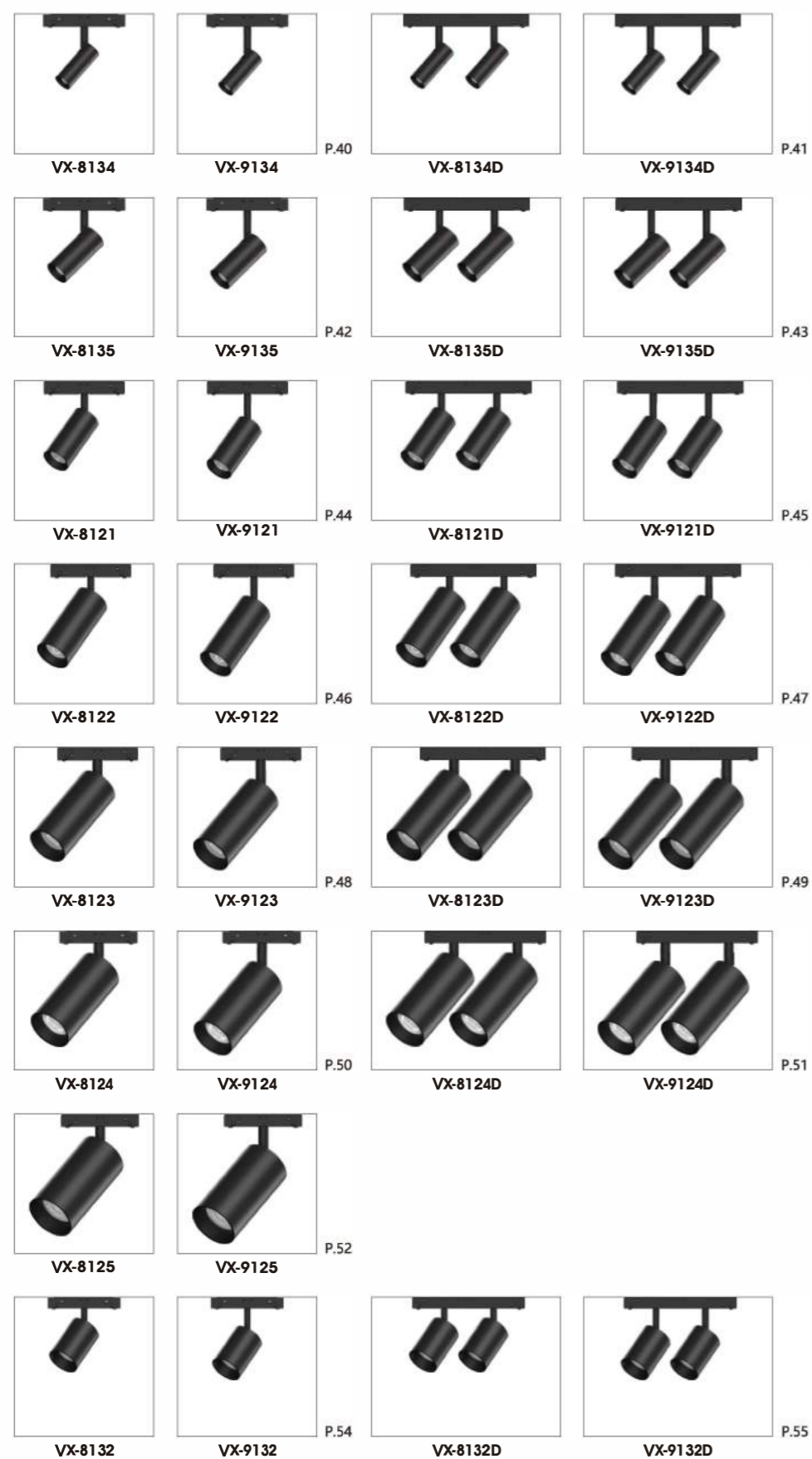

## Spotlight series

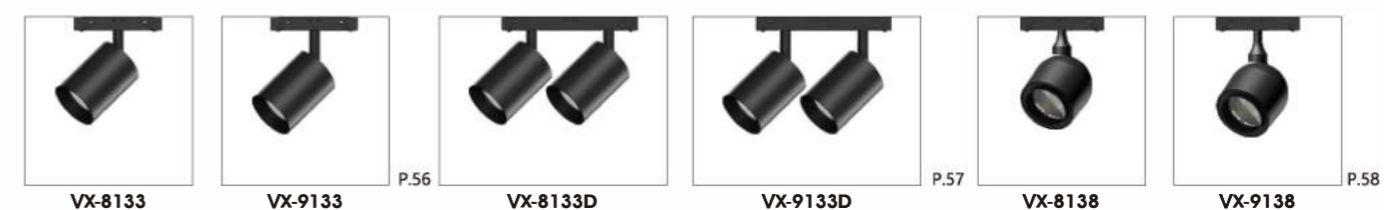

## Square spotlight series



## Dimmer Spotlight series

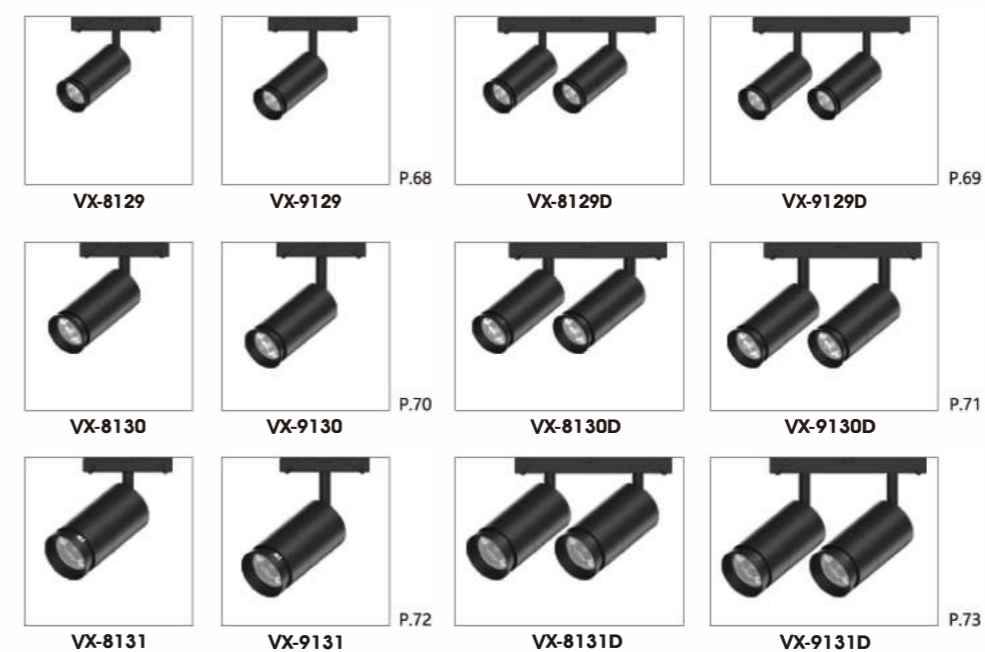

# Index

## Adjustable Linear series

---

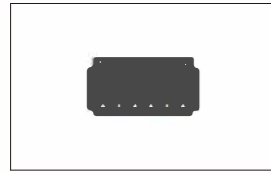

VX-8223

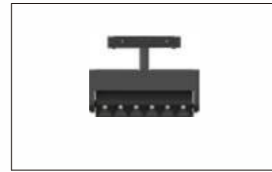

VX-9223



VX-8224

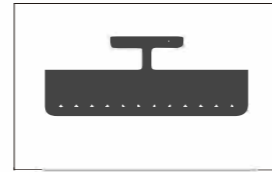

VX-9224

P.75-76



VX-9239

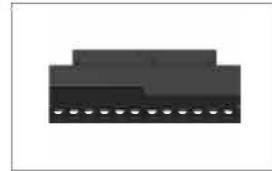

VX-9241

P.78

## Adjustable Floodlight series

---



VX-9240



VX-9242

P.80

## Linear Linear series

---



VX-9234



VX-9228



VX-9232



VX-9229

P.84-85

## Floodlight series

---



VX-9235

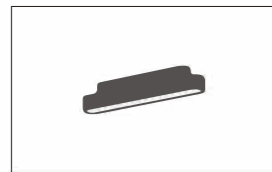

VX-9230

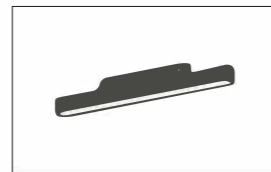

VX-9233

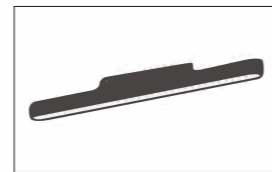

VX-9231

P.86-87



VX-9236



VX-9237



VX-9238

P.88-89

## Pendant series

---

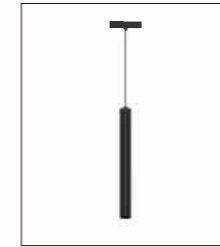

VX-9321



VX-9322



VX-9323



VX-9324



VX-9325

P.91-93

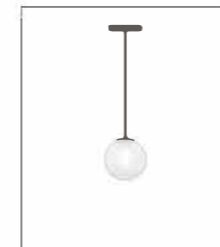

VX-9326



VX-9327

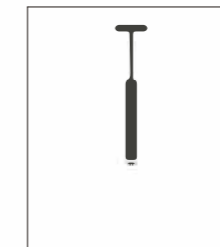

VX-9328

P.93-94

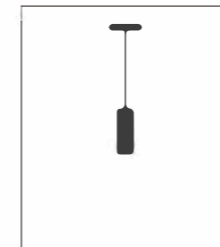

VX-9329

P.95

## Wall washer

---

Coming soon...

磁吸轨道照明可选择不同智能控制系统

Magnetic track lighting offers different options for intelligent control system.

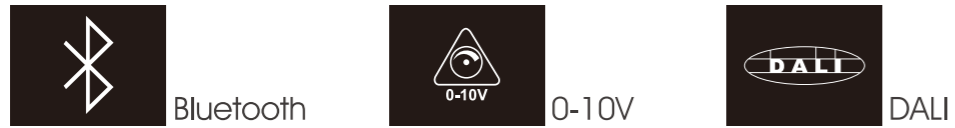

磁吸轨道不同组合应用

The same product in many different ways.

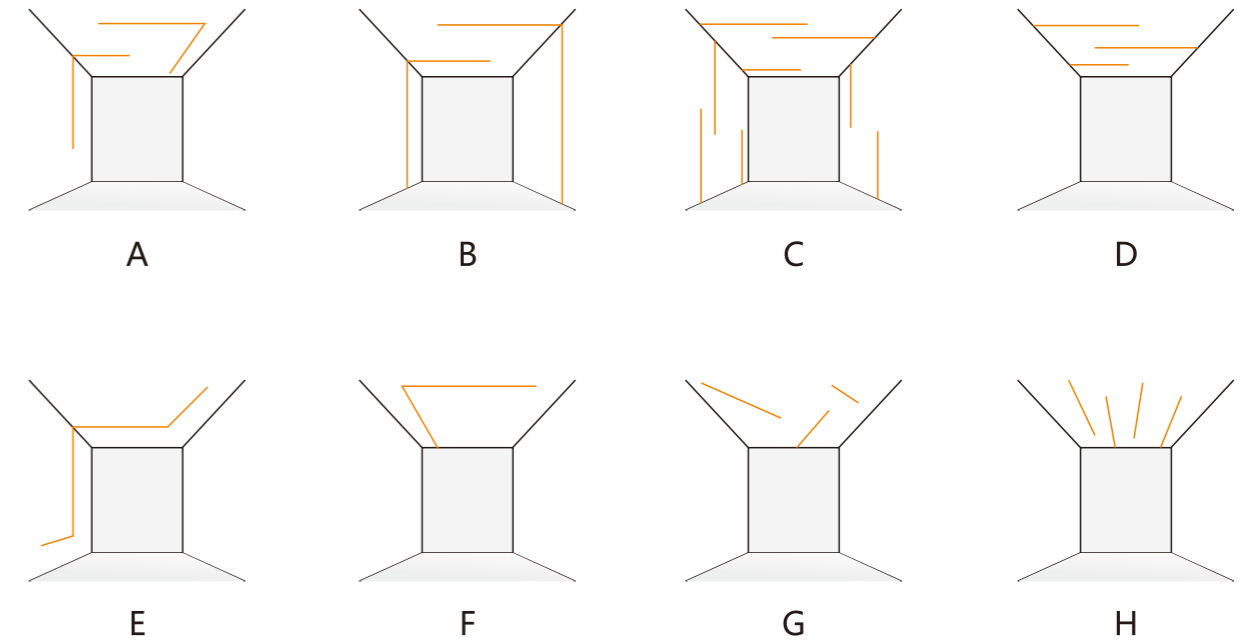

灵活应用的磁吸轨道照明系统能实现多种灯光设计要求。

Perfect lighting can handle any transformation.

Flexible application tracks and luminaires fit your personalized needs.

...

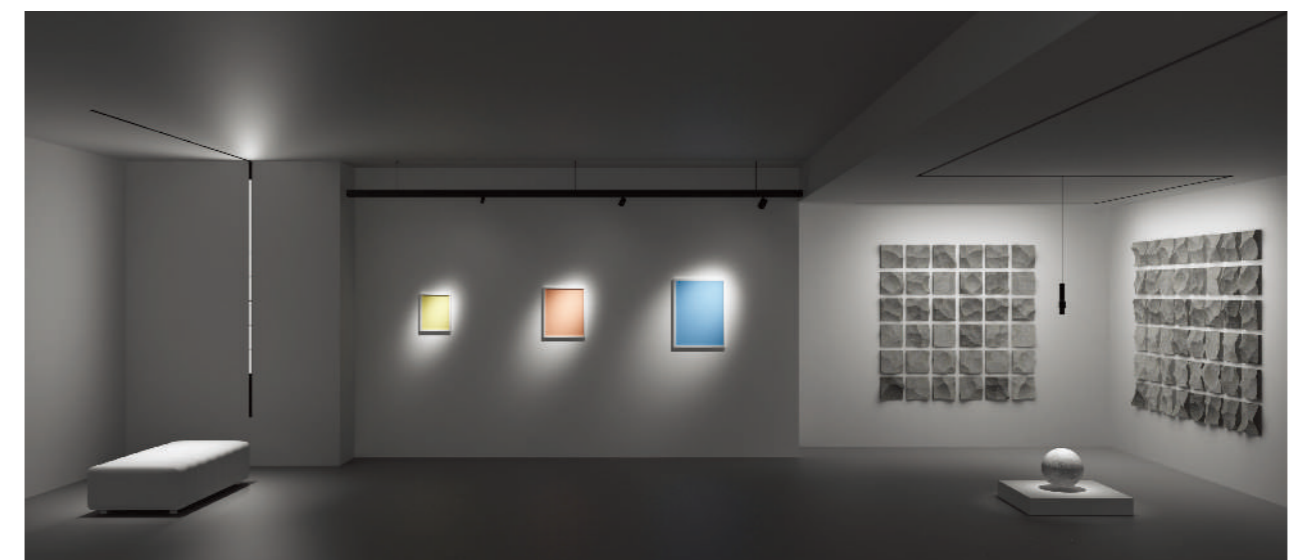

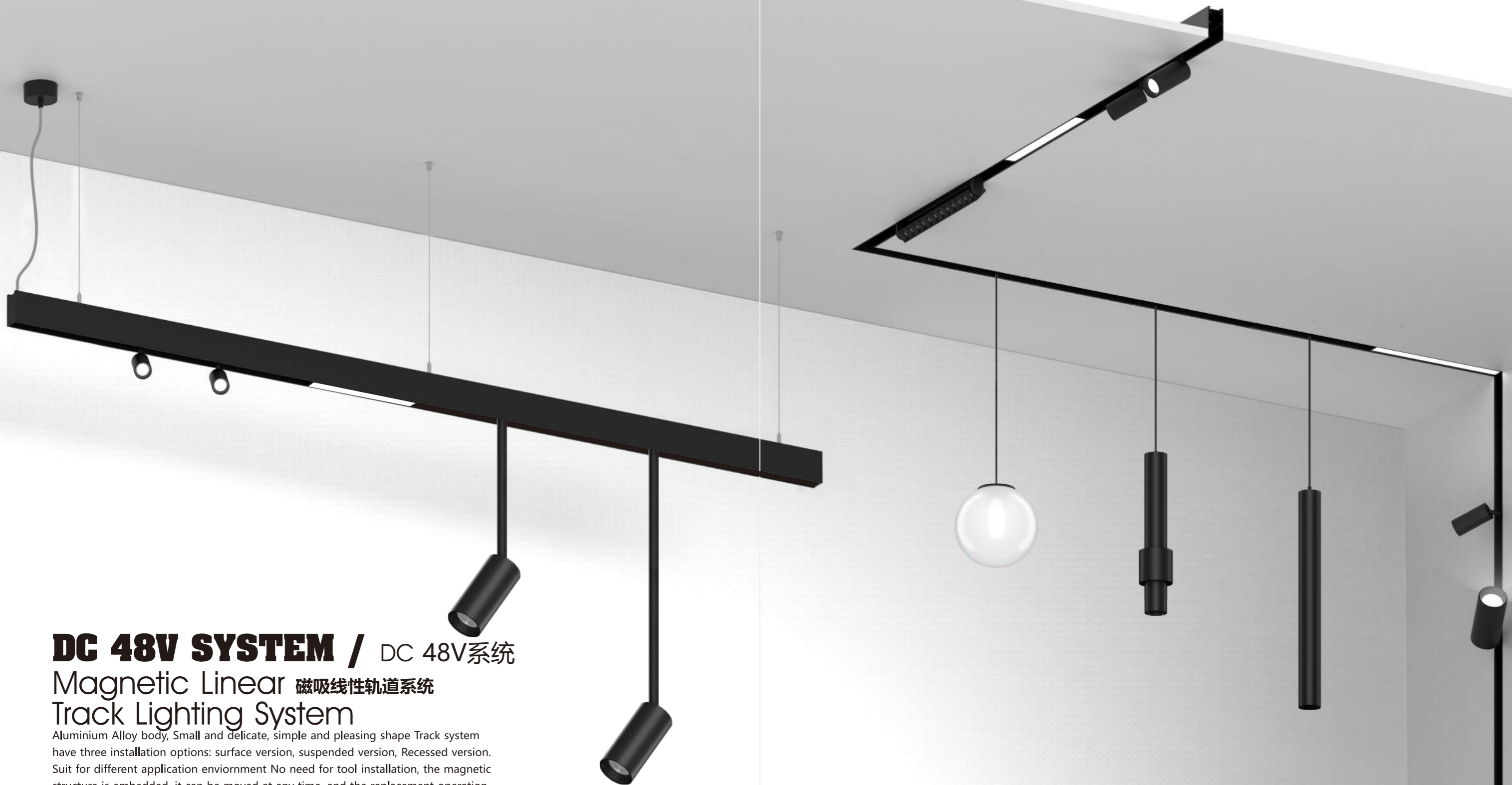

## **DC 48V SYSTEM /** DC 48V系统 Magnetic Linear 磁吸线性轨道系统 Track Lighting System

Aluminium Alloy body, Small and delicate, simple and pleasing shape Track system have three installation options: surface version, suspended version, Recessed version. Suit for different application environment No need for tool installation, the magnetic structure is embedded, it can be moved at any time, and the replacement operation is simple and convenient. The luminaire module has various combinations of floodlighting, wall washing and spotlighting to meet the point, line and surface lighting requirements of the space structure. The system is powered by DC 48V, which is safe, efficient and energy-saving. It can be widely used in commercial shops. DALI/0-10V/Triac dimming options available upon request

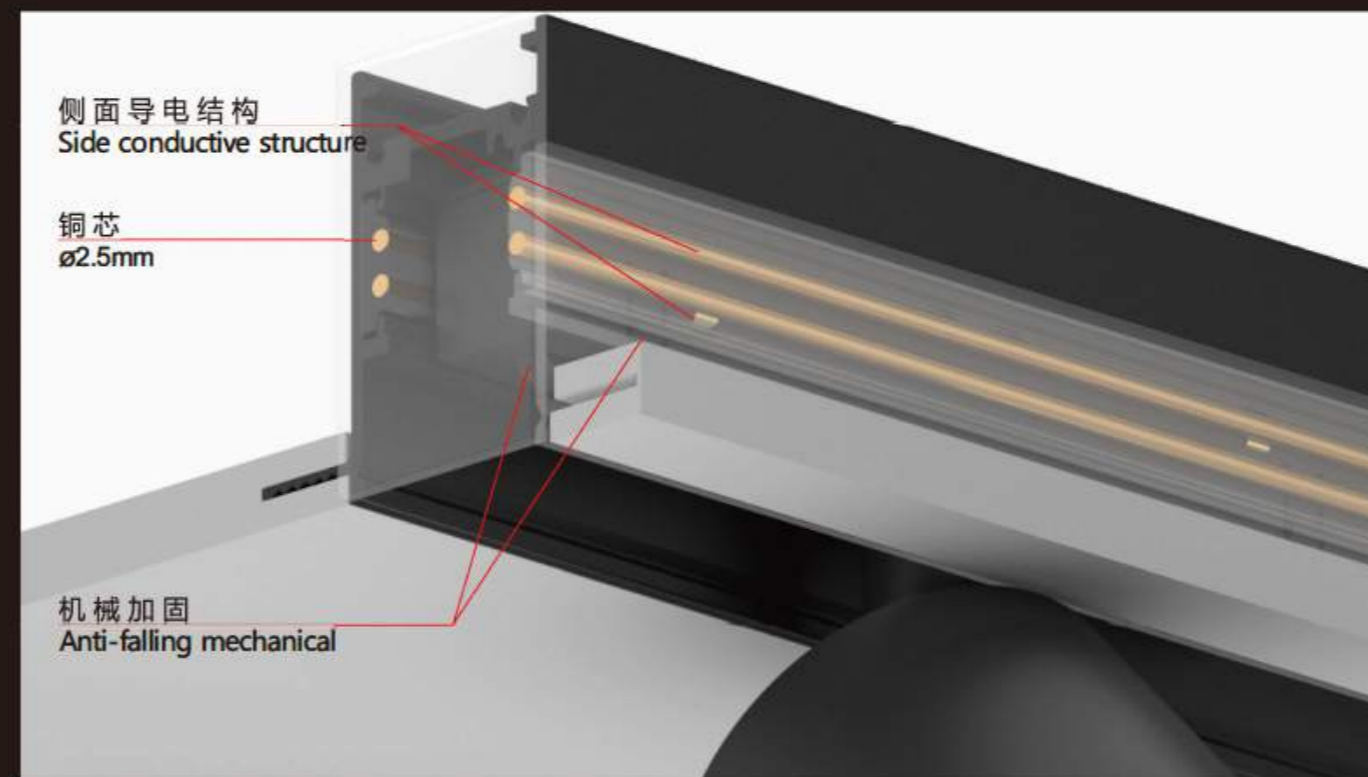
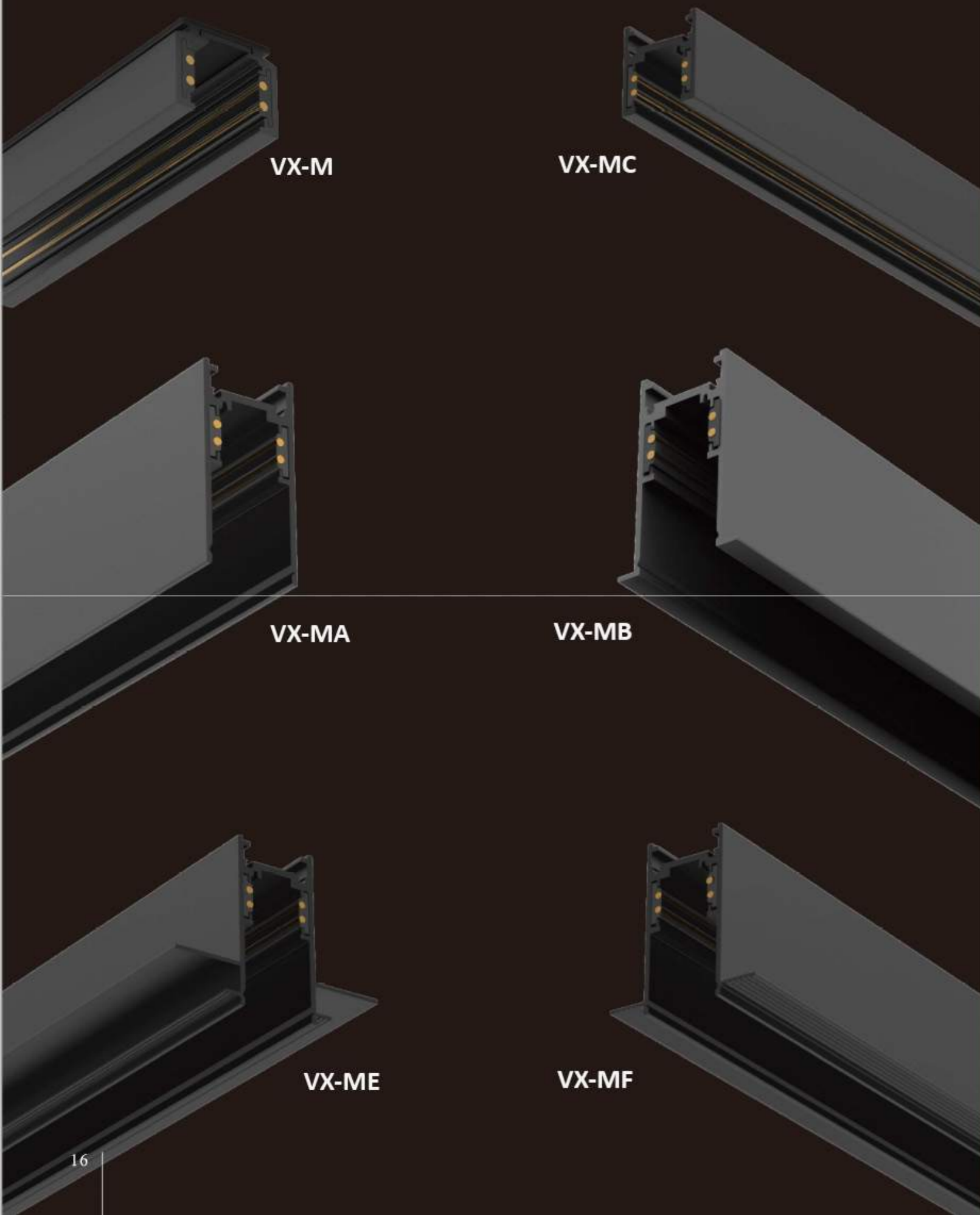

VX-M



VX-MA

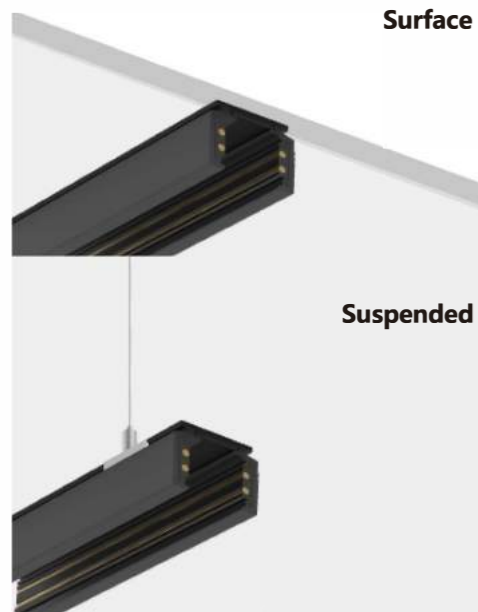
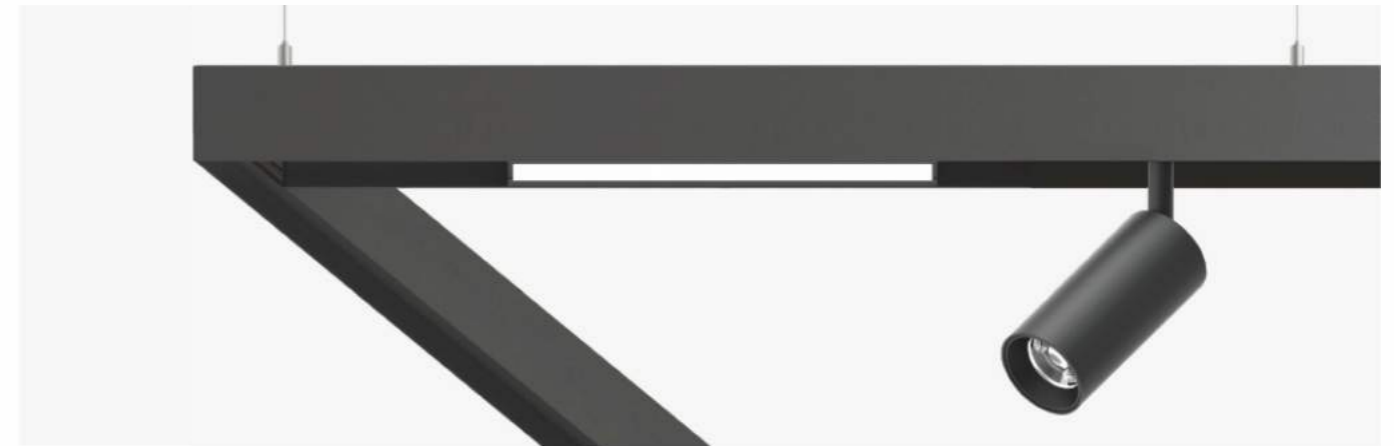

Surface

Suspended

Length specification : 1000/1500/2000mm

Model NO.	Length	Colour
VX-M10	1000mm	□ White
VX-M15	1500mm	■ Black
VX-M20	2000mm	■ Black

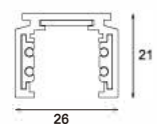

Accessories for VX-M

Model Code VX-M031B end feed	Model Code VX-M032 joint connector	Model Code VX-M033 L connector	
Model Code VX-M035B Adjustable Connector	Model Code VX-M022 joint Part	Model Code VX-M025 end cap (hole for cable)	Model Code VX-M026 end cap (hole for cable)

Suspension Kit

Model Code CX-M020	Standard length 1000mm, can be customized length.	

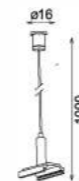

Surface

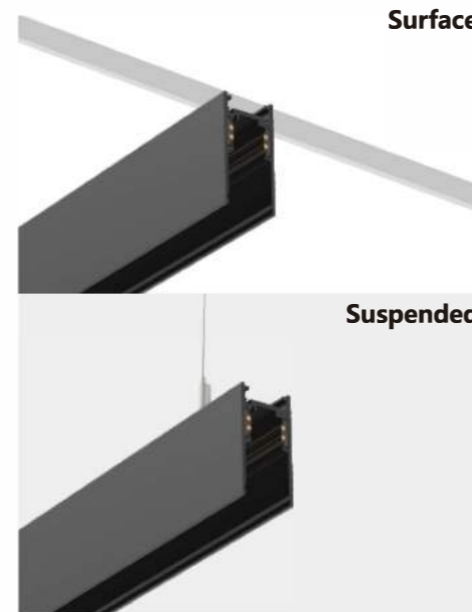

Suspended

Length specification : 1000/1500/2000mm

Model NO.	Length	Colour
VX-MA10	1000mm	□ White
VX-MA15	1500mm	■ Black
VX-MA20	2000mm	■ Black

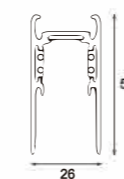

Accessories for VX-MA

Model Code VX-MAP01 L Connector	Model Code VX-MAP02 L Connector	Model Code VX-MAP03 L Connector	Model Code VX-MAP04 T Connector	Model Code VX-MAP05 X Connector
Model Code VX-MAP06 Connector	Model Code VX-M023 joint Part	Model Code VX-M029 end cap (hole for cable)	Model Code VX-M030 end cap (hole for cable)	Model Code VX-M041 Dust cover

Model Code VX-M031B end feed	Model Code VX-M032 joint connector	Model Code VX-M035B Adjustable Connector	Model Code VX-M038 T Connector	Model Code VX-M039 X Connector

Suspension Kit

Model Code VX-M021	Standard length 1000mm, can be customized length.	





VX-MC

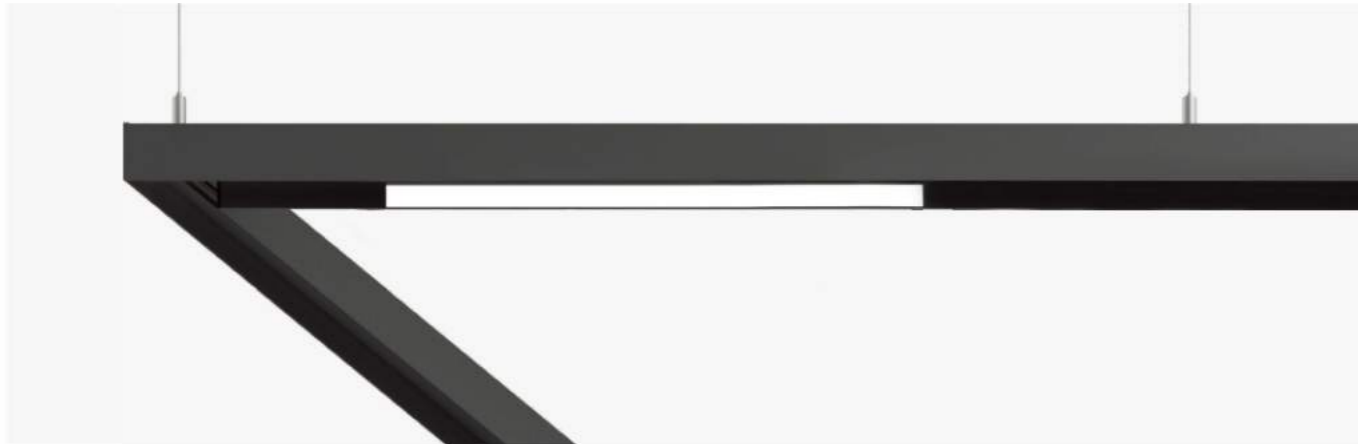

VX-MB

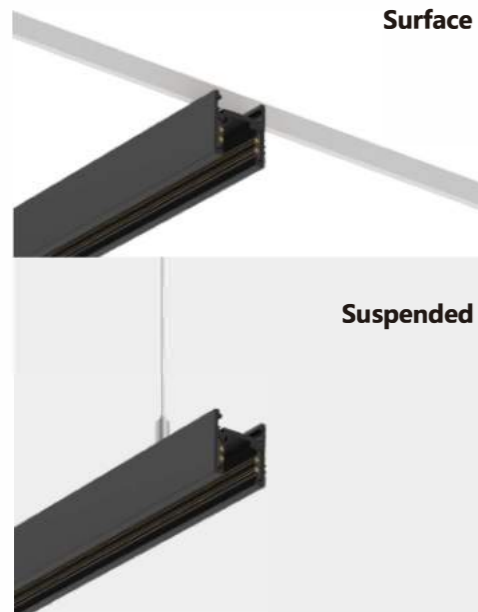

Surface

Suspended

Length specification : 1000/1500/2000mm

Model NO.	Length	Colour
VX-MC10	1000mm	White
VX-MC15	1500mm	Black
VX-MC20	2000mm	Black

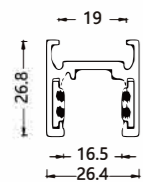

Accessories for VX-MC



Model Code	VX-M031B	VX-M032	VX-M033
	end feed	joint connector	L Connector



Model Code	VX-M035B	VX-M023	VX-M027	VX-M028
	Adjustable Connector	joint Part	end cap (hole for cable)	

Suspension Kit

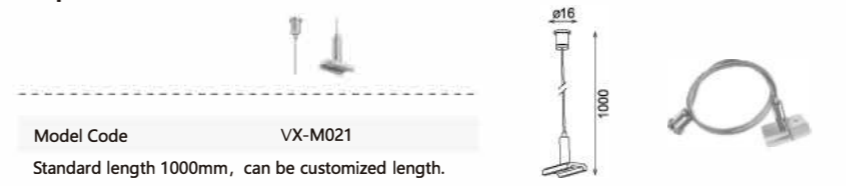

Model Code	VX-M021
	Standard length 1000mm, can be customized length.

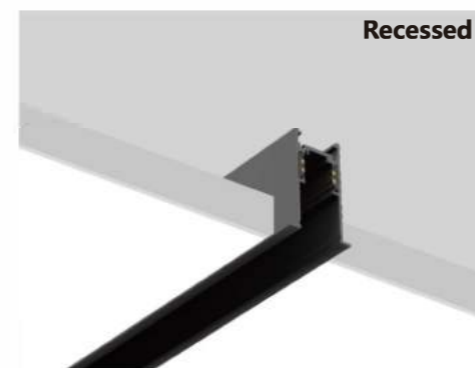

Recessed

Length specification : 1000/1500/2000mm

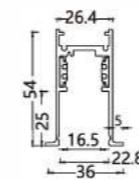

Model NO.	Length	Colour
VX-MB10	1000mm	White
VX-MB15	1500mm	Black
VX-MB20	2000mm	Black

Accessories for VX-MB

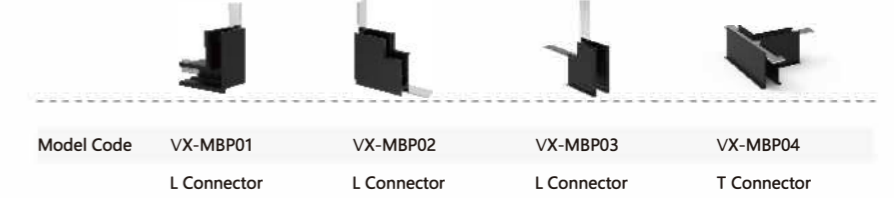

Model Code	VX-MBP01	VX-MBP02	VX-MBP03	VX-MBP04
	L Connector	L Connector	L Connector	T Connector



Model Code	VX-MBP05	VX-MBP06	VX-M029	VX-M030
	X Connector	T Connector	end cap (hole for cable)	



Model Code	VX-M031B	VX-M032	VX-M035B	VX-M023
	end feed	joint connector	Adjustable Connector	joint Part



Model Code	VX-M038	VX-M039	VX-M041
	T Connector	X Connector	Dust cover

VX-ME

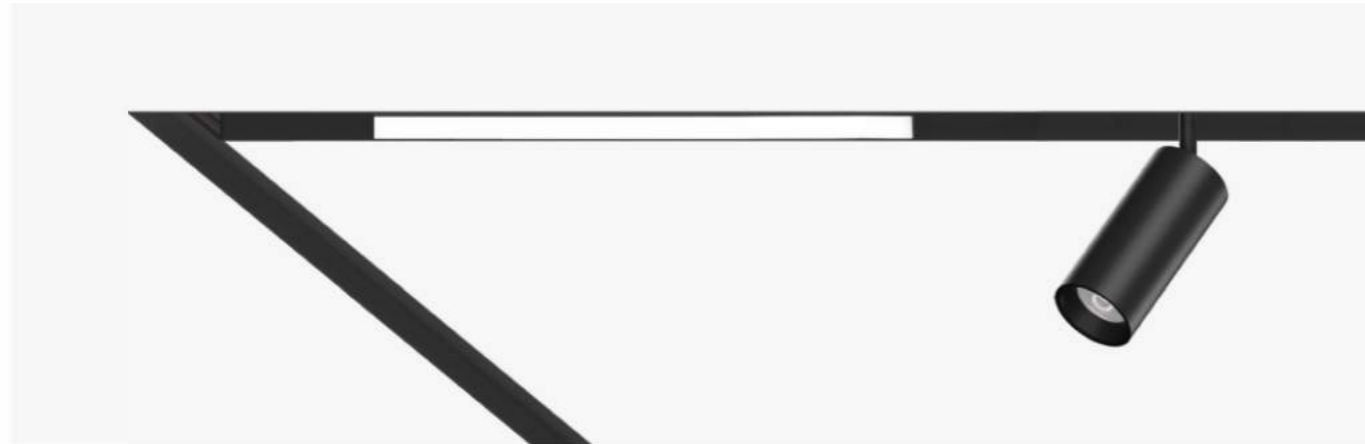

VX-MF

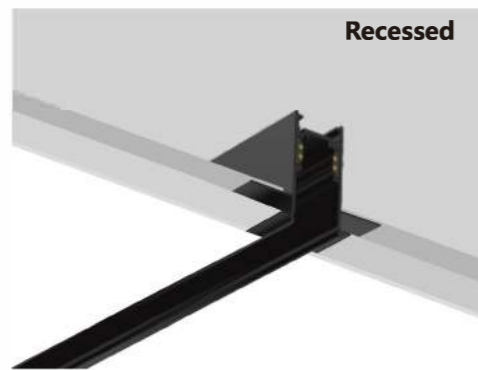

Recessed

Length specification : 1000/1500/2000mm

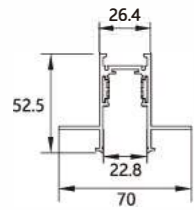

Model NO.	Length	Colour
VX-ME10	1000mm	□ White
VX-ME15	1500mm	■ Black
VX-ME20	2000mm	■ Black

Accessories for VX-ME



Model Code	VX-MEP01	VX-MEP02	VX-MEP03	VX-MEP04
	L Connector	L Connector	L Connector	T Connector



Model Code	VX-MEP05	VX-MEP06	VX-M029	VX-M030
	X Connector	Connector	end cap (hole for cable)	



Model Code	VX-M031B	VX-M032	VX-M035B	VX-M023
	end feed	joint connector	Adjustable Connector	joint Part



Model Code	VX-M038	VX-M039	VX-M041
	T Connector	X Connector	Dust cover

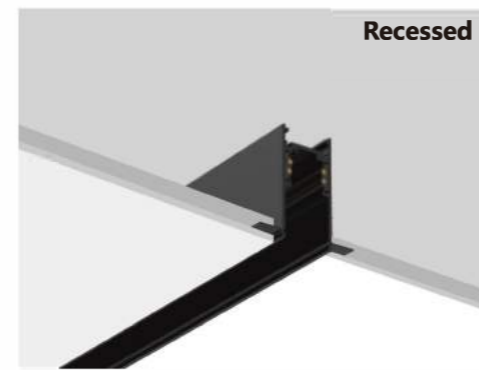

Recessed

Length specification : 1000/1500/2000mm

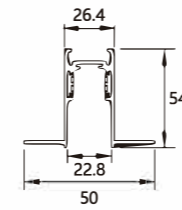

Model NO.	Length	Colour
VX-MF10	1000mm	□ White
VX-MF15	1500mm	■ Black
VX-MF20	2000mm	■ Black

Accessories for VX-MF



Model Code	VX-MFP01	VX-MFP02	VX-MFP03	VX-MFP04
	L Connector	L Connector	T Connector	X Connector



Model Code	VX-MFP05	VX-MFP06	VX-M029	VX-M030
	L Connector	L Connector	end cap (hole for cable)	



Model Code	VX-M031B	VX-M032	VX-M035B	VX-M023
	end feed	joint connector	Adjustable Connector	joint Part



Model Code	VX-M038	VX-M039	VX-M041
	T Connector	X Connector	Dust cover

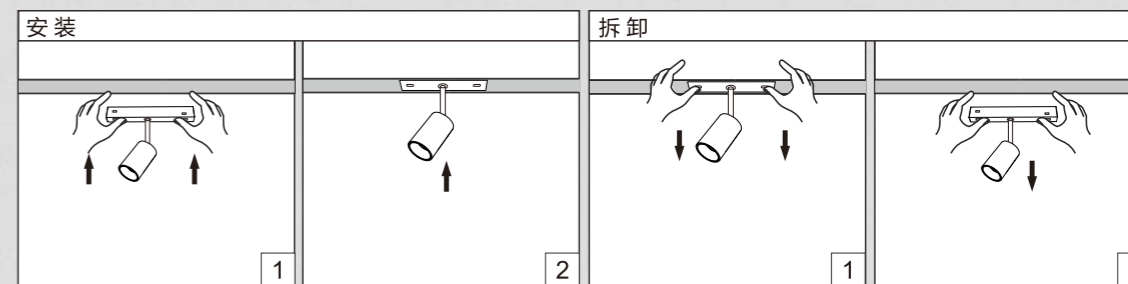
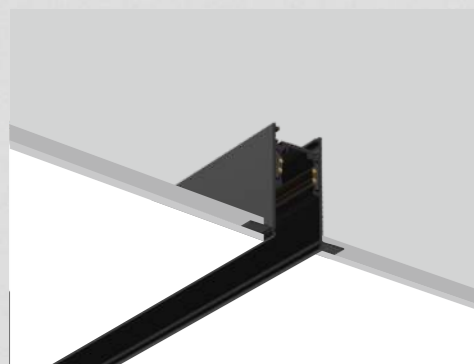
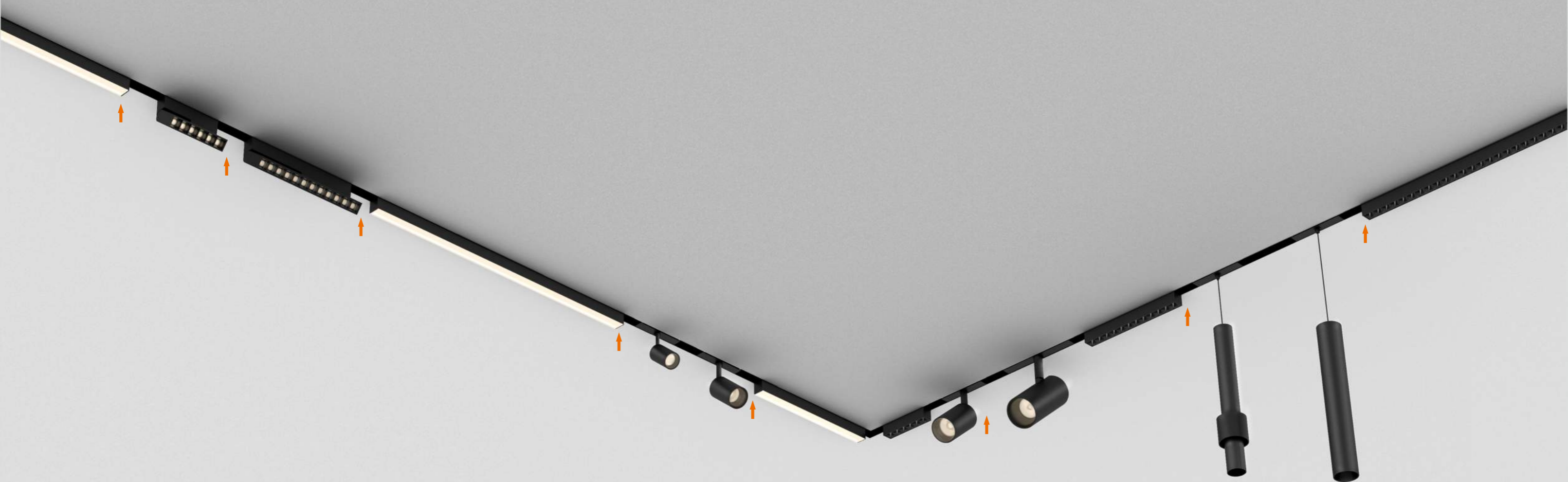

I TYPE Lighting System

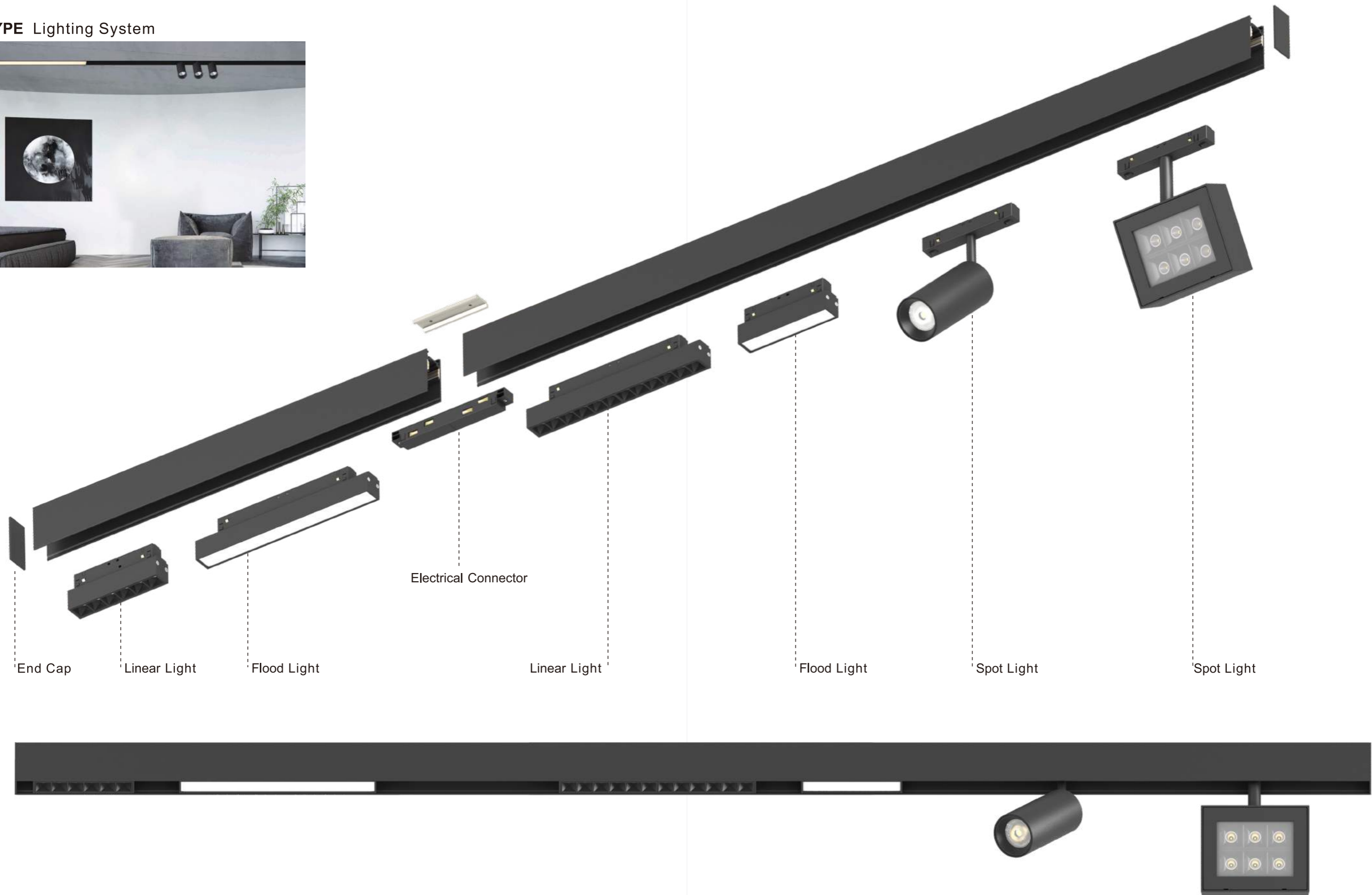

End Cap

Linear Light

Flood Light

Electrical Connector

Linear Light

Flood Light

Spot Light

Spot Light

Z TYPE Lighting System

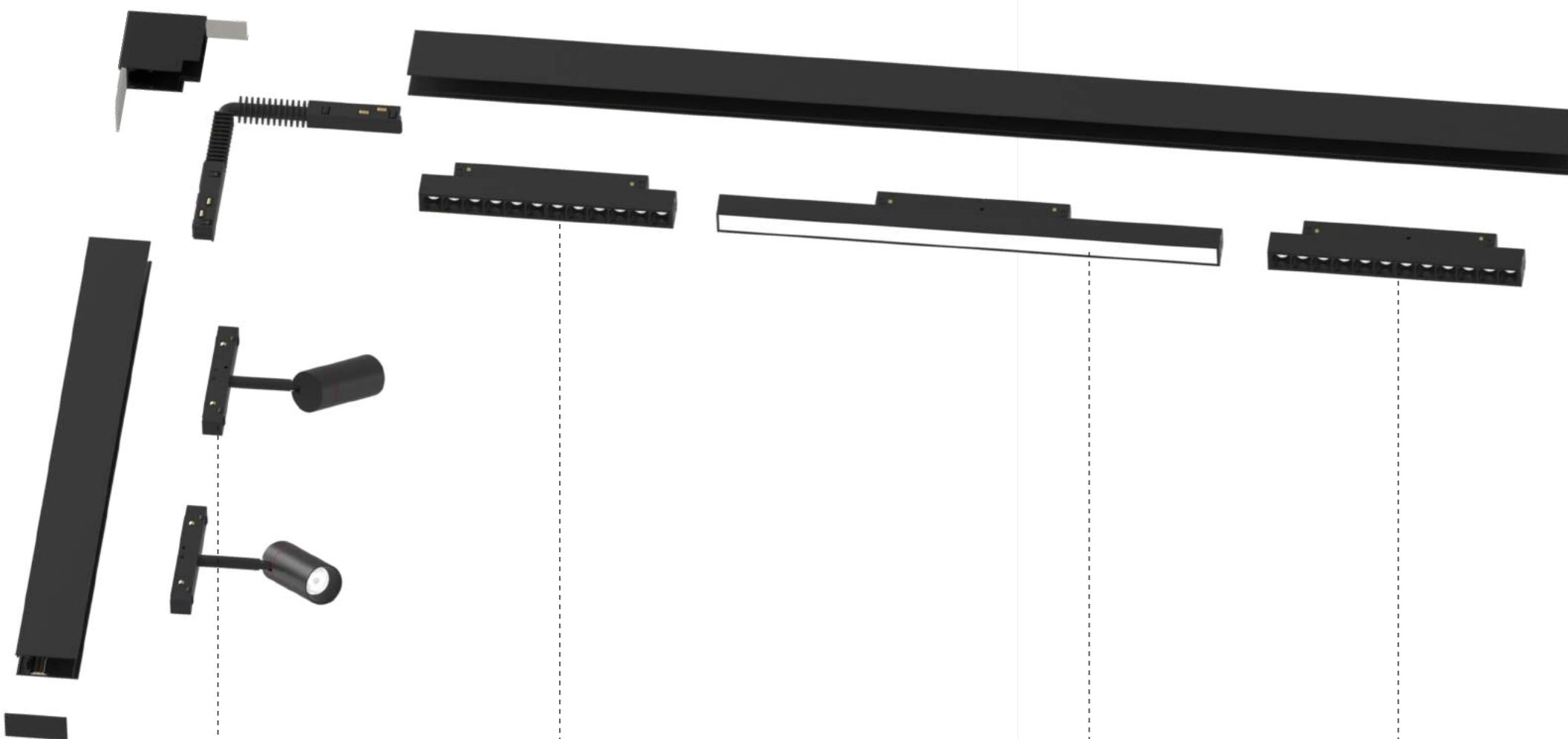

Spot Light

Linear Light

Flood Light

Linear Light



T TYPE Lighting System

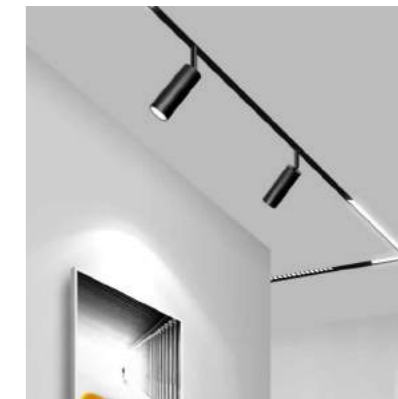
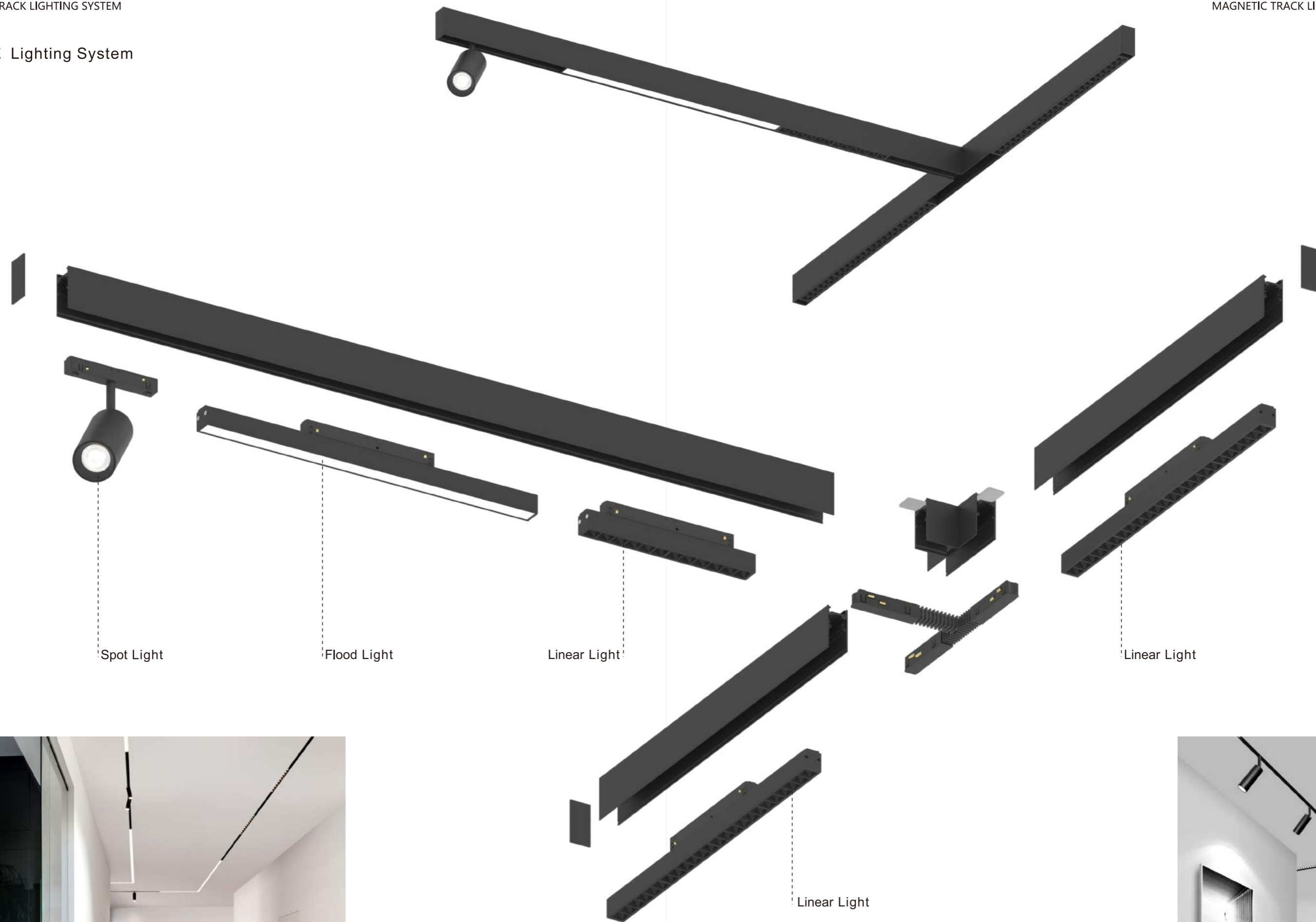

+ TYPE Lighting System

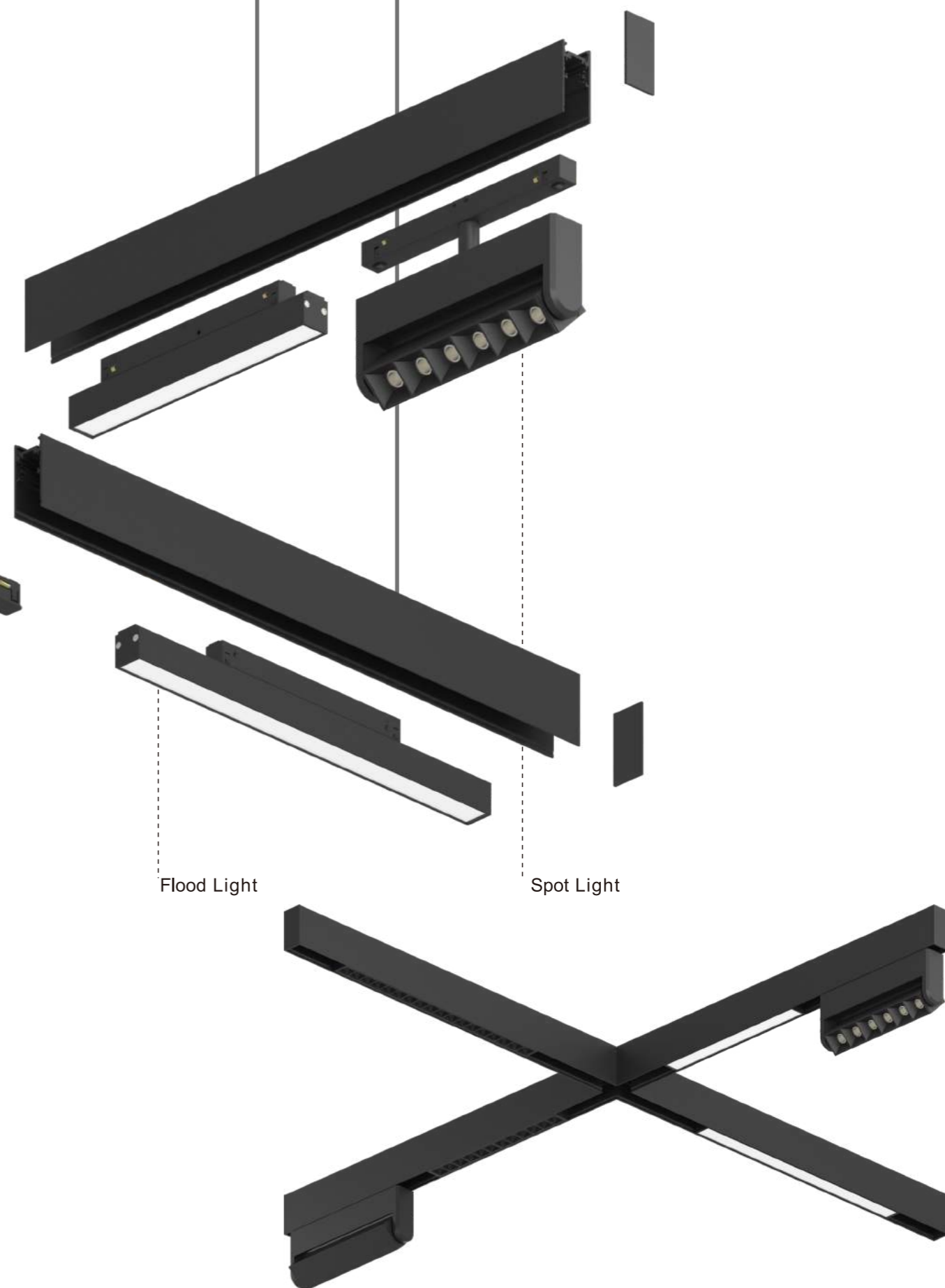
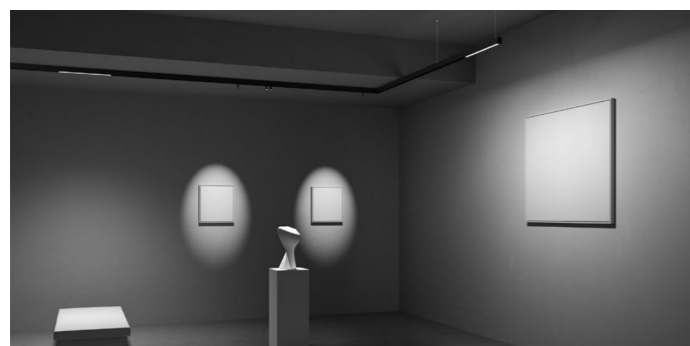
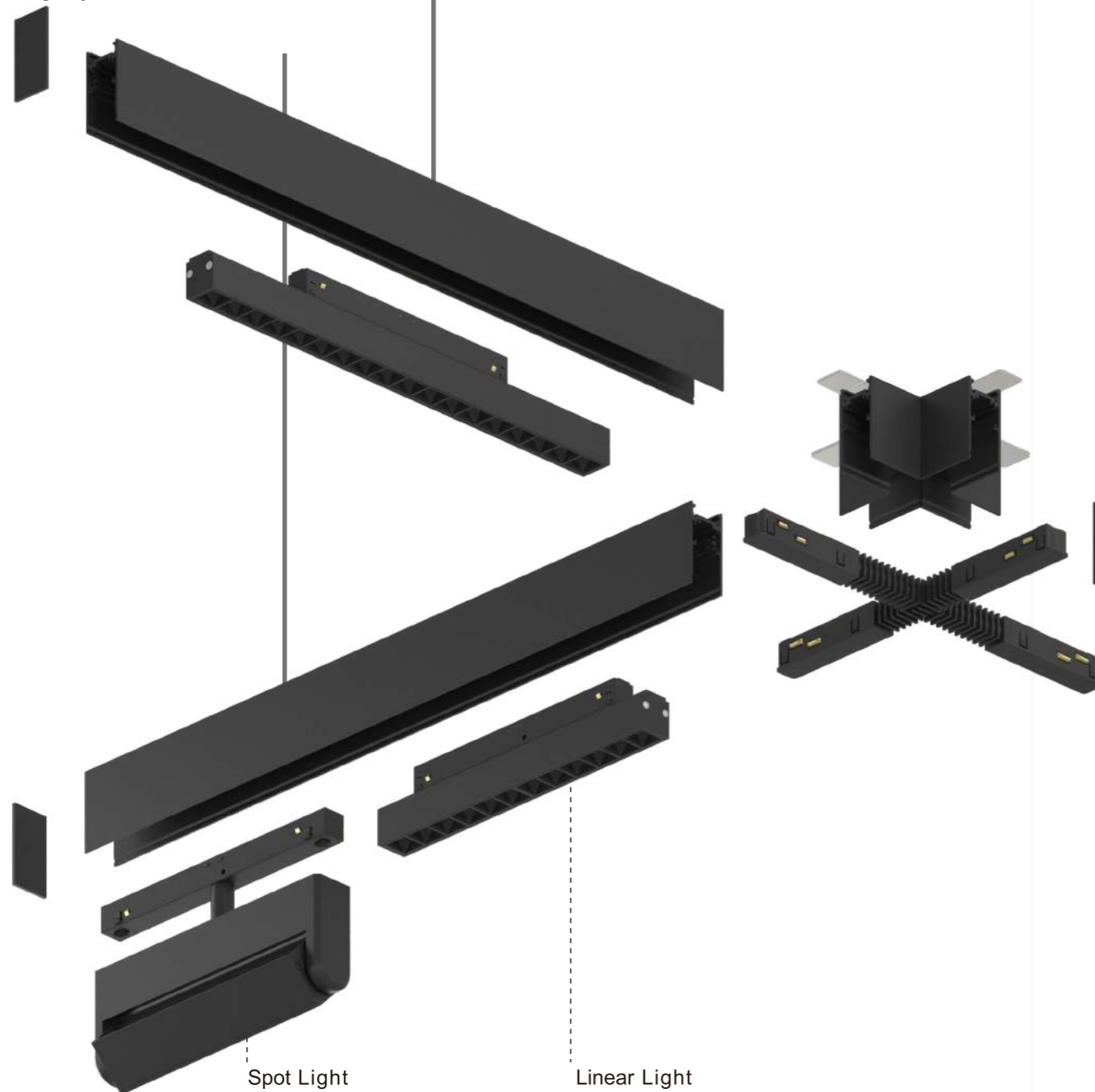



△ TYPE Lighting System





□ TYPE Lighting System

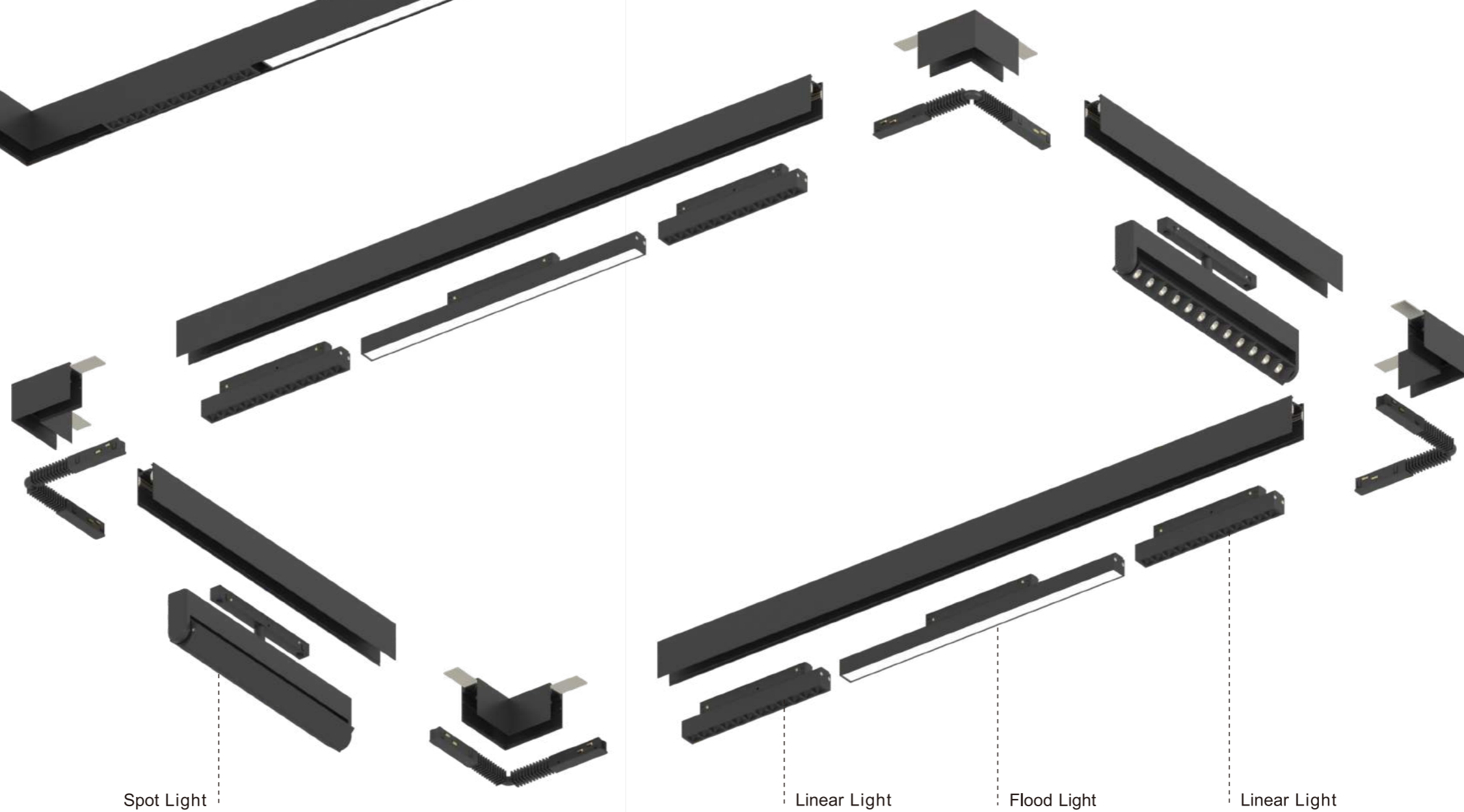
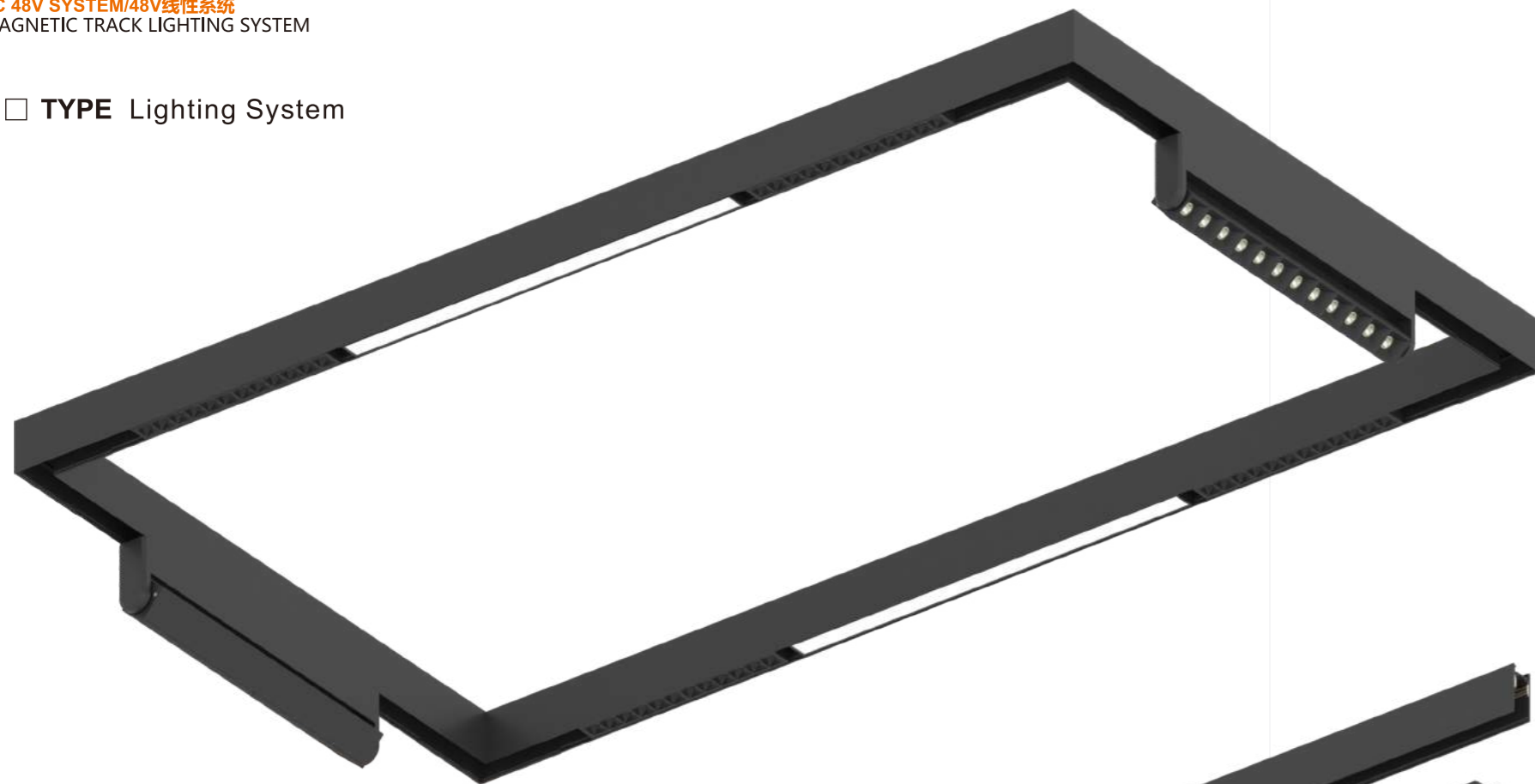

Spot Light

Linear Light

Flood Light

Linear Light



## Spotlight Series 射灯照明系列

Flexible and adjustable, horizontal 360° adjustable/vertical 90° adjustable.  
Supportable anti-glare Track System: honey comb/ Soft Lens/stripe/Square.  
3W/5W/6W/10W/14W/18W/20W/28W.

灵活可动，水平 360° 可调节 / 垂直 90° 可调节；  
可支持防眩配件：蜂窝网格，柔光片。

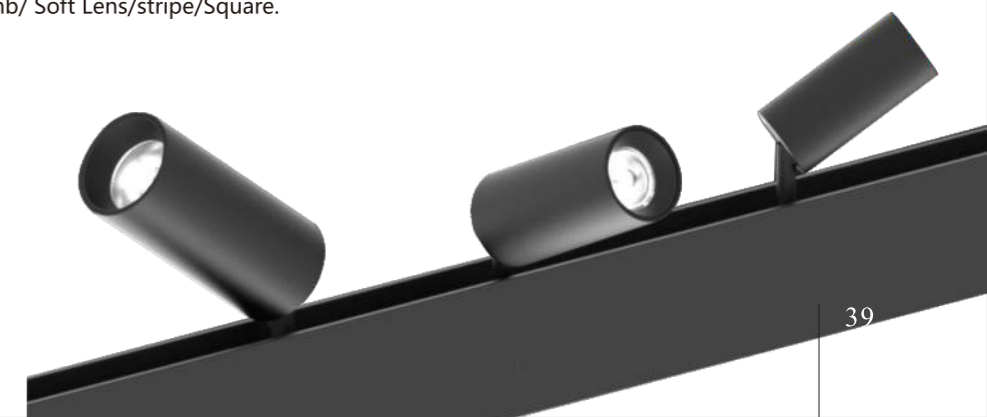



Reference Information

Model No.	System Power (W)	Beam Angle (°)	Luminous Flux (LM)	CCT (K)	CRI	Color
<b>VX-8134</b>	3W	15°/30°/45°	240LM	2700/3000/3500/4000K	80/90/97	WH BL GR

Light Distribution

3W 3000K

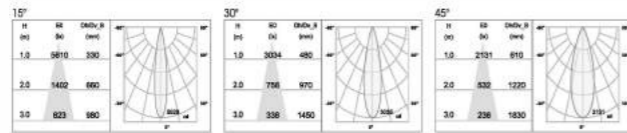

Intelligent Control

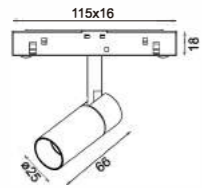
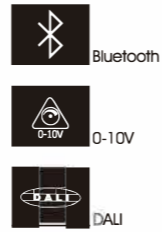

Track System



Reference Information

Model No.	System Power (W)	Beam Angle (°)	Luminous Flux (LM)	CCT (K)	CRI	Color
<b>VX-8134D</b>	2x3W	15°/30°/45°	2x240LM	2700/3000/3500/4000K	80/90/97	WH BL GR

Light Distribution

3W 3000K

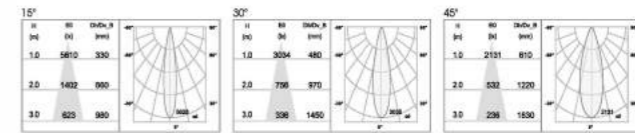

Intelligent Control

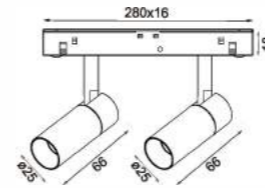
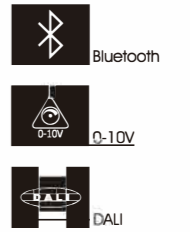

Track System

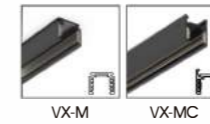

Reference Information

Model No.	System Power (W)	Beam Angle (°)	Luminous Flux (LM)	CCT (K)	CRI	Color
<b>VX-9134</b>	3W	15°/30°/45°	240LM	2700/3000/3500/4000K	80/90/97	WH BL GR

Light Distribution

3W 3000K

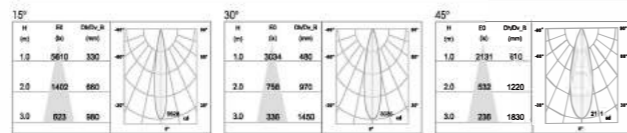

Intelligent Control

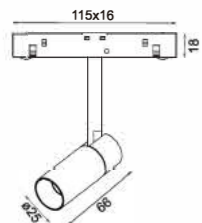
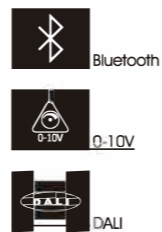

Track System

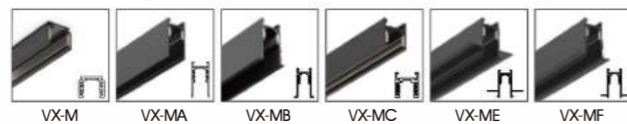

Reference Information

Model No.	System Power (W)	Beam Angle (°)	Luminous Flux (LM)	CCT (K)	CRI	Color
<b>VX-9134D</b>	2x3W	15°/30°/45°	2x240LM	2700/3000/3500/4000K	80/90/97	WH BL GR

Light Distribution

3W 3000K

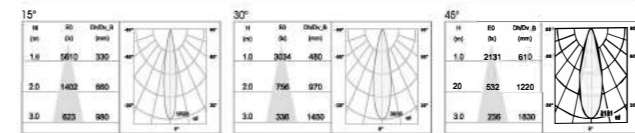

Intelligent Control

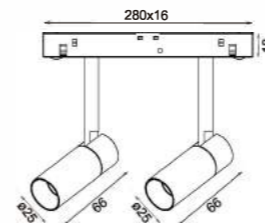
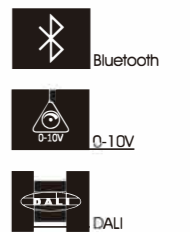

Track System

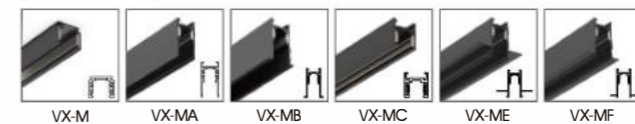



Reference Information

Model No.	System Power (W)	Beam Angle (°)	Luminous Flux (LM)	CCT (K)	CRI	Color
<b>VX-8135</b>	5W	15°/24°/36°	400LM	2700/3000/3500/4000K	80/90/97	WH BL GR

Light Distribution

5W 3000K

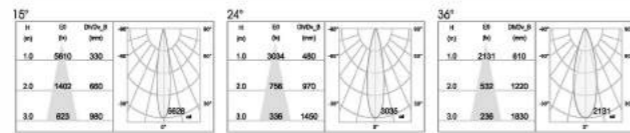

Intelligent Control

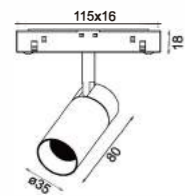
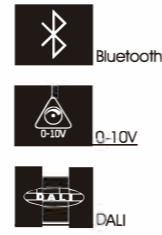

Track System

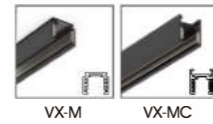

Reference Information

Model No.	System Power (W)	Beam Angle (°)	Luminous Flux (LM)	CCT (K)	CRI	Color
<b>VX-8135D</b>	2x5W	15°/24°/36°	2x400LM	2700/3000/3500/4000K	80/90/97	WH BL GR

Light Distribution

5W 3000K

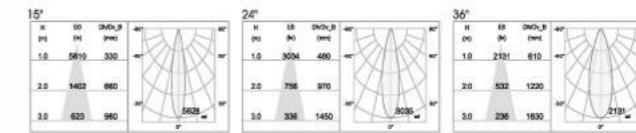

Intelligent Control

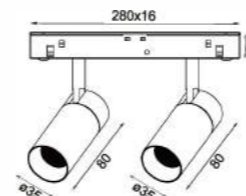
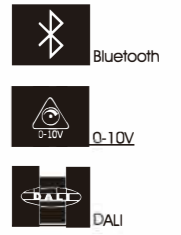

Track System

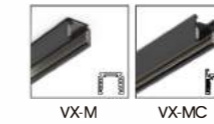

Reference Information

Model No.	System Power (W)	Beam Angle (°)	Luminous Flux (LM)	CCT (K)	CRI	Color
<b>VX-9135</b>	5W	15°/24°/36°	400LM	2700/3000/3500/4000K	80/90/97	WH BL GR

Light Distribution

5W 3000K

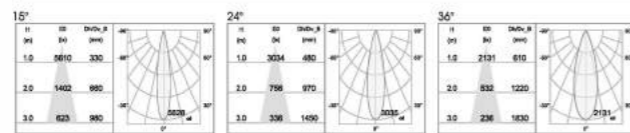

Intelligent Control

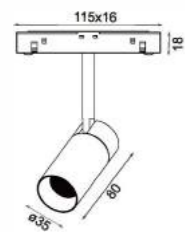

Track System

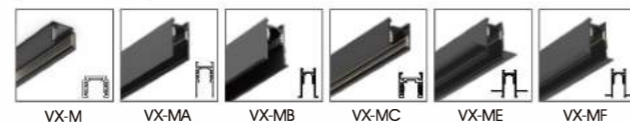

Reference Information

Model No.	System Power (W)	Beam Angle (°)	Luminous Flux (LM)	CCT (K)	CRI	Color
<b>VX-9135D</b>	2x5W	15°/24°/36°	2x400LM	2700/3000/3500/4000K	80/90/97	WH BL GR

Light Distribution

5W 3000K

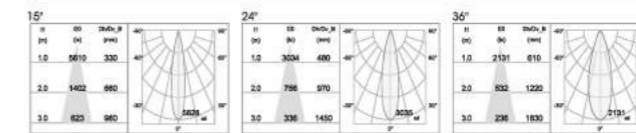

Intelligent Control

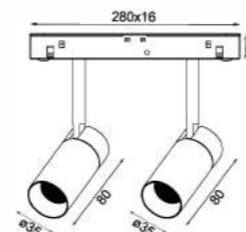
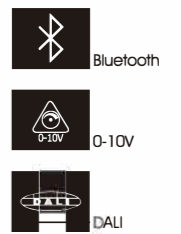

Track System

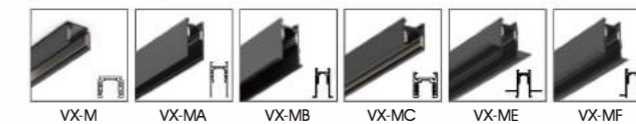



Reference Information

Model No.	System Power (W)	Beam Angle (°)	Luminous Flux (LM)	CCT (K)	CRI	Color
VX-8121	6W	20°/30°	480LM	2700/3000/3500/4000K	80/90/97	WH BL GR

Light Distribution

6W 3000K

Intelligent Control

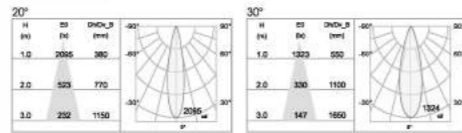

- Bluetooth
- 0-10V
- DALI

Track System

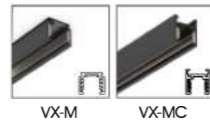

VX-M VX-MC

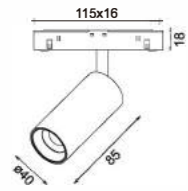

Reference Information

Model No.	System Power (W)	Beam Angle (°)	Luminous Flux (LM)	CCT (K)	CRI	Color
VX-8121D	2x6W	20°/30°	2x480LM	2700/3000/3500/4000K	80/90/97	WH BL GR

Light Distribution

6W 3000K

Intelligent Control

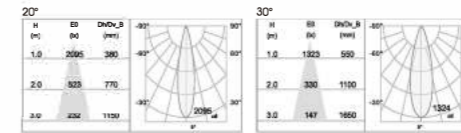

- Bluetooth
- 0-10V
- DALI

Track System



VX-M VX-MC

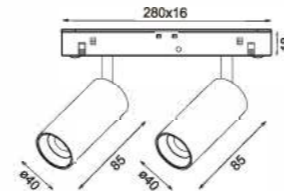

Reference Information

Model No.	System Power (W)	Beam Angle (°)	Luminous Flux (LM)	CCT (K)	CRI	Color
VX-9121	6W	20°/30°	480LM	2700/3000/3500/4000K	80/90/97	WH BL GR

Light Distribution

6W 3000K

Intelligent Control

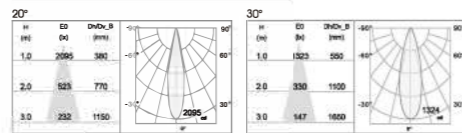

- Bluetooth
- 0-10V
- DALI

Track System

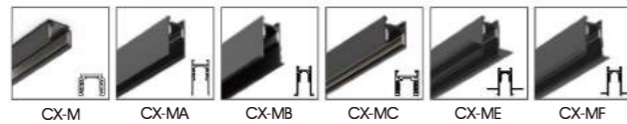

CX-M CX-MA CX-MB CX-MC CX-ME CX-MF

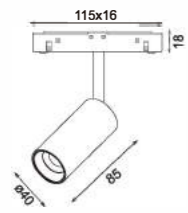

Reference Information

Model No.	System Power (W)	Beam Angle (°)	Luminous Flux (LM)	CCT (K)	CRI	Color
VX-9121D	2x6W	20°/30°	2x480LM	2700/3000/3500/4000K	80/90/97	WH BL GR

Light Distribution

6W 3000K

Intelligent Control

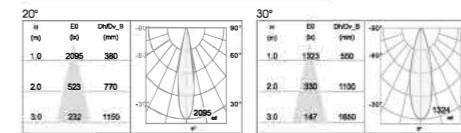

- Bluetooth
- 0-10V
- DALI

Track System

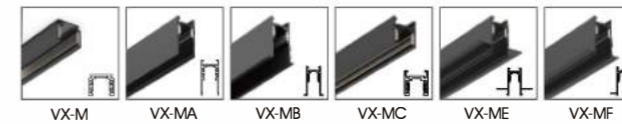

VX-M VX-MA VX-MB VX-MC VX-ME VX-MF

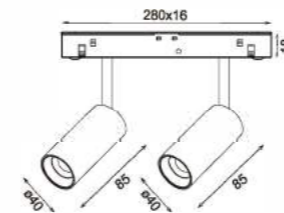



Reference Information

Model No.	System Power (W)	Beam Angle (°)	Luminous Flux (LM)	CCT (K)	CRI	Color
<b>VX-8122</b>	10W	18°/24°/36°	800LM	2700/3000/3500/4000K	80/90/97	WH BL GR

Light Distribution

10W 3000K

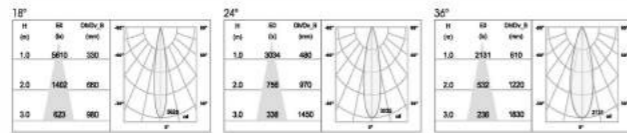

Intelligent Control

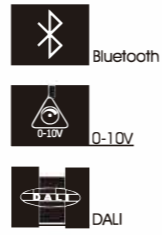

Track System

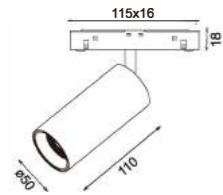
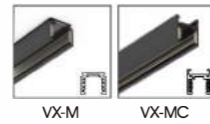

Reference Information

Model No.	System Power (W)	Beam Angle (°)	Luminous Flux (LM)	CCT (K)	CRI	Color
<b>VX-8122D</b>	2x10W	18°/24°/36°	2x800LM	2700/3000/3500/4000K	80/90/97	WH BL GR

Light Distribution

10W 3000K

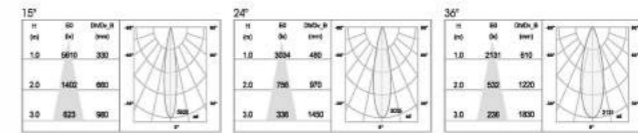

Intelligent Control

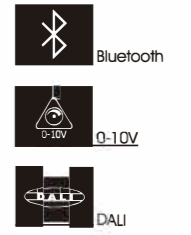

Track System

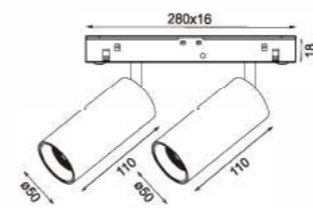
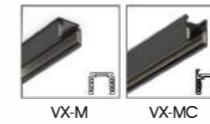

Reference Information

Model No.	System Power (W)	Beam Angle (°)	Luminous Flux (LM)	CCT (K)	CRI	Color
<b>VX-9122</b>	10W	18°/24°/36°	800LM	2700/3000/3500/4000K	80/90/97	WH BL GR

Light Distribution

10W 3000K

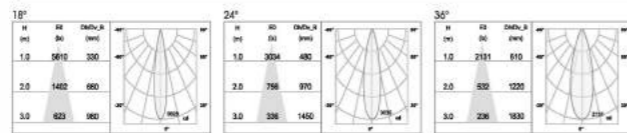

Intelligent Control

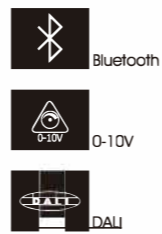

Track System

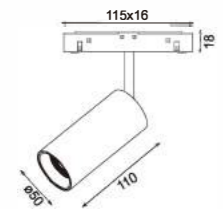
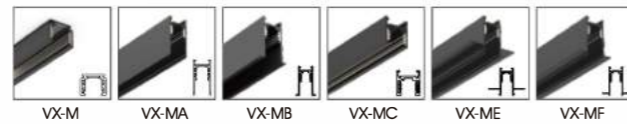

Reference Information

Model No.	System Power (W)	Beam Angle (°)	Luminous Flux (LM)	CCT (K)	CRI	Color
<b>VX-9122D</b>	2x10W	18°/24°/36°	2x800LM	2700/3000/3500/4000K	80/90/97	WH BL GR

Light Distribution

10W 3000K

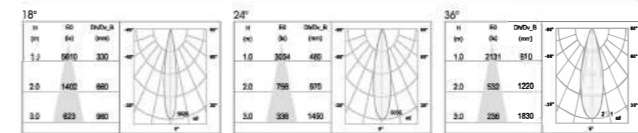

Intelligent Control

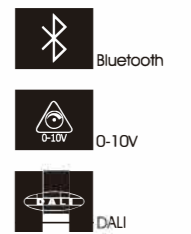

Track System

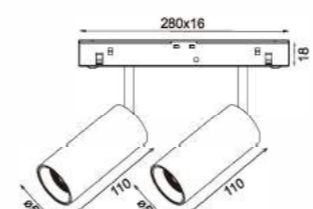
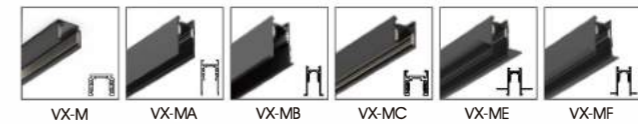



Reference Information

Model No.	System Power (W)	Beam Angle (°)	Luminous Flux (LM)	CCT (K)	CRI	Color
<b>VX-8123</b>	15W	20°/24°/36°	1200LM	2700/3000/3500/4000K	80/90/97	WH BL GR

Light Distribution

15W 3000K

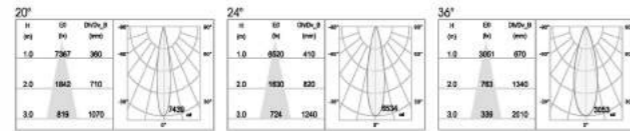

Intelligent Control

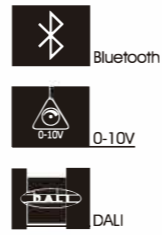

Track System

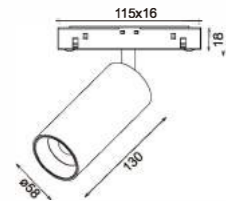
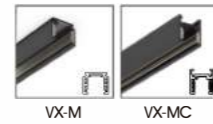

Reference Information

Model No.	System Power (W)	Beam Angle (°)	Luminous Flux (LM)	CCT (K)	CRI	Color
<b>VX-8123D</b>	2x15W	20°/24°/36°	2x1200LM	2700/3000/3500/4000K	80/90/97	WH BL GR

Light Distribution

15W 3000K

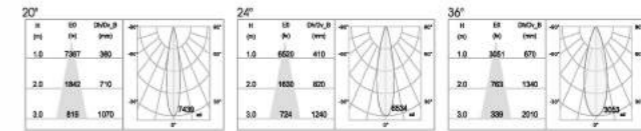

Intelligent Control

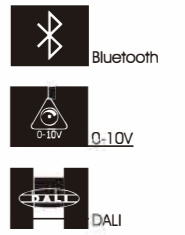

Track System

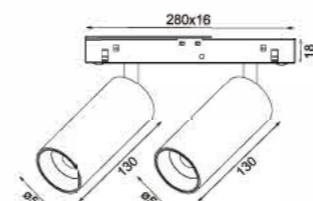
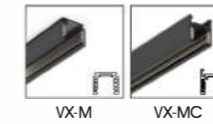

Reference Information

Model No.	System Power (W)	Beam Angle (°)	Luminous Flux (LM)	CCT (K)	CRI	Color
<b>VX-9123</b>	15W	20°/24°/36°	1200LM	2700/3000/3500/4000K	80/90/97	WH BL GR

Light Distribution

15W 3000K

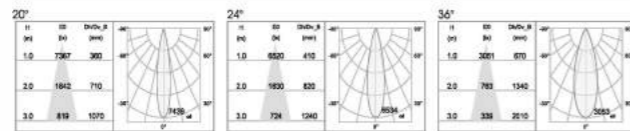

Intelligent Control

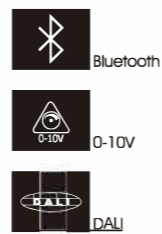

Track System

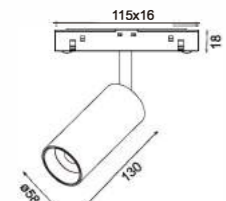
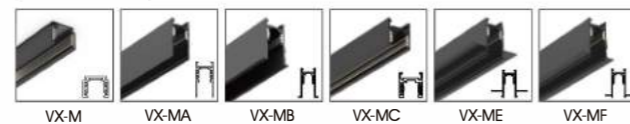

Reference Information

Model No.	System Power (W)	Beam Angle (°)	Luminous Flux (LM)	CCT (K)	CRI	Color
<b>VX-9123D</b>	2x15W	20°/24°/36°	2x1200LM	2700/3000/3500/4000K	80/90/97	WH BL GR

Light Distribution

15W 3000K

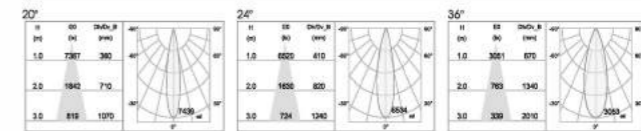

Intelligent Control

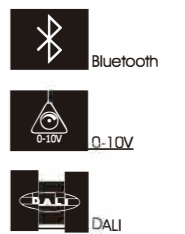

Track System

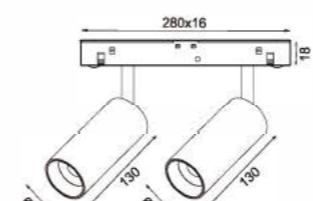
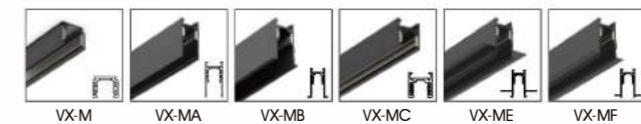



Reference Information

Model No.	System Power (W)	Beam Angle (°)	Luminous Flux (LM)	CCT (K)	CRI	Color
VX-8124	20W	15°/24°/36°	1600LM	2700/3000/3500/4000K	80/90/97	WH BL GR

Light Distribution

20W 3000K

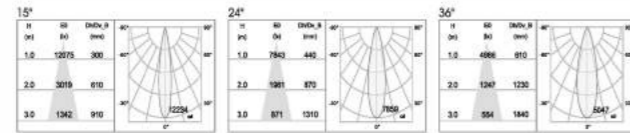

Intelligent Control

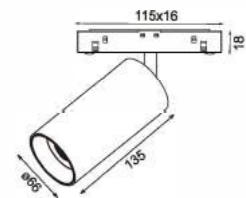
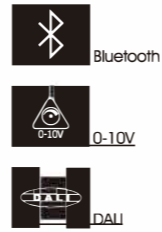

Track System

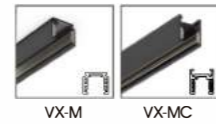

Reference Information

Model No.	System Power (W)	Beam Angle (°)	Luminous Flux (LM)	CCT (K)	CRI	Color
VX-8124D	2x20W	15°/24°/36°	2x1600LM	2700/3000/3500/4000K	80/90/97	WH BL GR

Light Distribution

20W 3000K

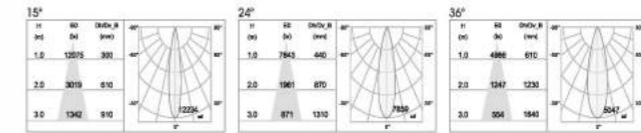

Intelligent Control

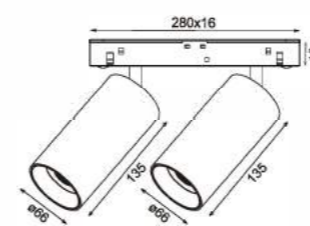
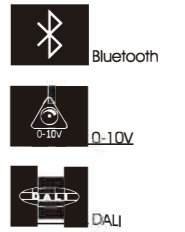

Track System

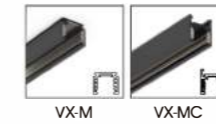

Reference Information

Model No.	System Power (W)	Beam Angle (°)	Luminous Flux (LM)	CCT (K)	CRI	Color
VX-9124	20W	15°/24°/36°	1600LM	2700/3000/3500/4000K	80/90/97	WH BL GR

Light Distribution

20W 3000K

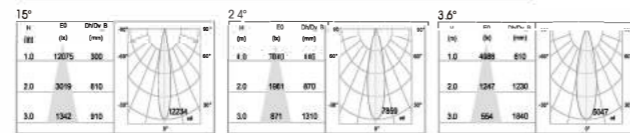

Intelligent Control

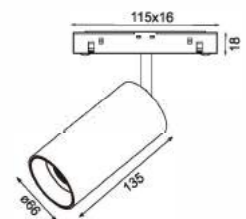
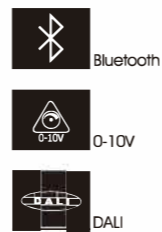

Track System

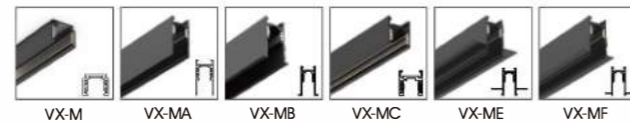

Reference Information

Model No.	System Power (W)	Beam Angle (°)	Luminous Flux (LM)	CCT (K)	CRI	Color
VX-9124D	2x20W	15°/24°/36°	2x1600LM	2700/3000/3500/4000K	80/90/97	WH BL GR

Light Distribution

20W 3000K

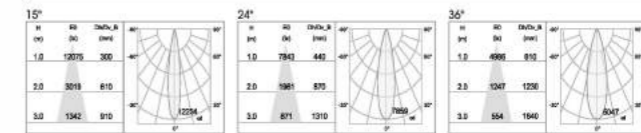

Intelligent Control

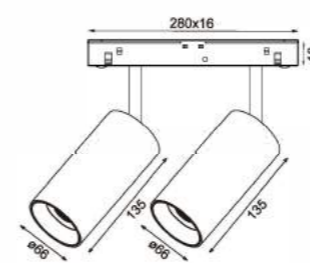
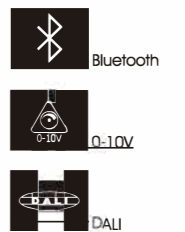

Track System

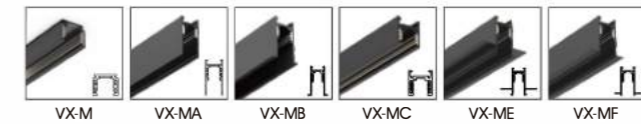





Reference Information

Model No.	System Power (W)	Beam Angle (°)	Luminous Flux (LM)	CCT (K)	CRI	Color
VX-8125	28W	20°/30°/40°	2240LM	2700/3000/3500/4000K	80/90/97	WH BL GR

Light Distribution

28W 3000K

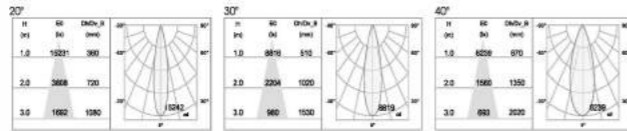

Intelligent Control

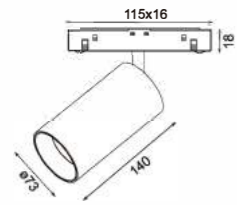
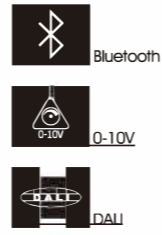

Track System

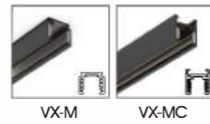

Reference Information

Model No.	System Power (W)	Beam Angle (°)	Luminous Flux (LM)	CCT (K)	CRI	Color
VX-9125	28W	20°/30°/40°	2240LM	2700/3000/3500/4000K	80/90/97	WH BL GR

Light Distribution

28W 3000K

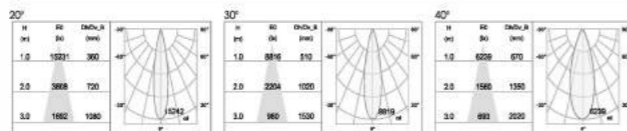

Intelligent Control

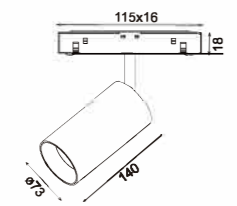
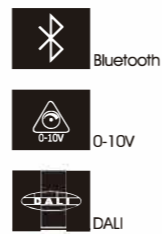

Track System

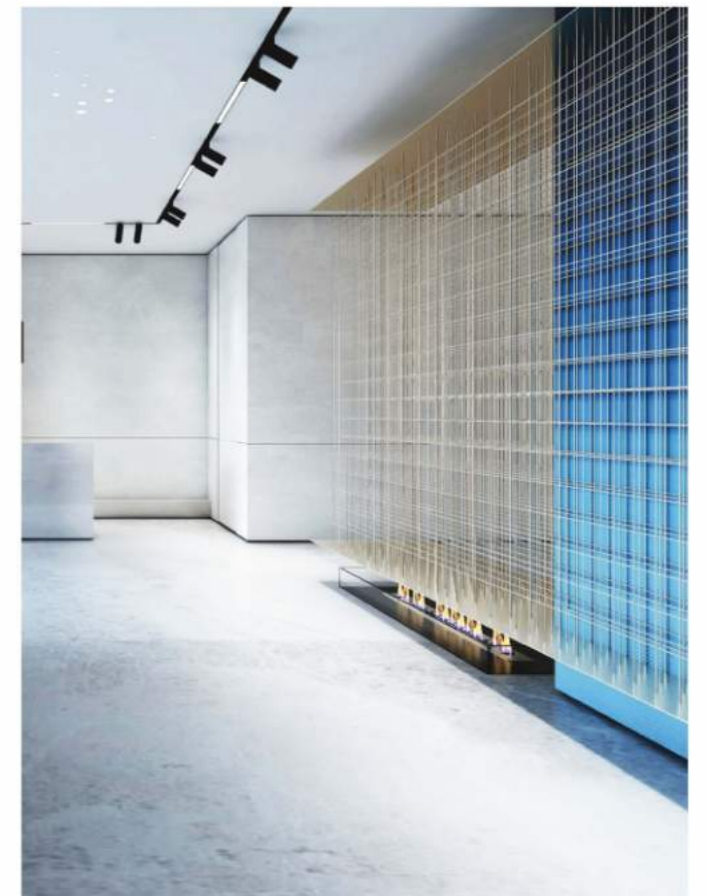
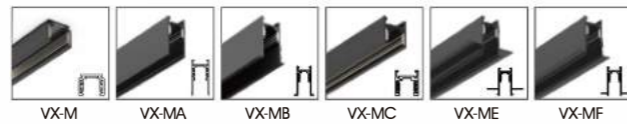



Reference Information

Model No.	System Power (W)	Beam Angle (°)	Luminous Flux (LM)	CCT (K)	CRI	Color
VX-8132	10W	18°/24°/36°	800LM	2700/3000/3500/4000K	80/90/97	WH BL GR

Light Distribution

10W 3000K

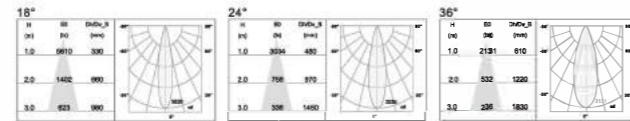

Intelligent Control

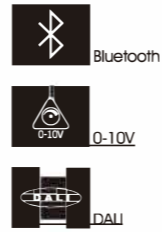

Track System

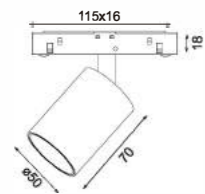
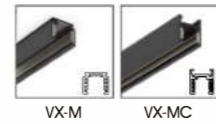

Reference Information

Model No.	System Power (W)	Beam Angle (°)	Luminous Flux (LM)	CCT (K)	CRI	Color
VX-8132D	2x10W	18°/24°/36°	2x800LM	2700/3000/3500/4000K	80/90/97	WH BL GR

Light Distribution

10W 3000K

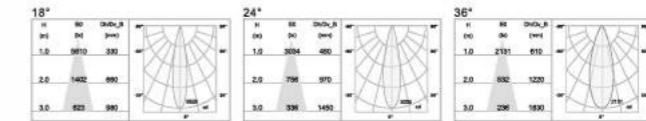

Intelligent Control

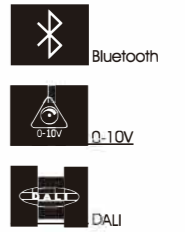

Track System

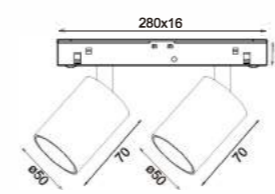
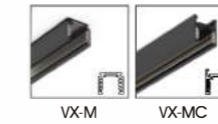

Reference Information

Model No.	System Power (W)	Beam Angle (°)	Luminous Flux (LM)	CCT (K)	CRI	Color
VX-9132	10W	18°/24°/36°	800LM	2700/3000/3500/4000K	80/90/97	WH BL GR

Light Distribution

10W 3000K

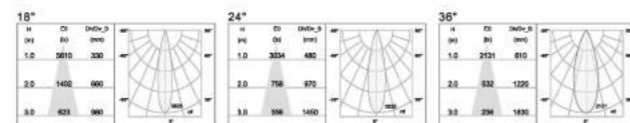

Intelligent Control

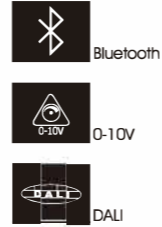

Track System

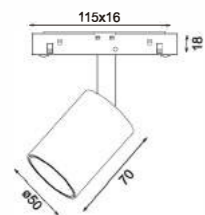
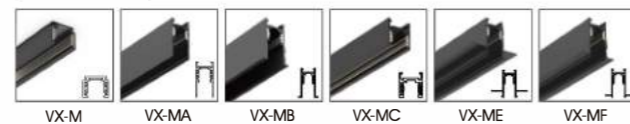

Reference Information

Model No.	System Power (W)	Beam Angle (°)	Luminous Flux (LM)	CCT (K)	CRI	Color
VX-9132D	2x10W	18°/24°/36°	2x800LM	2700/3000/3500/4000K	80/90/97	WH BL GR

Light Distribution

10W 3000K

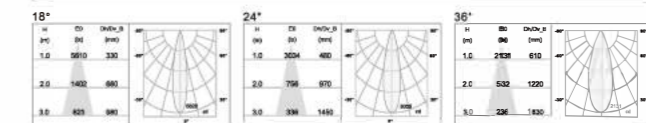

Intelligent Control

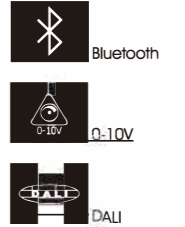

Track System

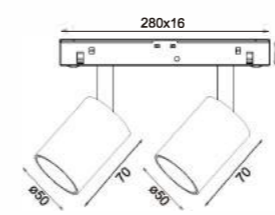
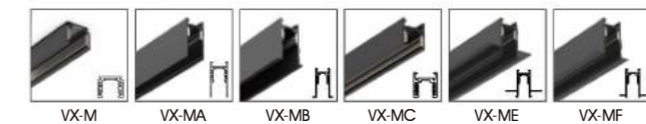

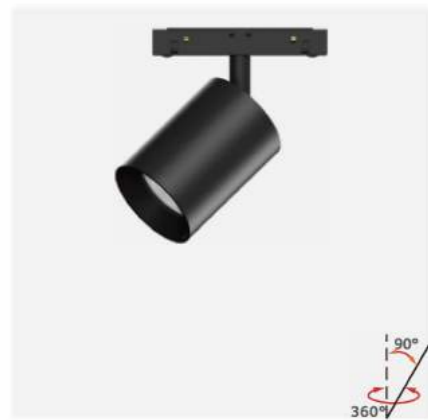

Reference Information

Model No.	System Power (W)	Beam Angle (°)	Luminous Flux (LM)	CCT (K)	CRI	Color
<b>VX-8133</b>	18W	15°/24°/36°	1440LM	2700/3000/3500/4000K	80/90/97	WH BL GR

Light Distribution

18W 3000K

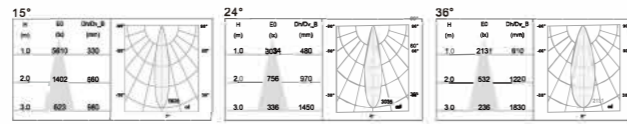

Intelligent Control

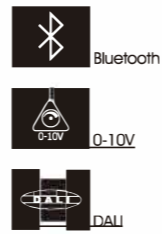

Track System

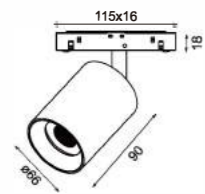
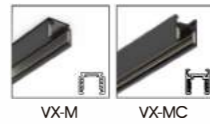

Reference Information

Model No.	System Power (W)	Beam Angle (°)	Luminous Flux (LM)	CCT (K)	CRI	Color
<b>VX-8133D</b>	2x18W	15°/24°/36°	2x1440LM	2700/3000/3500/4000K	80/90/97	WH BL GR

Light Distribution

18W 3000K

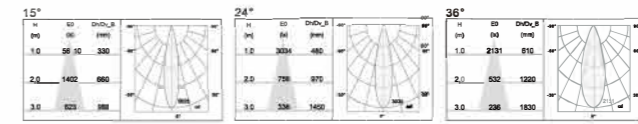

Intelligent Control

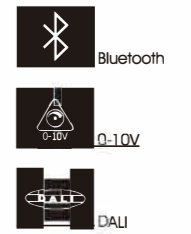

Track System

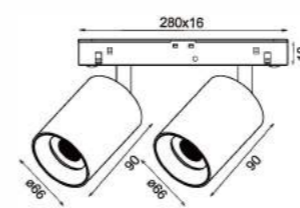

Reference Information

Model No.	System Power (W)	Beam Angle (°)	Luminous Flux (LM)	CCT (K)	CRI	Color
<b>VX-9133</b>	18W	15°/24°/36°	1440LM	2700/3000/3500/4000K	80/90/97	WH BL GR

Light Distribution

18W 3000K

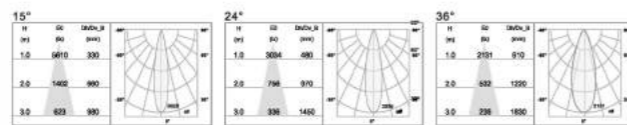

Intelligent Control

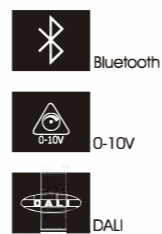

Track System

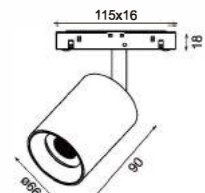
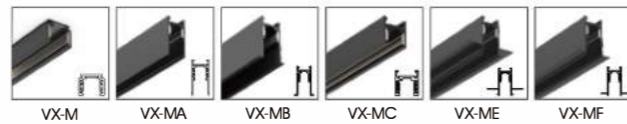

Reference Information

Model No.	System Power (W)	Beam Angle (°)	Luminous Flux (LM)	CCT (K)	CRI	Color
<b>VX-9133D</b>	2x18W	15°/24°/36°	2x1440LM	2700/3000/3500/4000K	80/90/97	WH BL GR

Light Distribution

18W 3000K

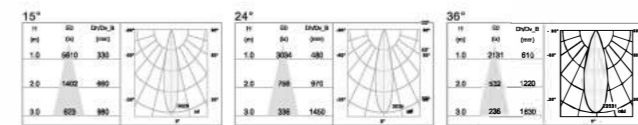

Intelligent Control

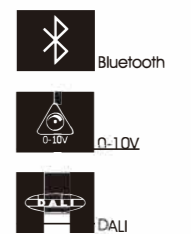

Track System

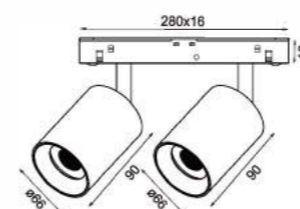
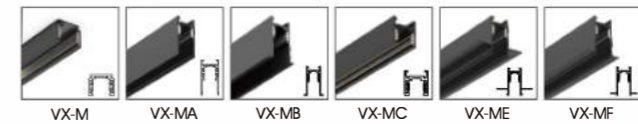



Reference Information

Model No.	System Power (W)	Beam Angle (°)	Luminous Flux (LM)	CCT (K)	CRI	Color
<b>VX-8138</b>	20W	12°/24°/36°	1600LM	2700/3000/3500/4000K	80/90/97	WH BL GR

Light Distribution

20W 3000K

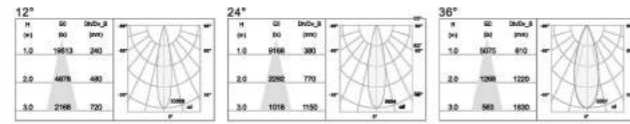

Intelligent Control

- Bluetooth
- 0-10V
- DALI

Track System

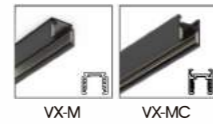

VX-M

VX-MC

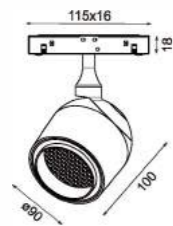

Reference Information

Model No.	System Power (W)	Beam Angle (°)	Luminous Flux (LM)	CCT (K)	CRI	Color
<b>VX-9138</b>	20W	12°/24°/36°	1600LM	2700/3000/3500/4000K	80/90/97	WH BL GR

Light Distribution

20W 3000K

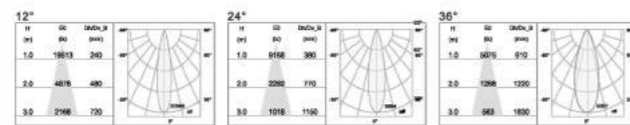

Intelligent Control

- Bluetooth
- 0-10V
- DALI

Track System

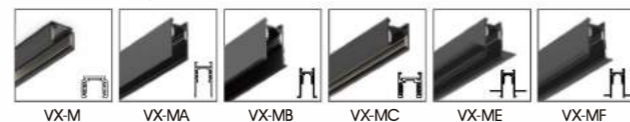

VX-M

VX-MA

VX-MB

VX-MC

VX-ME

VX-MF





## Square Spotlight Series

Array arrangement consisting of multiple beads. Effectively reduce glare.  
Flexible and adjustable, horizontal 360° adjustable/vertical 90° adjustable.

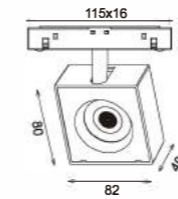

### Reference Information

Model No.	System Power (W)	Beam Angle (°)	Luminous Flux (LM)	CCT (K)	CRI	Color
<b>VX-8128</b>	14W	15°/24°/36°	1120LM	2700/3000/3500/4000K	80/90/97	WH BL GR

### Light Distribution

14W 3000K

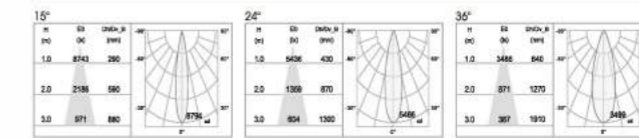

### Intelligent Control

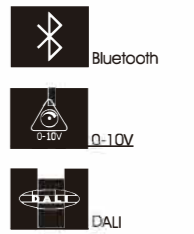

### Track System

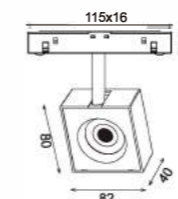
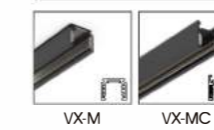

### Reference Information

Model No.	System Power (W)	Beam Angle (°)	Luminous Flux (LM)	CCT (K)	CRI	Color
<b>VX-9128</b>	14W	15°/24°/36°	1120LM	2700/3000/3500/4000K	80/90/97	WH BL GR

### Light Distribution

14W 3000K

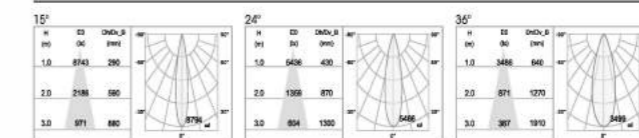

### Intelligent Control

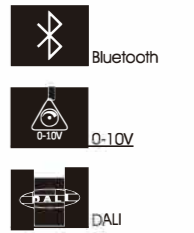

### Track System

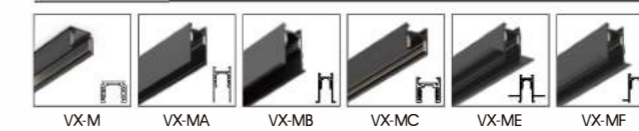

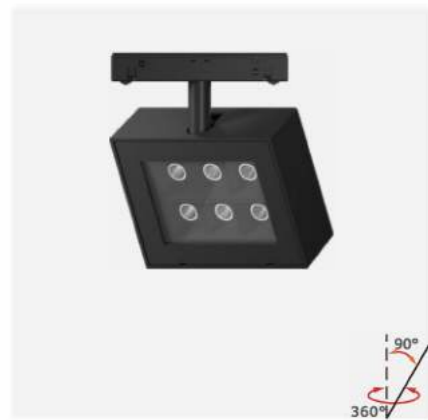

Reference Information

Model No.	System Power (W)	Beam Angle (°)	Luminous Flux (LM)	CCT (K)	CRI	Color
<b>VX-8127</b>	18W	15°/35°/48°	1260LM	2700/3000/3500/4000K	80/90/97	WH BL GR

Light Distribution

18W 3000K

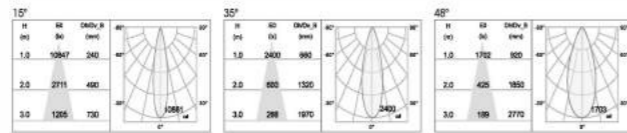

Intelligent Control

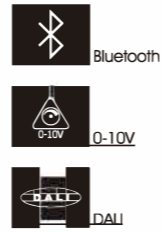

Track System

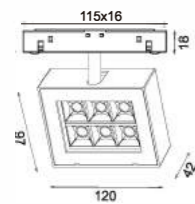
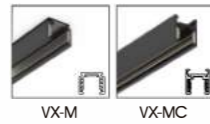

Reference Information

Model No.	System Power (W)	Beam Angle (°)	Luminous Flux (LM)	CCT (K)	CRI	Color
<b>VX-8126</b>	20W	15°/24°/36°	1600LM	2700/3000/3500/4000K	80/90/97	WH BL GR

Light Distribution

20W 3000K

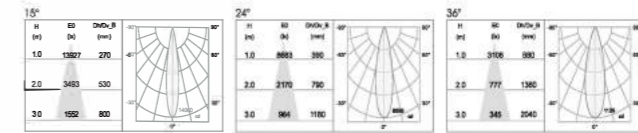

Intelligent Control

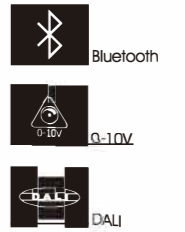

Track System

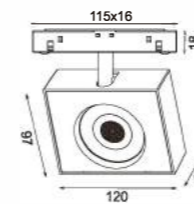
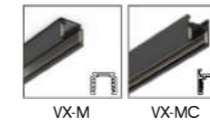

Reference Information

Model No.	System Power (W)	Beam Angle (°)	Luminous Flux (LM)	CCT (K)	CRI	Color
<b>VX-9127</b>	18W	15°/35°/48°	1260LM	2700/3000/3500/4000K	80/90/97	WH BL GR

Light Distribution

18W 3000K

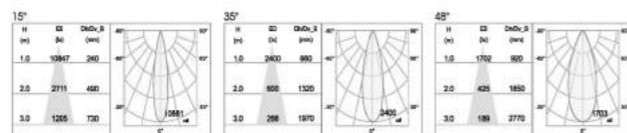

Intelligent Control

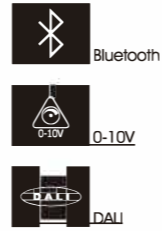

Track System

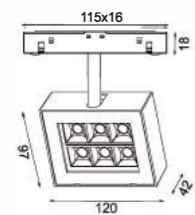
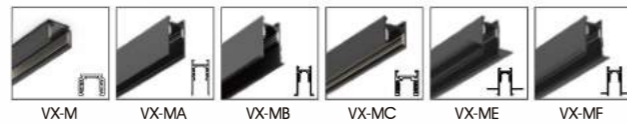

Reference Information

Model No.	System Power (W)	Beam Angle (°)	Luminous Flux (LM)	CCT (K)	CRI	Color
<b>VX-9126</b>	20W	15°/24°/36°	1600LM	2700/3000/3500/4000K	80/90/97	WH BL GR

Light Distribution

20W 3000K

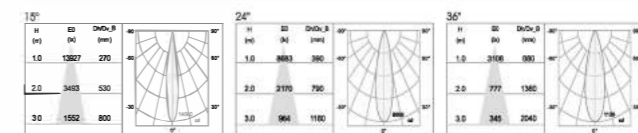

Intelligent Control



Track System

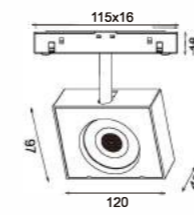
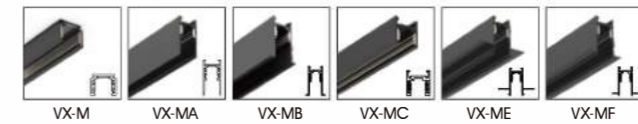



Reference Information

Model No.	System Power (W)	Beam Angle (°)	Luminous Flux (LM)	CCT (K)	CRI	Color
<b>VX-8136</b>	9W	12°/20°/35°	630LM	2700/3000/3500/4000K	80/90/97	WH BL GR

Light Distribution

9W 3000K

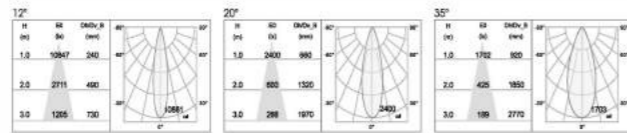

Intelligent Control

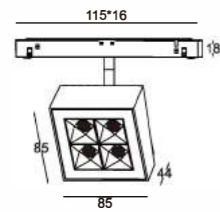

Track System



Reference Information

Model No.	System Power (W)	Beam Angle (°)	Luminous Flux (LM)	CCT (K)	CRI	Color
<b>VX-8137</b>	20W	12°/20°/35°	1400LM	2700/3000/3500/4000K	80/90/97	WH BL GR

Light Distribution

20W 3000K

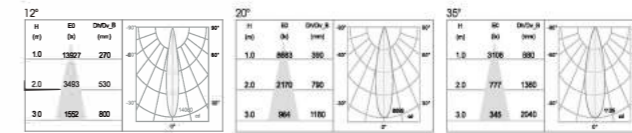

Intelligent Control

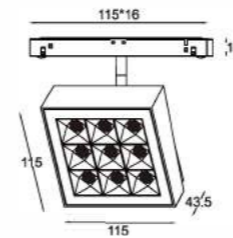

Track System

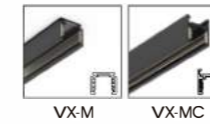

Reference Information

Model No.	System Power (W)	Beam Angle (°)	Luminous Flux (LM)	CCT (K)	CRI	Color
<b>VX-9136</b>	9W	12°/20°/35°	630LM	2700/3000/3500/4000K	80/90/97	WH BL GR

Light Distribution

9W 3000K

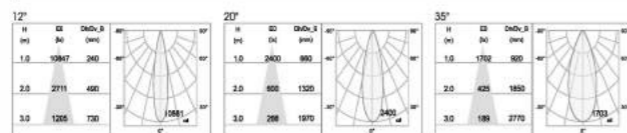

Intelligent Control

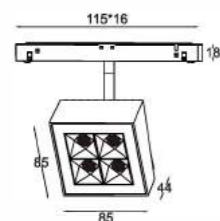

Track System

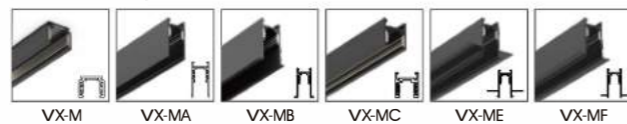

Reference Information

Model No.	System Power (W)	Beam Angle (°)	Luminous Flux (LM)	CCT (K)	CRI	Color
<b>VX-9137</b>	20W	12°/20°/35°	1400LM	2700/3000/3500/4000K	80/90/97	WH BL GR

Light Distribution

20W 3000K

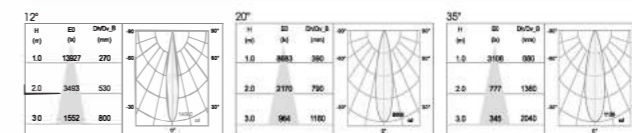

Intelligent Control

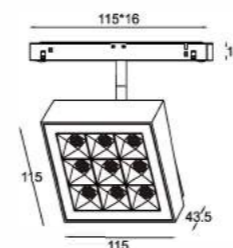

Track System

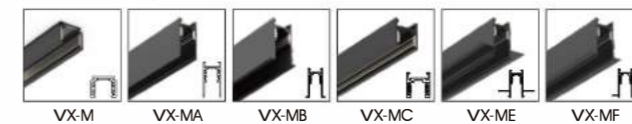

# Dimming

## 调焦照明系列

Power: 6W / 10W / 15W  
Diameter:  $\Phi$ 45mm /  $\Phi$ 55mm /  $\Phi$ 66mm



**15°**

Zoomable, accentuating varied sizes of objects with adjustable beam angle.

调焦方式，通过调节不同光束角度可突出不同大小的物体。



**60°**

Less than 20% attenuation of center light intensity from 15° to 60°. Provide flexible and precise lighting for home furnishing, shops, galleries and museums.

15° 至60°光束角调节中心光强度衰减小于20%。  
为家居、商店、画廊和博物馆提供灵活精确的照明。





Reference Information

Model No.	System Power (W)	Beam Angle (°)	Luminous Flux (LM)	CCT (K)	CRI	Color
VX-8129	6W	15°-45°	480LM	2700/3000/3500/4000K	80/90/97	WH BL GR

Light Distribution

6W 3000K

Intelligent Control

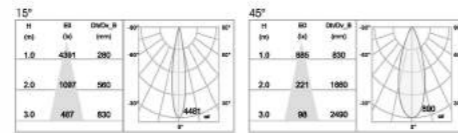

- Bluetooth
- 0-10V
- DALI

Track System

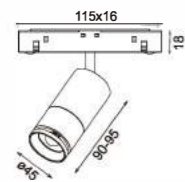
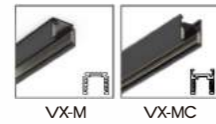

Reference Information

Model No.	System Power (W)	Beam Angle (°)	Luminous Flux (LM)	CCT (K)	CRI	Color
VX-8129D	2x6W	15°-45°	2x480LM	2700/3000/3500/4000K	80/90/97	WH BL GR

Light Distribution

6W 3000K

Intelligent Control

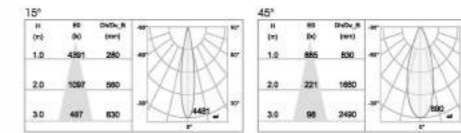

- Bluetooth
- 0-10V
- DALI

Track System

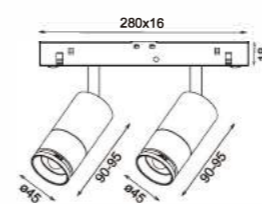
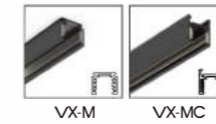

Reference Information

Model No.	System Power (W)	Beam Angle (°)	Luminous Flux (LM)	CCT (K)	CRI	Color
VX-9129	6W	15°-45°	480LM	2700/3000/3500/4000K	80/90/97	WH BL GR

Light Distribution

6W 3000K

Intelligent Control

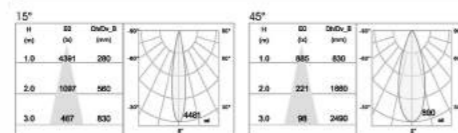

- Bluetooth
- 0-10V
- DALI

Track System

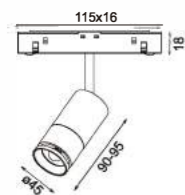
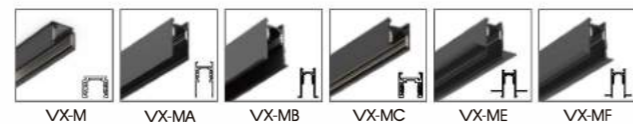

Reference Information

Model No.	System Power (W)	Beam Angle (°)	Luminous Flux (LM)	CCT (K)	CRI	Color
VX-9129D	2x6W	15°-45°	2x480LM	2700/3000/3500/4000K	80/90/97	WH BL GR

Light Distribution

6W 3000K

Intelligent Control

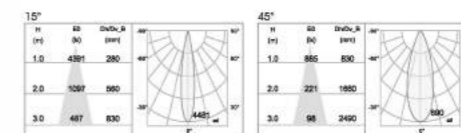

- Bluetooth
- 0-10V
- DALI

Track System

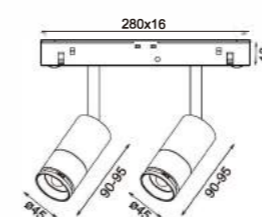
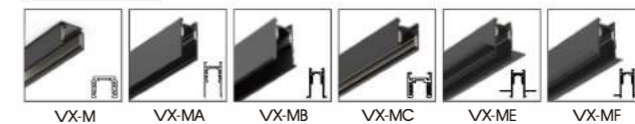



Reference Information

Model No.	System Power (W)	Beam Angle (°)	Luminous Flux (LM)	CCT (K)	CRI	Color
<b>VX-8130</b>	10W	15°-60°	800LM	2700/3000/3500/4000K	80/90/97	WH ● BL ● GR

Light Distribution

10W 3000K

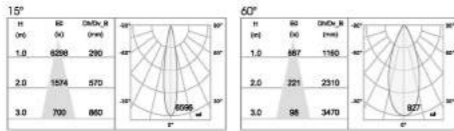

Intelligent Control

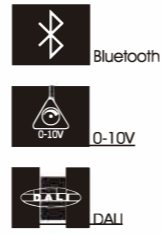

Track System

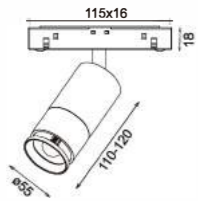
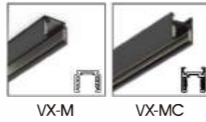

Reference Information

Model No.	System Power (W)	Beam Angle (°)	Luminous Flux (LM)	CCT (K)	CRI	Color
<b>VX-8130D</b>	2x10W	15°-60°	2x800LM	2700/3000/3500/4000K	80/90/97	WH ● BL ● GR

Light Distribution

10W 3000K

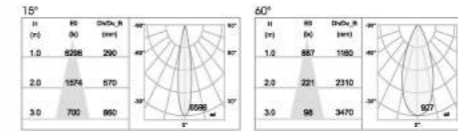

Intelligent Control

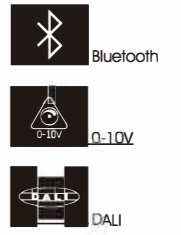

Track System

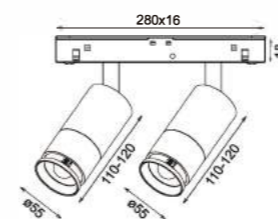
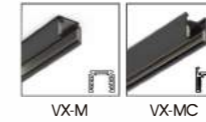

Reference Information

Model No.	System Power (W)	Beam Angle (°)	Luminous Flux (LM)	CCT (K)	CRI	Color
<b>VX-9130</b>	10W	15°-60°	800LM	2700/3000/3500/4000K	80/90/97	WH ● BL ● GR

Light Distribution

10W 3000K

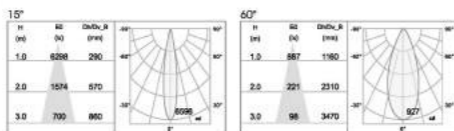

Intelligent Control

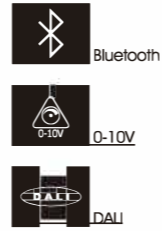

Track System

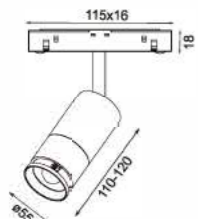
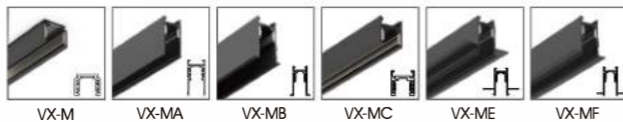

Reference Information

Model No.	System Power (W)	Beam Angle (°)	Luminous Flux (LM)	CCT (K)	CRI	Color
<b>VX-9130D</b>	2x10W	15°-60°	2x800LM	2700/3000/3500/4000K	80/90/97	WH ● BL ● GR

Light Distribution

10W 3000K

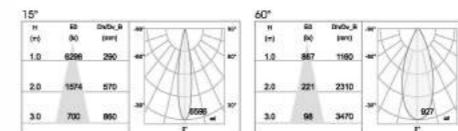

Intelligent Control

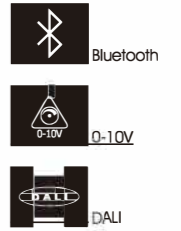

Track System

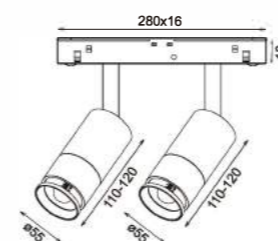
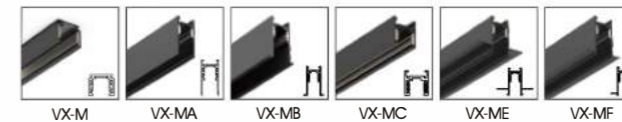



Reference Information

Model No.	System Power (W)	Beam Angle (°)	Luminous Flux (LM)	CCT (K)	CRI	Color
VX-8131	15W	15°-50°	1200LM	2700/3000/3500/4000K	80/90/97	WH ● BL ● GR

Light Distribution

15W 3000K

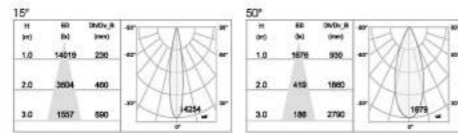

Intelligent Control

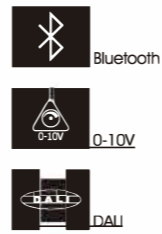

Track System

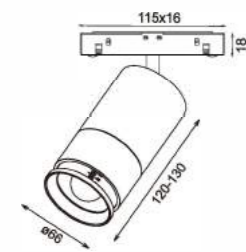
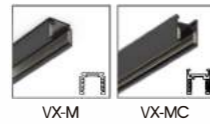

Reference Information

Model No.	System Power (W)	Beam Angle (°)	Luminous Flux (LM)	CCT (K)	CRI	Color
VX-8131D	2x15W	15°-50°	2x1200LM	2700/3000/3500/4000K	80/90/97	WH ● BL ● GR

Light Distribution

15W 3000K

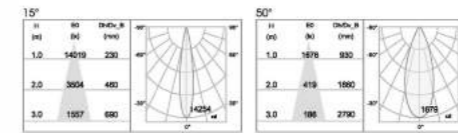

Intelligent Control

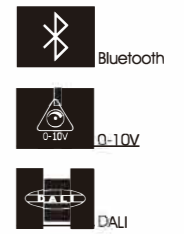

Track System

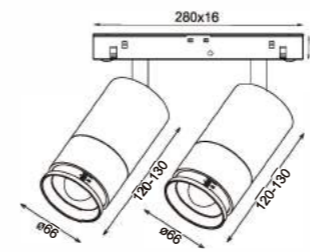
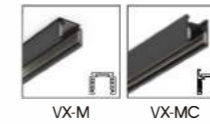

Reference Information

Model No.	System Power (W)	Beam Angle (°)	Luminous Flux (LM)	CCT (K)	CRI	Color
VX-9131	15W	15°-50°	1200LM	2700/3000/3500/4000K	80/90/97	WH ● BL ● GR

Light Distribution

15W 3000K

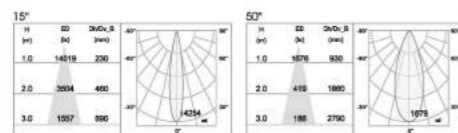

Intelligent Control

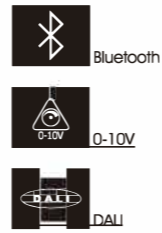

Track System

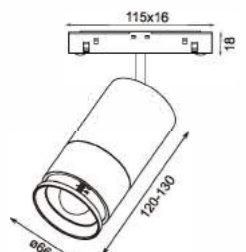
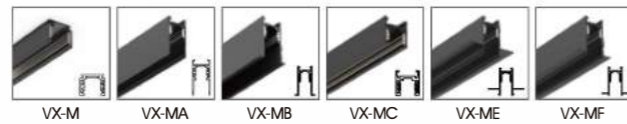

Reference Information

Model No.	System Power (W)	Beam Angle (°)	Luminous Flux (LM)	CCT (K)	CRI	Color
VX-9131D	2x15W	15°-50°	2x1200LM	2700/3000/3500/4000K	80/90/97	WH ● BL ● GR

Light Distribution

15W 3000K

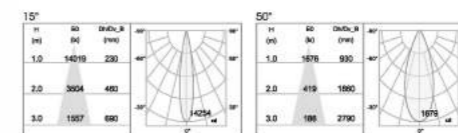

Intelligent Control

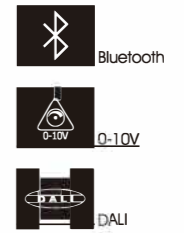

Track System

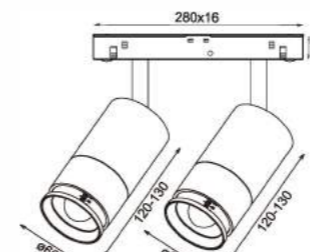
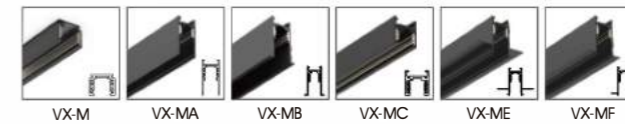

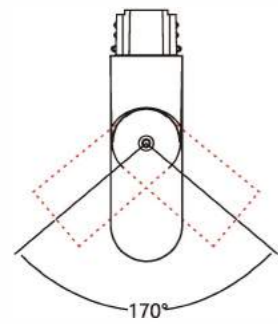
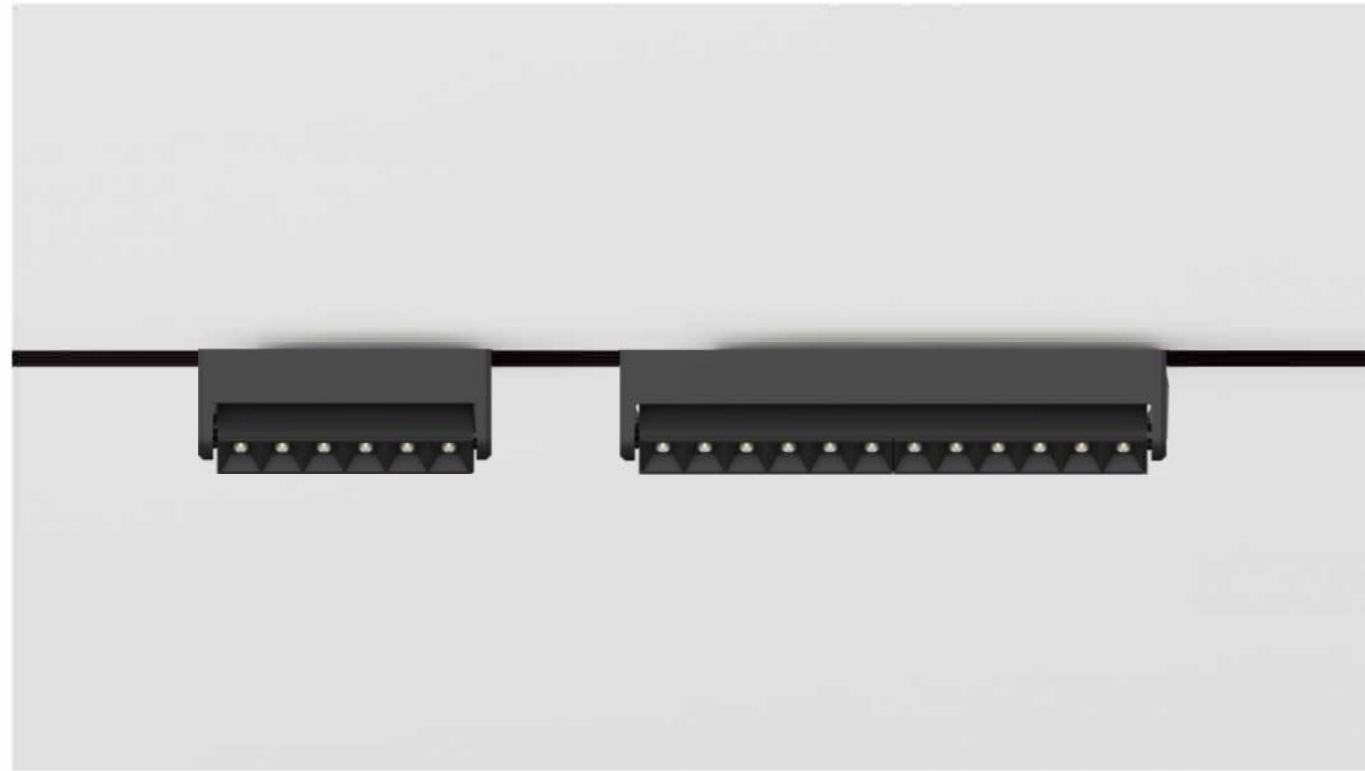

±85°可调节

## Linear Accent Light

Two specifications are available, 10W/20W. Deep anti-glare, classic shape. The lamp holder can swing, ±85° can be adjusted.

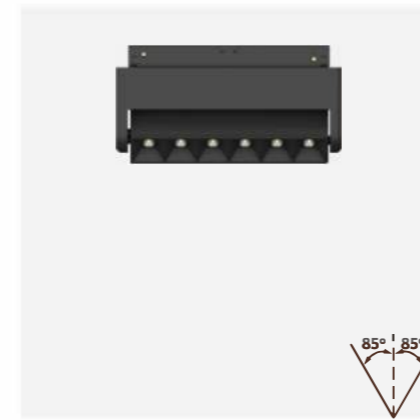

### Reference Information

Model No.	System Power (W)	Beam Angle (°)	Luminous Flux (LM)	CCT (K)	CRI	Color
<b>VX-8223</b>	6W 10W	15°/35°/45°	420LM 700LM	2700/3000/3500/4000K	80/90/97	WH BL GR

### Light Distribution

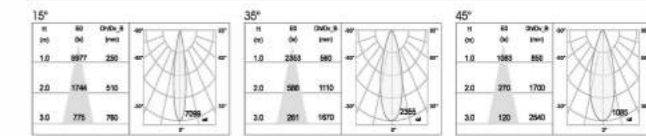

10W 3000K

Intelligent Control

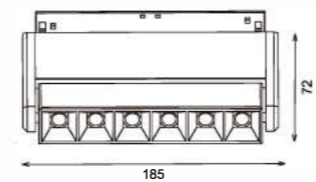
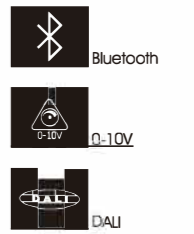

### Track System

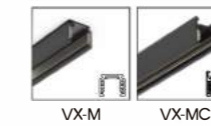

### Reference Information

Model No.	System Power (W)	Beam Angle (°)	Luminous Flux (LM)	CCT (K)	CRI	Color
<b>VX-9223</b>	6W 10W	15°/35°/45°	420LM 700LM	2700/3000/3500/4000K	80/90/97	WH BL GR

### Light Distribution

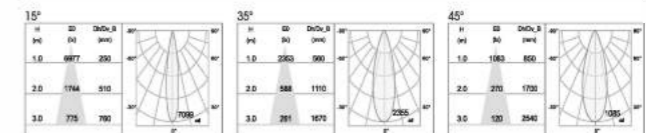

10W 3000K

Intelligent Control

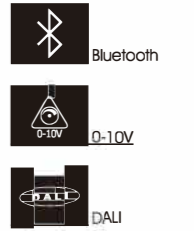

### Track System

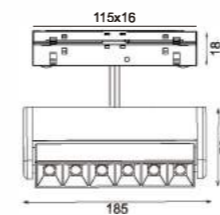
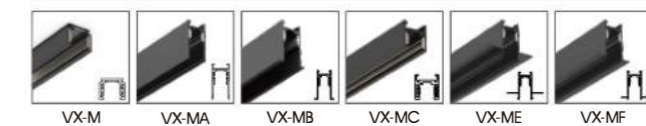



Reference Information

Model No.	System Power (W)	Beam Angle (°)	Luminous Flux (LM)	CCT (K)	CRI	Color
<b>VX-8224</b>	10W 20W	15°/35°/45°	700LM 1400LM	2700/3000/3500/4000K	80/90/97	WH ● BL ● GR

Light Distribution

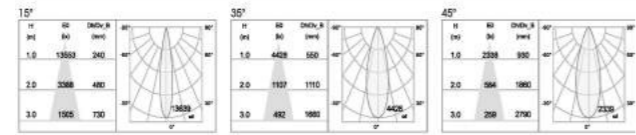

20W 3000K

Intelligent Control

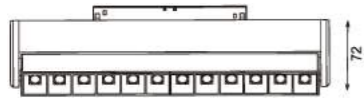
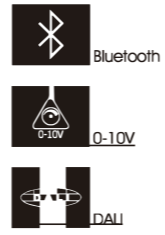

345

Track System

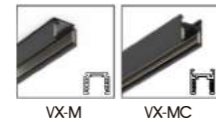

Reference Information

Model No.	System Power (W)	Beam Angle (°)	Luminous Flux (LM)	CCT (K)	CRI	Color
<b>VX-9224</b>	20W	15°/35°/45°	700LM/1400LM	2700/3000/3500/4000K	80/90/97	WH ● BL ● GR

Light Distribution

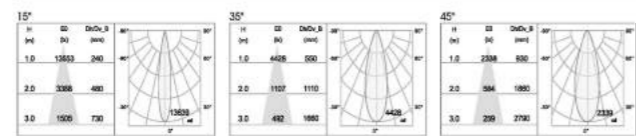

20W 3000K

Intelligent Control

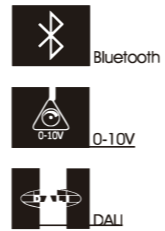

115x16

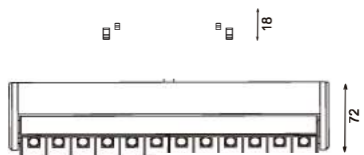

345

Track System

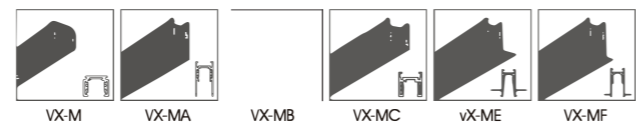

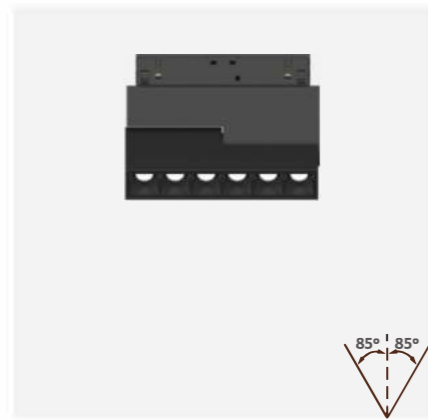

Reference Information

Model No.	System Power (W)	Beam Angle (°)	Luminous Flux (LM)	CCT (K)	CRI	Color
VX-9239	6W	15°/30°/45°	420LM	2700/3000/3500/4000K	80/90/97	WH BL GR

Light Distribution

6W 3000K

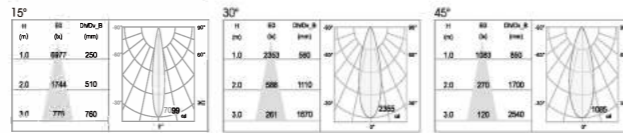

Intelligent Control

- Bluetooth
- 0-10V
- DALI

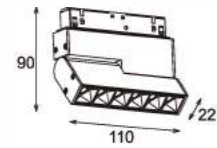

Track System

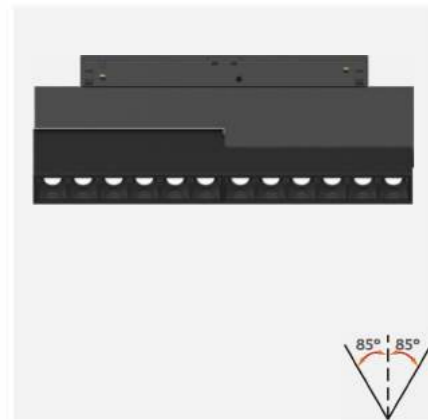
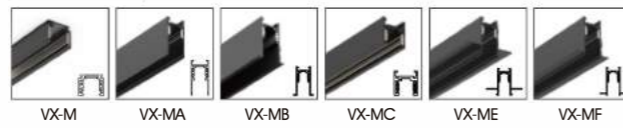

Reference Information

Model No.	System Power (W)	Beam Angle (°)	Luminous Flux (LM)	CCT (K)	CRI	Color
VX-9241	10W 15W	15°/30°/45°	700LM 1050LM	2700/3000/3500/4000K	80/90/97	WH BL GR

Light Distribution

15W 3000K

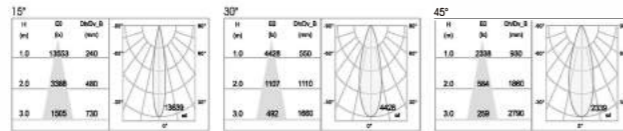

Intelligent Control

- Bluetooth
- 0-10V
- DALI

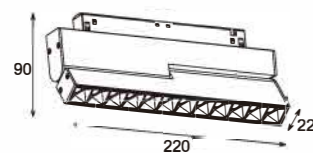

Track System

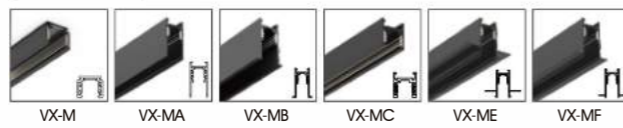

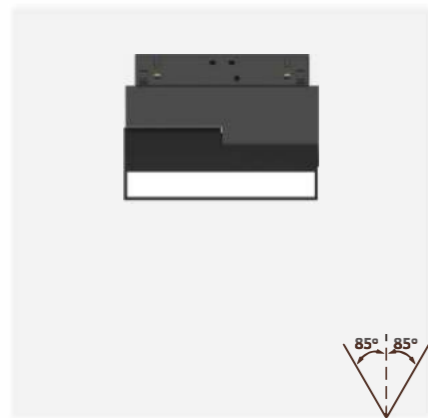

Reference Information

Model No.	System Power (W)	Beam Angle (°)	Luminous Flux (LM)	CCT (K)	CRI	Color
VX-9240	6W	90°	420LM	2700/3000/3500/4000K	80/90/97	WH BL GR

Light Distribution

6W 3000K

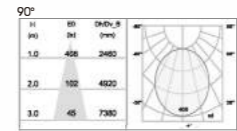

Intelligent Control

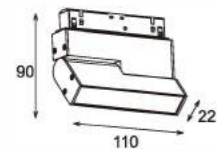

Track System

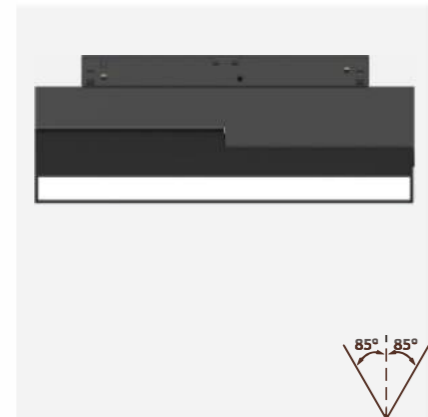
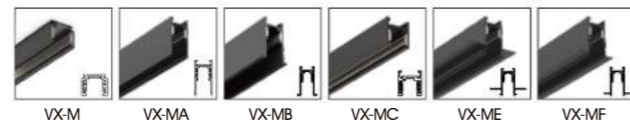

Reference Information

Model No.	System Power (W)	Beam Angle (°)	Luminous Flux (LM)	CCT (K)	CRI	Color
VX-9242	10W 15W	90°	700LM 1050LM	2700/3000/3500/4000K	80/90/97	WH BL GR

Light Distribution

15W 3000K

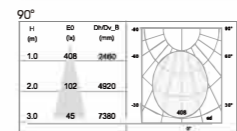

Intelligent Control

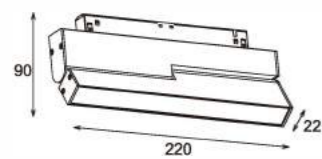

Track System

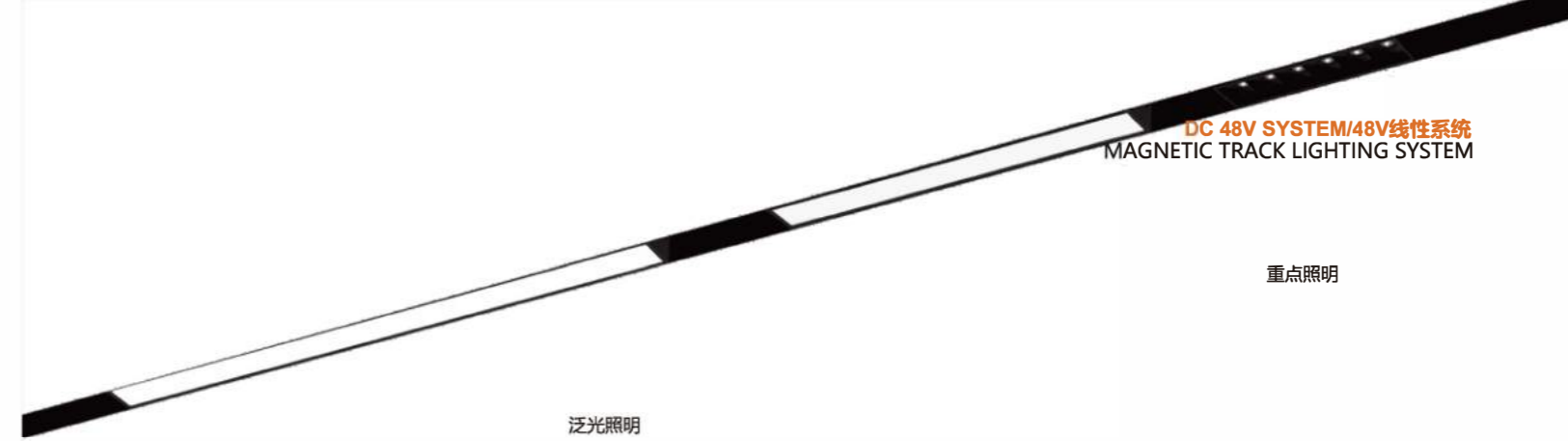
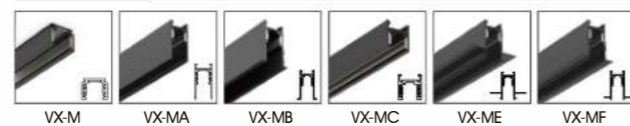

泛光照明

重点照明

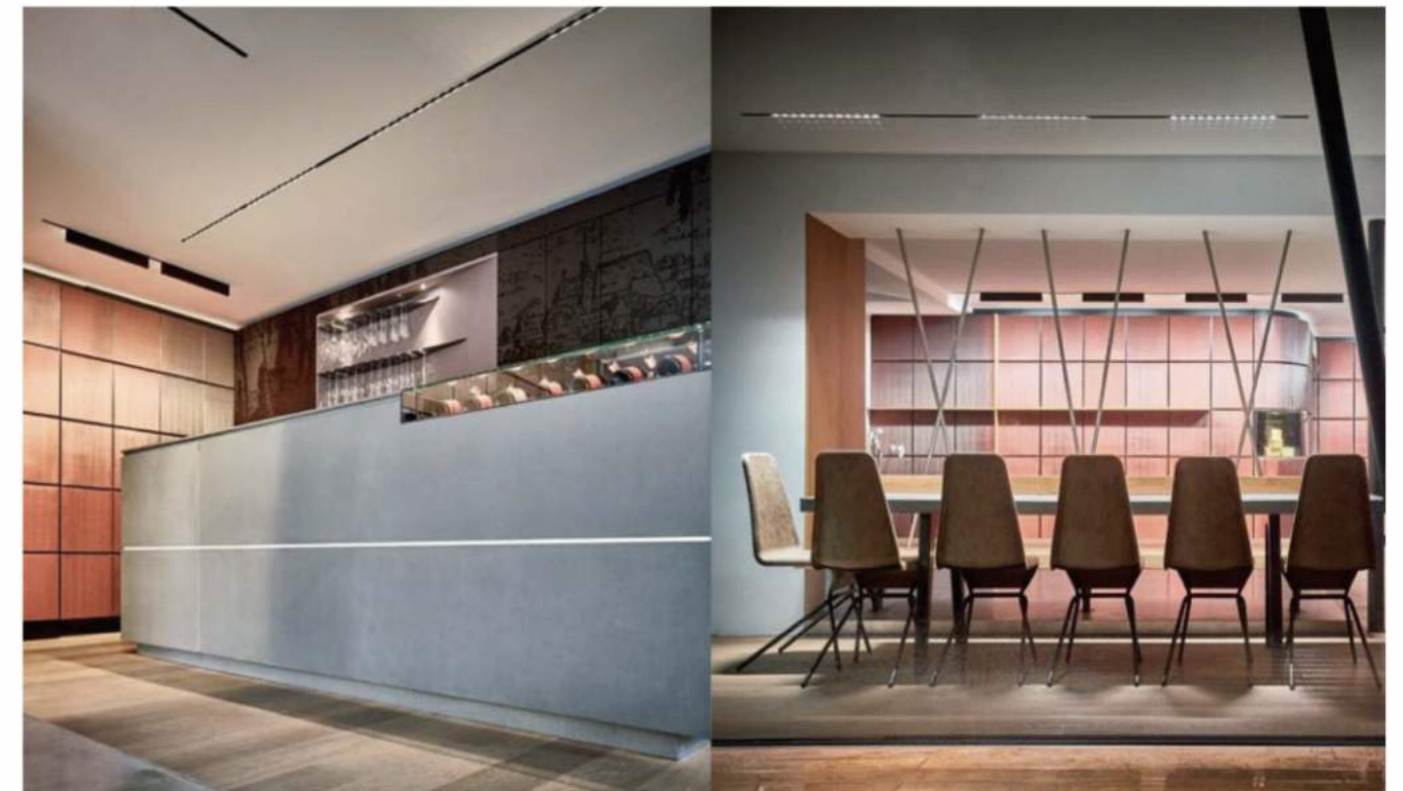

## Linear General Light 普通线性照明

Can be used in combination, seamless stitching  
Simple structure, easy installation, break the existing installation mode, can achieve seamless splicing, no dead angle, no dark area distribution of light scene.

结构简约，安装便利，打破现有安装模式，可实现无缝拼接，无死角，无暗区，分布光场景。



泛光照明



重点照明



Lock



## Linear Light

Power: 3W~30W

Length: 1000mm/1500mm/2000mm

- Simple structure, **convenient installation, break the existing installation mode**, can achieve seamless splicing, no dead corner, no dark area distribution of light scene.
- Multi-color temperature, **Bluetooth or WIFI monotonic light, Bluetooth or WIFI dimming and discoloration, multi-group**, scenario and other modes can be realized to reduce wiring and installation costs and achieve the purpose of intelligent light adjustment.
- 48V safety **ultra-low voltage, one-line special electrical equipment configuration**, clearly refers to more than 90/95, blue light hazard (<RG1), three years of quality assurance, mature stereotyping matching, safe and stable.







Reference Information

Model No.	System Power (W)	Beam Angle (°)	Luminous Flux (LM)	CCT (K)	CRI	Color
VX-9234	6W	15°/30°/45°	420LM	2700/3000/3500/4000K	80/90/97	WH BL GR

Light Distribution

6W 3000K

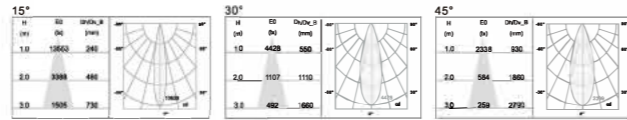

Intelligent Control

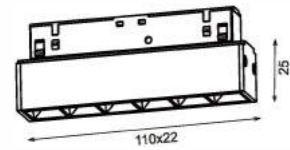
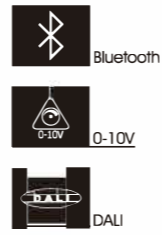

Track System

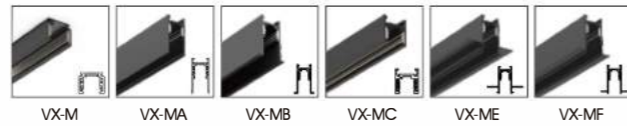

Reference Information

Model No.	System Power (W)	Beam Angle (°)	Luminous Flux (LM)	CCT (K)	CRI	Color
VX-9232	15W 20W	15°/30°/45°	1050LM 1400LM	2700/3000/3500/4000K	80/90/97	WH BL GR

Light Distribution

20W 3000K

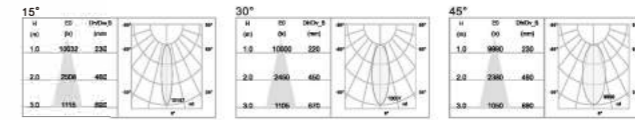

Intelligent Control

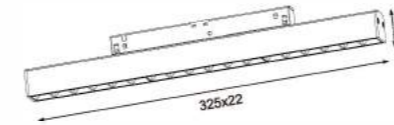
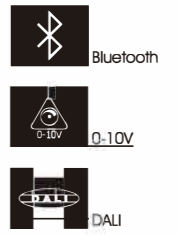

Track System

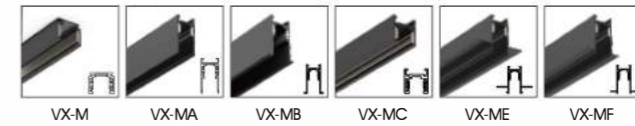

Reference Information

Model No.	System Power (W)	Beam Angle (°)	Luminous Flux (LM)	CCT (K)	CRI	Color
VX-9228	10W 15W	15°/30°/45°	700LM 1050LM	2700/3000/3500/4000K	80/90/97	WH BL GR

Light Distribution

15W 3000K

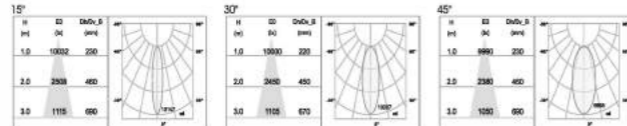

Intelligent Control

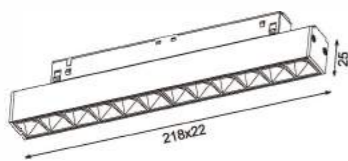
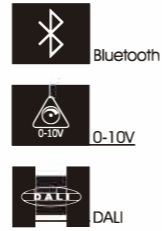

Track System

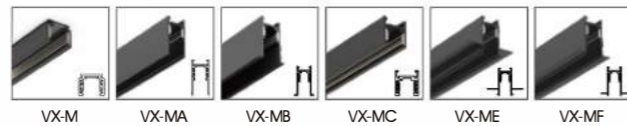

Reference Information

Model No.	System Power (W)	Beam Angle (°)	Luminous Flux (LM)	CCT (K)	CRI	Color
VX-9229	20W 28W	15°/30°/45°	1400LM 1960LM	2700/3000/3500/4000K	80/90/97	WH BL GR

Light Distribution

28W 3000K

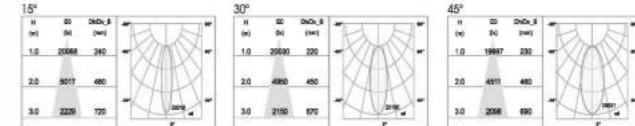

Intelligent Control

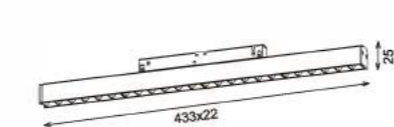
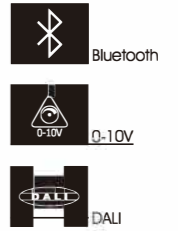

Track System

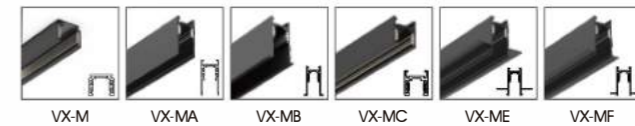



Reference Information

Model No.	System Power (W)	Beam Angle (°)	Luminous Flux (LM)	CCT (K)	CRI	Color
<b>VX-9235</b>	6W	90°	420LM	2700/3000/3500/4000K	80/90/97	WH BL GR

Light Distribution

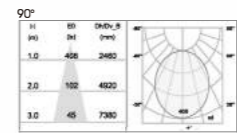

6W 3000K

Intelligent Control

- Bluetooth
- 0-10V
- DALI

Track System

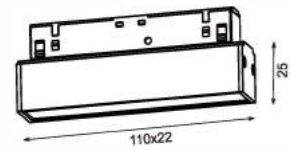
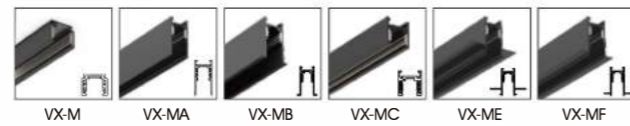

Reference Information

Model No.	System Power (W)	Beam Angle (°)	Luminous Flux (LM)	CCT (K)	CRI	Color
<b>VX-9233</b>	15W 20W	90°	1050LM 1400LM	2700/3000/3500/4000K	80/90/97	WH BL GR

Light Distribution

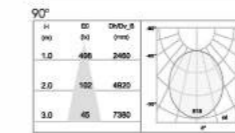

20W 3000K

Intelligent Control

- Bluetooth
- 0-10V
- DALI

Track System

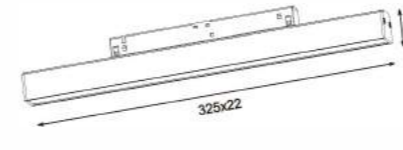
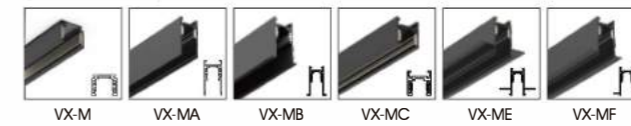

Reference Information

Model No.	System Power (W)	Beam Angle (°)	Luminous Flux (LM)	CCT (K)	CRI	Color
<b>VX-9230</b>	10W 15W	90°	700LM 1050LM	2700/3000/3500/4000K	80/90/97	WH BL GR

Light Distribution

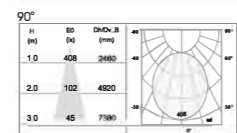

15W 3000K

Intelligent Control

- Bluetooth
- 0-10V
- DALI

Track System

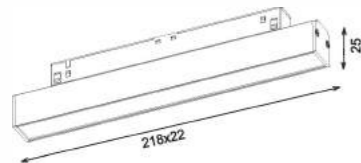
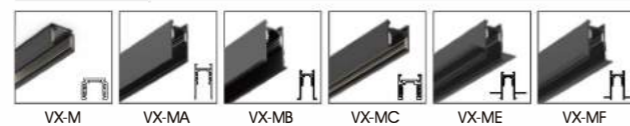

Reference Information

Model No.	System Power (W)	Beam Angle (°)	Luminous Flux (LM)	CCT (K)	CRI	Color
<b>VX-9231</b>	20W 28W	90°	1400LM 1960LM	2700/3000/3500/4000K	80/90/97	WH BL GR

Light Distribution

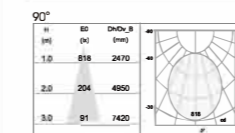

28W 3000K

Intelligent Control

- Bluetooth
- 0-10V
- DALI

Track System

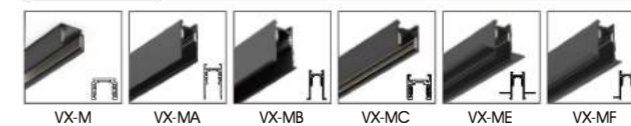



Reference Information

Model No.	System Power (W)	Beam Angle (°)	Luminous Flux (LM)	CCT (K)	CRI	Color
<b>VX-9236</b>	15W 20W	90°	1050LM 1400LM	2700/3000/3500/4000K	80/90/97	WH ● BL ● GR

Light Distribution

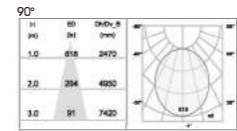

20W 3000K

Intelligent Control



Track System

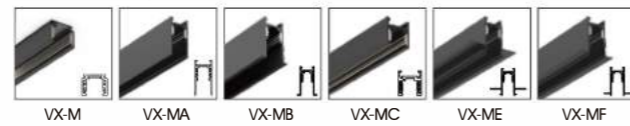

Reference Information

Model No.	System Power (W)	Beam Angle (°)	Luminous Flux (LM)	CCT (K)	CRI	Color
<b>VX-9238</b>	30W 40W	90°	2100LM 2800LM	2700/3000/3500/4000K	80/90/97	WH ● BL ● GR

Light Distribution

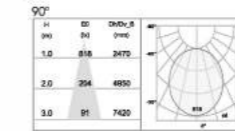

40W 3000K

Intelligent Control



Track System

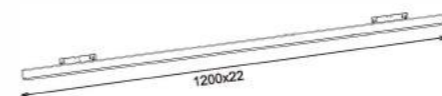
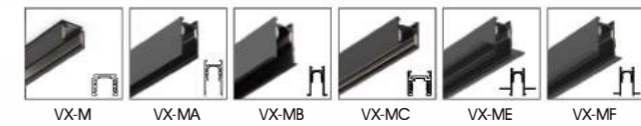

Reference Information

Model No.	System Power (W)	Beam Angle (°)	Luminous Flux (LM)	CCT (K)	CRI	Color
<b>VX-9237</b>	20W 30W	90°	1400LM 2100LM	2700/3000/3500/4000K	80/90/97	WH ● BL ● GR

Light Distribution

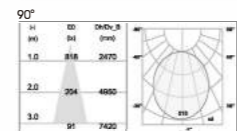

30W 3000K

Intelligent Control



Track System

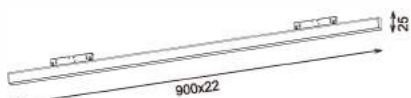
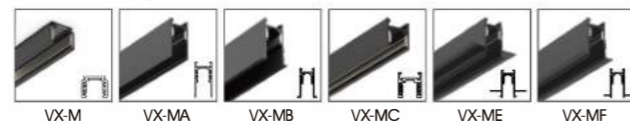



## Pendant Spotlight



重点照明/装饰照明/泛光照明;



### Reference Information

Model No.	System Power (W)	Beam Angle (°)	Luminous Flux (LM)	CCT (K)	CRI	Color
VX-9321	10W	20°/30°	800LM	2700/3000/3500/4000K	80/90/97	WH BL GR

### Light Distribution

10W 3000K

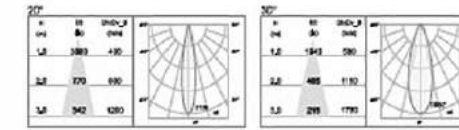

### Intelligent Control



### Track System

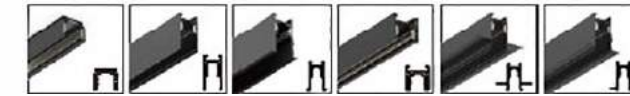

### Reference Information

Model No.	System Power (W)	Beam Angle (°)	Luminous Flux (LM)	CCT (K)	CRI	Color
VX-9322	10W	15°/24°/36°	800LM	2700/3000/3500/4000K	80/90/97	WH BL GR

### Light Distribution

10W 3000K

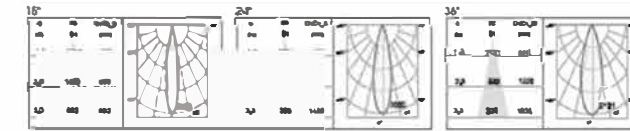

### Intelligent Control



### Track System





Reference Information

Model No.	System Power (W)	Beam Angle (°)	Luminous Flux (LM)	CCT (K)	CRI	Color
VX-9323	14W	20°/24°/36°	1120LM	2700/3000/3500/4000K	80/90/97	WH BL GR

Light Distribution

14W 3000K

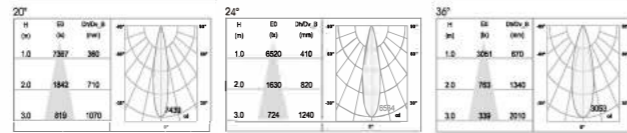

Intelligent Control

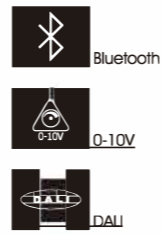

Track System

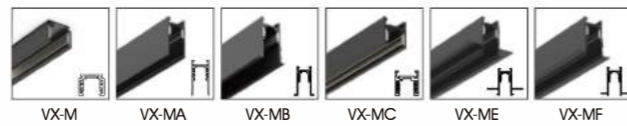

Reference Information

Model No.	System Power (W)	Beam Angle (°)	Luminous Flux (LM)	CCT (K)	CRI	Color
VX-9325	28W	20°/24°/36°	2240LM	2700/3000/3500/4000K	80/90/97	WH BL GR

Light Distribution

28W 3000K

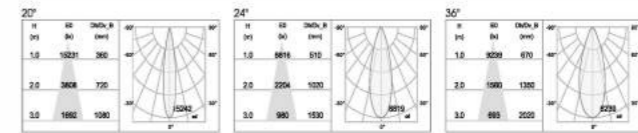

Intelligent Control

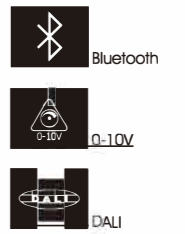

Track System

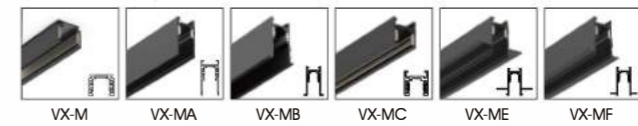

Reference Information

Model No.	System Power (W)	Beam Angle (°)	Luminous Flux (LM)	CCT (K)	CRI	Color
VX-9324	20W	15°/24°/36°	1600LM	2700/3000/3500/4000K	80/90/97	WH BL GR

Light Distribution

20W 3000K

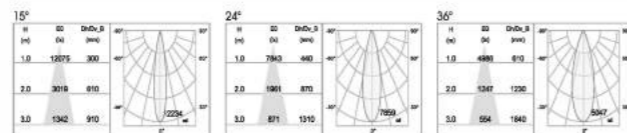

Intelligent Control

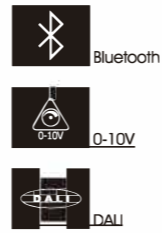

Track System

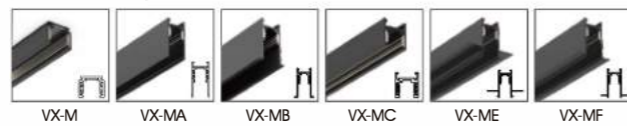

Reference Information

Model No.	System Power (W)	Beam Angle (°)	Luminous Flux (LM)	CCT (K)	CRI	Color
VX-9327	5W	15°/24°/36°	400LM	2700/3000/3500/4000K	80/90/97	WH BL GR

Light Distribution

5W 3000K

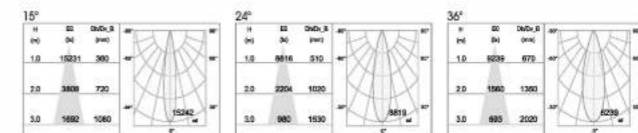

Intelligent Control

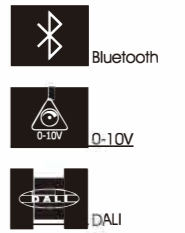

Track System

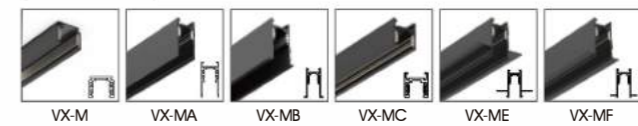



Reference Information

Model No.	System Power (W)	Beam Angle (°)	Luminous Flux (LM)	CCT (K)	CRI	Color
VX-9328	5W	15°/24°/36°	400LM	2700/3000/3500/4000K	80/90/97	WH ● BL ● GR

Light Distribution

5W 3000K

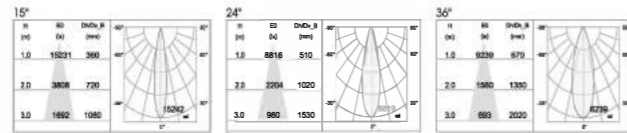

Intelligent Control

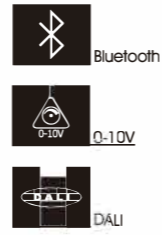

Track System

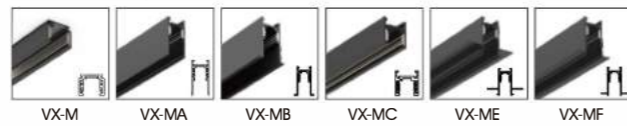

Reference Information

Model No.	System Power (W)	Beam Angle (°)	Luminous Flux (LM)	CCT (K)	CRI	Color
VX-9329	10W	10°-60°	800LM	2700/3000/3500/4000K	80/90/97	WH ● BL ● GR

Light Distribution

10W 3000K

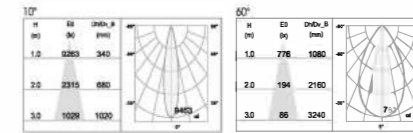

Intelligent Control

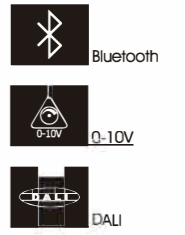

Track System

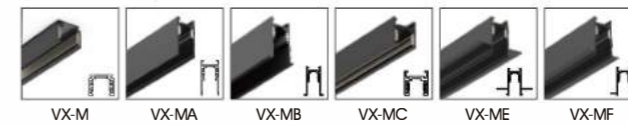

Reference Information

Model No.	System Power (W)	Beam Angle (°)	Luminous Flux (LM)	CCT (K)	CRI	Color
VX-9326	5W	180°	400LM	2700/3000/3500/4000K	80/90/97	WH ● BL ● GR

Light Distribution

5W 3000K

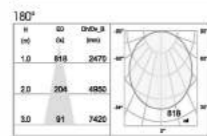

Intelligent Control



Track System

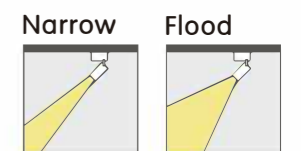
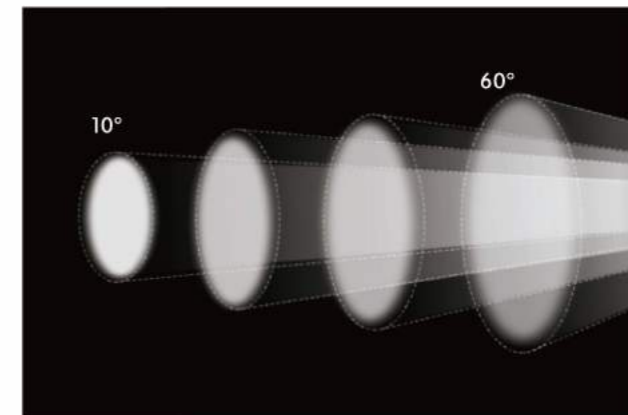
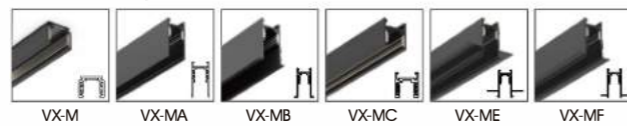

Non Dimming Wiring Diagrams 非调光接线示意图

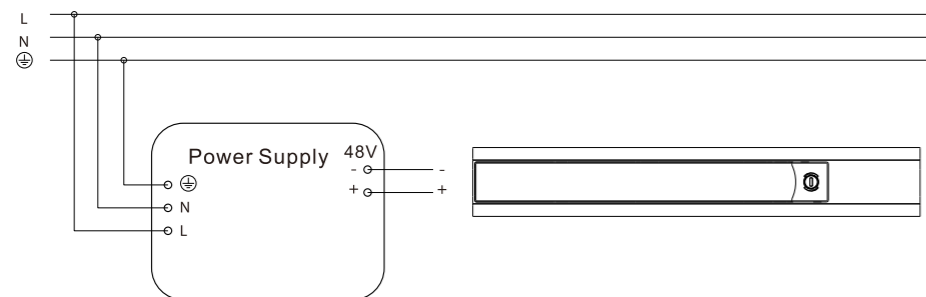

Dali Dimming Wiring Diagrams Dali 调接线示意图

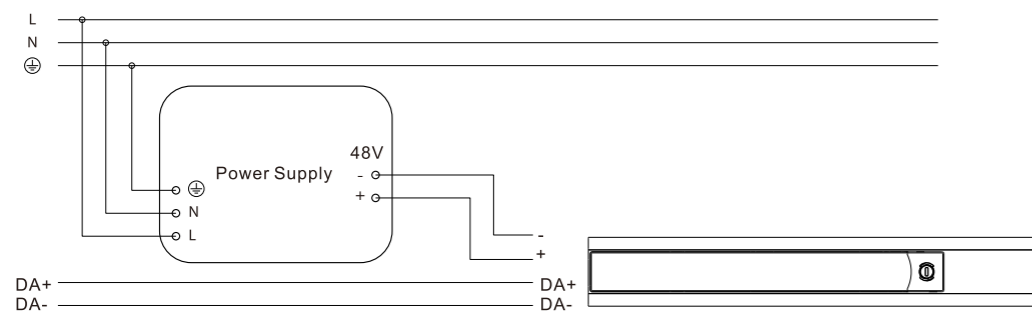

0/1-10V Dimming Wiring Diagrams 0/1-10V 调光接线示意图

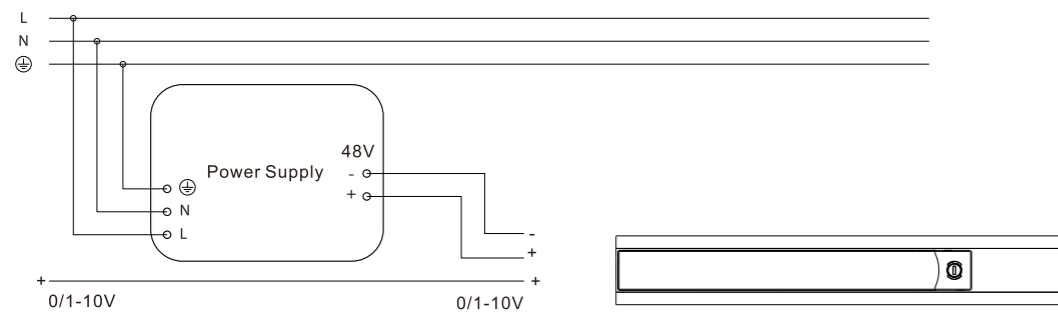



Address Head Office

18 harbour road, central plaza  
32/F 3208 office, wanchai, HK

Address Assembling Workshop

22 Kin Fat St. 11th Floor, Sun Hing Industrial Building,  
Tuen Mun, Hong Kong, China

NELUX group

[www.nelux.com.hk](http://www.nelux.com.hk)  
[www.solucionled.com](http://www.solucionled.com)

Contact Call +852 28600042

Email [salesnelux@gmail.com](mailto:salesnelux@gmail.com)