

Led strips and Profile  
Cintas led y perfiles  
Strisce e profili led

**KHUN** by nelux

KHUN Led strips by nelux



2023-2024 Catalogue

Nelux (HK) International, Ltd.,  
18 harbour road, central plaza, Offices 3208, 32/F  
Wanchai, Hong Kong , China

 852-28600042  
 852-28600066  
 sales@nelux.com.hk

Khun Led Strips

2023-2024

[www.nelux.com.hk](http://www.nelux.com.hk)

**12 Years** Specialized In Architectural Lighting



# LABORATORY FUNCTIONS & STANDARDS

## Material Testing:

- 1.Strain Relief Test,To test the PCB max.tensile force.
- 2.Twisting Test,To test the strip anti-twist ability,the strength of the LED bracketfold resistance and solder stability test of PCB.
- 3.Salt Spray Test.To test the product for corrosion resistance.Based onIEC68-2-11.
- 4.UV Accelerated Weathering Test.Simulated solar radiation.To test the material whether anti-UV.Test Standard: ASTM-G154

## Life Testing:

- 1.Working Temperature Test,Dot temperature control,to check the heat dissipation performance
- 2.Lumen Flux Maintenance Test.Lona time liahtina and aaina.to record the test data for lumen depreciation test.
- 3.Switching Test.Automatic uninterrupted switching(on/off).to test the ability to withstand the impact of transient currents.  
Guarantee the lifetime of products.which based on CIE:127/GB-T24824.

## Reliability Testing:

- 1.Thermal Shock Test. alternating heating and cooling.Instantaneously change-40c-150C. Get the test result which have chemical change or physical injury caused by expansion and contraction with heat in a short time.Based on IEC60068-2-14.
- 2.Power Temperature Cycle Test.-40C-65C.Continuous simulation of environment operation.by control the temperature and humidity:  
To test the product if can be used normally in constant temperature and humidity environment.Based on IEC 60068.
- 3.3M adhesive Tape Drop Test.To test the 3M tape viscosity,make sure the reliability of the 3M in using environment.
- 4.Drop Test.Simulation of dropping.Free fall that may be encountered during handling.test the ability to resist accidental impact.
- 5.Vibration Test. Simulatina the damaae caused by bumps in the car transportation. used to identify the ability of a product to withstand environmental vibrations.So improve the material and packaging quality.Test Standard:ISTA-1A

## WaterproofTesting:

Measure IP level,Different waterproof grade to 45 and 6.Based on EC60598.

## SOL Testing:

Dissolve the fluorescent alue. check the inside LED problem by microscope.

## OpticalTesting:

- 1.Integrating Sphere Test,Parameters such as Lumenpower and color temperature.CRI(Ra)etc.
- 2.IES/Goniophotometer Test,To get theIES data(Such as lumen, illumination, luminous efficiency, distribution curve flux,UGR index, etc.),meets the requirement CIE and IESNA standards.



# Quality Control



## IQC

- ◎ Conduct incoming materials quality control with reliable equipment.
- ◎ Conduct reliable tests.
- ◎ Prepare IQC Reports.

## IPQC

- ◎ Conduct first productio inspections in difierent stage
- ◎ ofproduction. Inspect the process of production.
- ◎ Conduct aging tests.
- ◎ Ensure the consistency and accuracy of products.
- ◎ Discover record and report quality exception.

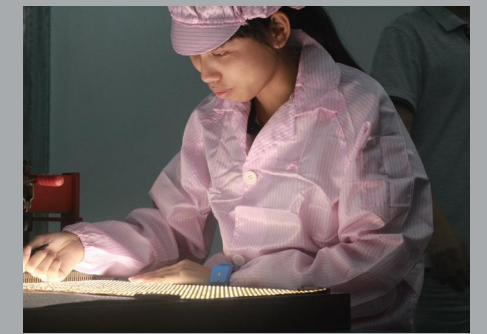

## OQC

- ◎ Conduct the finished product quality inspections according to inspection standards and procedures.
- ◎ Provide quality problem analysis and dispose of defective products.
- ◎ Test the final products and check theinstruments and eaiuiment.

## QE

- ◎ Verify and confirm the whole process of new productsnew raw materialsnew technologies and new modifications.
- ◎ Train the IQCIPQC.OQC before the massive production of new products.
- ◎ Discover and improve the production technology related to the inappropriate procedures.
- ◎ Handle the process exceptiontracking and improving.



## QM

- ◎ Provide quality management.
- ◎ Provide staff training.
- ◎ Manage the whole quality control system.



# WHY CHOOSE Nelux



01

## EFFICIENT&PROFESSIONALSERVICES

- Customized spee support label service.
- Customer first,12 hours response pollicy.
- Technical.Sales,Marketing team service.

02

## RELIABLE LED INDUSTRY EXPERIENCE

- 8 years speclazing in R&D,production and sales of high-qualty LED strins.
- Long-term supplier declaration to maintain friendly relations of cooperation.

03

## WIDE PRODUCT OPTIONS

- SMD3528 SMD5050.SMD7835 SMD2216 SMD3014.SMD5730 SMD2110.
- High GRLHigh efficiency Super thin Multi-color Constant current.
- IP20,1P54,IP65,IP67,IP68 options for indoor and outdoor application.

04

## STRONG PRODUCTION CAPACITY&FAST DELIVERYTIME

05

## OEM&ODM

- Different OEM&ODM services to help wholesaler or importers
- Wide color optians based on the ERP or ANSI CIEI standard
- Smaller CGT tolerance.
- One-Bin supplied.2-3-5 SDCM. High color consistency.
- Customized wattage per meter and lumen per meter Customized wire layout.

06

## STRICT QUALITY CONTROL

- 5 Steps for quality control.IOC,IPOc,Ooc,OF and OM.
- AllLFDs are LM-80 available nacking in Gulead Frame +99.99% Gold wire.
- Operations accredited toISO9001:2008.

07

## WORLDWIDE CERTIFICATES AS YOU NEED

08

## CORE VALUE CUSTOMER SUPPORT

- We are glad to update newest researches and product potation news as a priority.
- Best Price support,Maintain the absolute advantage of core value customer purchase price in Nelux system.
- Raw materials reserve stock in advance to shorten the lead time.

09

## COMFORTING AFTER-SALES

- Up to 3-5 years warranty,any problem of our product,we solve it within 7 days.
- Customer satisfaction investigation regularly ,to improv the custmomer experience.Relaxed and pleasant cooperation is our pursuit.

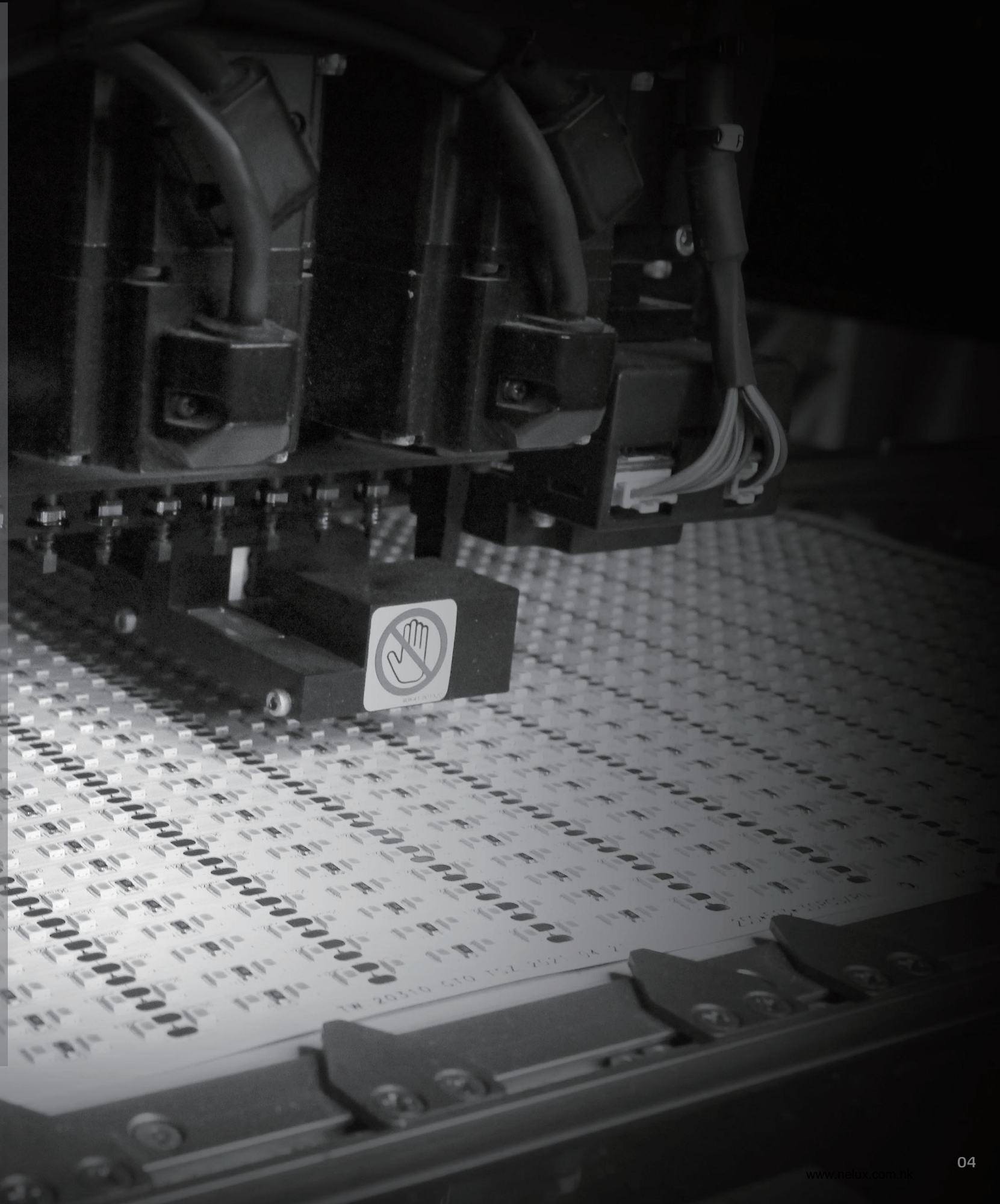



## Certification System

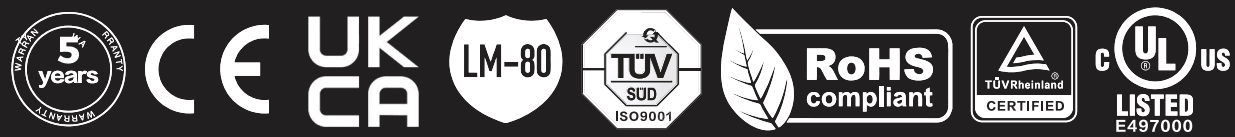





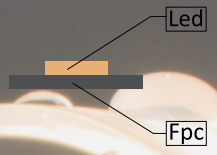
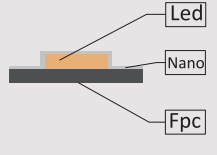
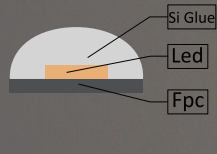
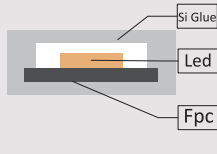
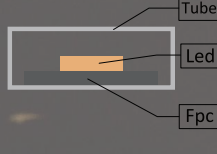
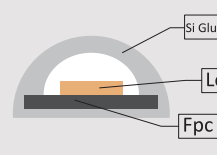
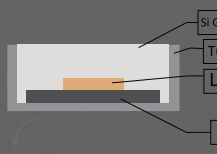
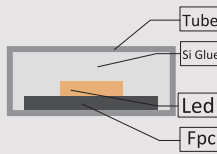
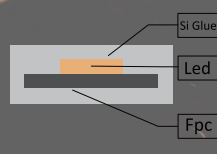















We work with more than 30 high speed automatic encapsulation pipelines and 15 automatic mounting and applied welding pipelines, characterizing complete LED strip production processes, such as LED encapsulation, high speed SMT, automatic welding, and full series of waterproof, with average monthly production capacity of 1.2 million meters. Set up new modern luminaries manufacturing factories so as to realize a whole chain of production processes including precision machining, automatic assembly, color spraying and free customization, with average monthly production capacity of 120,000, in order to deliver high-quality and cost-effective products to customers.

## Contrast of Process

IP RATING	STRUCTURE	FEATURE	REMARK
IP20		Non-Waterproof	Indoor Use Only
IP54		Nano Coated	Thin Film Coating Anti Splash Water Tiny Size Changed (Same Looking as IP20)
IP65		Silicone glue Coated Waterproof Suitable for Damp Location	Silicone Glue Coating Dropping Anti Splash Water Tiny Size Changed
IP67A		Silicone Extrusion Waterproof Suitable for Short-time Wet Location	Extruding Process Suitable for outdoor places without standing water
IP67B		Silicone Tube Waterproof Suitable for Damp Location	Silicone Empty inside Anti Spray Water Tiny Color Shift
IP67C		Silicone Extrusion Waterproof Suitable for Short-time Wet Location	Extruding Process Suitable for outdoor places without standing water
IP67D		U-Tube Instilled Silicone Glue Waterproof Suitable for Short-time Wet Location	Silicone Glue Coating Suitable for outdoor places without standing water
IP68A		Silicone Tube Injected Silicone Glue Waterproof Suitable for Outdoor and Underwater	360° Silicone Filling Use for Outdoor and Underwater
IP68B		Silicone Solid Extrusion Waterproof Suitable for Outdoor and Underwater	360° Silicone Filling Use for Outdoor and Underwater













# SMD STRIP PRODUCT LIST

Series	Product No.	Type	DC(V)	W/m	LEDs/m	LM/m (4000K)	CRI	PCBwidth (mm)	LEDs/cut (mm)	Length(m)	ERPEL	Warranty
High efficiency	1	 HE2835-24V-64D-08-20	24	4.8	64	854	>80 >90	8	8/125	5	C	5
	2	 HE2835-24V-80D-10-20	24	7.2	80	1287	>80 >90	10	8/100	5	C	5
	3	HE2835-24V-128D-10-20	24	9.6	128	1717	>80 >90	10	8/62.5	5	C	5
	4	HE2835-24V-160D-10-20	24	14.4	160	2581	>80 >90	10	8/50	5	C	5
	5	HE2835-24V-192D-10-20	24	18	192	3234	>80 >90	10	8/41.67	5	C	5
	6	HE2835-24V-240D-10-20	24	21.6	240	3840	>80 >90	10	8/33.33	5	C	5
	7	 HP2835-24V-90D-10-20	24	6	90	1246	>80 >90	10	9/100	5	B	5
	8	 HP2835-24V-180D-10-20	24	12	180	2650	>80 >90	10	9/50	5	B	5
	9	HP2835-24V-108D-10-20	24	7.2	108	1646	>80 >90	10	9/93.33	5	B	5
	10	HP2835-24V-162D-10-20	24	10.8	162	2157	>80 >90	10	9/55.55	5	B	5
	11	HP2835-24V-234D-10-20	24	15.6	234	2192	>80 >90	10	9/38.46	5	B	5
Ultra-long Series	12	 CC2835-24V-60D-10-20	24	2.88	60	314	>80	10	5/83.33	100	F	7
	13	 CC2835-24V-60D-10-20	24	5.76	60	593	>80	10	5/83.33	50	F	7
	14	CC2835-24V-120D-10-20	24	8.64	120	900	>80	10	5/42	40	F	7
	15	CC2835-24V-160D-10-20	24	7.5	160	713	>80	10	5/31.25	20	F	7
	16	 CC2835-48V-72D-12-20	48	6.5	72	767	>80	12	12/166.5	60	F	7
	17	 UL2835-48V-160D-8-20	48	14	160	2072	>80	8	16/100	40	D	7
	18	 CC5050RGBW-24V-60D-12-20	24	11	60	532	>80	12	5/83.33	30	/	5
	19	CC5050RGBW-24V-90D-12-20	24	18	90	787	>80	12	5/55.55	30	/	5
	20	 CC2835CA-24V-196D-12-20	24	11	196	1151	>90	12	14/71.42	20	E	5
	21	 CC2835HE-24V-192D-12-20	24	11	192	2145	>80	12	24/125	20	C	5
Super narrow Series	22	 UN2216-24V-144D-3-20	24	11.2	144	1265	>90	3	8/55.5	5	F	3
	23	UN2216-24V-288D-3-20	24	14	288	1244	>90	3	6/20.8	5	/	3
	24	 UN2110-24V-352D-4-20	24	9	352	990	>90	4	8/22.6	5	F	3
	25	 UN2835-24V-210D-5-20	24	10	210	1190	>80	5	7/33.5	5	E	3
	26	 UN5050-24V-108D-6-20-RGB	24	14	108	574	/	6	6/55.5	5	/	3
	27	 UN2022-24V-280D-3-20	24	8	280	967	>90	3	7/25	5	F	3
Mini cut Series	28	 MC2835-24V-120D-10-20	24	14	120	1610	>80	10	1/8.33	5	F	3
	29	 MC2835-12V-100D-10-20	12	15	100	2547	>80	10	2/20	5	D	3
	30	 MC2835-24V-200D-10-20	24	20	200	3220	>80	10	4/20	5	D	3
	31	 MC2835-24V-160D-5-20	24	10	160	1540	>80	5	2/12.5	5	D	3
	32	 MC2835CA-24V-224D-10-20	24	18	224	1926	>80	10	2/9	5	/	3



Series	Product No.	Type	DC(V)	W/m	LEDs/m	LM/m (4000K)	CRI	PCBwidth (mm)	LEDs/cut (mm)	Length(m)	ERPEL	Warranty
High density Series	33	HD2216-24V-300D-10-20	24	24	300	1800	>90	10	6/20.00	5	/	5
	34	HD2110-24V-700D-12-20	24	24	700	2136	>90	12	7/10.00	5	/	5
	35	HD2022-24V-320D-10-20	24	24	320	2640	>90	10	8/25.00	5	F	5
High brightness Series	36	HB5730-24V-160D-10-20	24	24	160	3312	>80	10	8/50	5	E	5
	37	HB2835-24V-480D-15-20	24	40	480	6160	>80	15	16/33.3	5	D	5
CCT Series	38	CA2835-24V-224D-12-20	24	21	224	2919	>80	12	16/71.5	5	E	5
	39	CA2216-24V-288D-10-20	24	22	288	2134	>90	10	16/55.5	5	/	5
	40	DTW2835-24V-168D-10-20	24	10	168	1064	>80	10	14/83.3	5	/	5
	41	DTW2216-24V-264D-10-20	24	18	264	1543	>90	10	12/45.5	5	/	5
	42	CA2022-24V-280D-10-20	24	22	280	2363	>90	10	14/50	5	F	5
Side-emitting Series	43	SE3014-24V-120D-8-20	24	9.6	120	1008	>80	8	6/50	5	F	5
S Shape Series	44	SHE2835-12V-64D-06-20	12	4.8	64	792	>80	6	4/62.5	5	D	5
	45	S2835-12V-60D-06-20	12	4.8	60	537	>80	6	3/50	5	F	5
	46	SRGB5050-12V-48D-08-20	12	7.2	48	266	/	8	3/62.2	5	F	3
	47	SHE2835-24V-128D-06-20	24	10	128	1590	>80	6	8/62.4	5	D	5
Lens Series	48	WW2835MC-24V-48D-20-67	24	14	48	1147	>90	20	1/11.3	5	F	1
	49	WW2835-24V-48D-20-67	24	18	48	2368	>80	20	8/166.6	5	F	1
	50	WW2835CA-24V-42D-20-67	24	16	42	1323	>90	20	7/166.6	5	F	1
	51	WW2835CC-24V-36D-20-67	24	12	36	1406	>80	20	6/166.6	5	F	1
	52	WW5050RGB-24V-42D-20-67	24	12	42	662	/	20	7/166.6	5	/	1
	53	WW5050RGBW-24V-42D-20-67	24	12	42	664	>80	20	7/166.6	5	F	1
	54	WW5050RGBDMX-24V-36D-20-67	24	12	36	520	/	20	6/166.6	5	/	1
RGB Series	55	RGB5050-24V-80D-10-20	24	10	80	487	/	10	8/100	5	/	3
	56	RGB3838-24V-160D-10-20	24	16	160	780	/	10	8/50	5	/	3
RGB+W Series	57	RGBW5050-24V-60D-12-20	24	16	60	816	>80	12	6/100	5	/	3
	58	RGBW5050-24V-112D-12-20	24	22	112	1276	>80	12	8/71.5	5	/	3
	59	RGB+W5050-24V-96D-12-20	24	22	96	1144	>80	12	8/83.33	5	/	3
	60	RGB+W5050/2835-24V-192D-12-20	24	24	192	1997	>80	12	16/83.33	5	/	3

Series	Product No.	Type	DC(V)	W/m	LEDs/m	LM/m (4000K)	CRI	PCBwidth (mm)	LEDs/cut (mm)	Length(m)	ERPEL	Warranty	
RGB+W+W Series	61	5 in 1 RGBW	RGBWW5050-24V-96D-12-20	24	30	96	1982	>80	12	6/62.5	5	/	3
	62	High Density	RGBWW5050-24V-112D-12-20	24	30	112	2560	>80	12	8/71.42	5	/	3
	63		RGB+W+W5050/2835-12V-72D-12-20	12	13	72	1073	>80	12	9/124.3	5	/	3
	64		RGB+W+W3838/2216-24V-336D-12-20	24	24	336	1968	>80	12	24/71.7	5	/	3
Digital Serie	65	5 v	SPI5050RGB-5V-60D-10-20	5	12	60	252	/	10	1/16.6	5	/	1
	66	5 mm	SPI2835-24V-120D-5-20	24	10	120	740	/	5	15/125	5	/	1
	67		SPI5050RGBID-12V-144D-12-20	12	20	144	500	/	12	1/6.94	5	/	1
	68		SPI5050RGBID-24V-60D-10-20	24	12	60	384	/	10	6/100	5	/	1
	69	SPI	SPI5050RGB-12V-60D-10-20	12	15	60	408	/	10	3/50	5	/	1
	70	512 DMX	DMX5050RGB-24V-60D-10-20	24	15	60	383	/	10	6/100	5	/	1
	71		SPI5050RGB-24V-84D-10-20	24	22	84	565	/	10	6/71.42	5	/	1
	72		DMX5050RGB-24V-84D-10-20	24	22	84	532	/	10	6/71.42	5	/	1
	73		DMX5050RGBW-24V-48D-12-20	24	12	48	511	/	12	13/250	5	/	1
	74		SPI5050RGBW-24V-60D-10-20	24	32	60	1092	/	10	6/100	5	/	1
	75		DMX5050RGBW-24V-60D-10-20	24	18	60	696	>80	10	6/100	5	/	1
	76	High Density	SPI5050RGBW-24V-84D-12-20	24	27	84	999	>80	12	6/71.42	5	/	1
COB Serie	77	Pass ERP	COB2016-24V-480D-8-20	24	10	480	980	>90	8	24/50	5	F	3
	78		COB2016-12V-512D-10-20	12	12	512	1212	>90	10	8/15.5	5	F	3
	79		COB2016-24V-546D-10-20	24	18	546	1404	>90	10	21/38.5	5	/	3
	80	5 mm	COB2016-24V-528D-5-20	24	9	528	828	>90	5	24/45	5	/	3
	81	3 mm	COB2016-12V-400D-3-20	12	4.8	400	456	>90	3	4/10	5	F	3
	82		COB2016CA-24V-640D-10-20	24	16	640	1168	>90	10	32/50	5	/	3
	83		COB2016RGB-24V-840D-10-20	24	15	840	615	/	10	21/25	5	/	3
	84	RGB RGBW	COB2016RGBW-24V-840D-12-20	24	18	840	504	/	12	21/33.3	5	/	3
	85	Side Emitting	COB2016SE-24V-480D-8-20	24	10	480	350	>90	8	16/33.3	5	/	3
	86	Box Dim	COBW2016-24V-512D-8-20	24	10	512	1134	>90	8	32/62.5	5	/	3
	87	Pro Series	COBW2016CA-24V-588D-12-20	24	14	588	908	>90	12	42/71.42	5	/	3
	88	High Density	COBW2016RGB-24V-1134D-12-20	24	15	1134	530	/	12	63/55.55	5	/	3
	89	67 IP	COB2016NEON-24V-480D-8-67	24	9	480	845	>90	8	24/50	5	/	3
	90	68 IP	COB2016NEON-24V-480D-8-68	24	9	480	618	>90	8	24/50	5	/	3
	91	CUT Anywhere	COB2016MC-12V-528D-8-20	12	10	528	899	>90	8	Anywhere Cuttable	5	/	3
	92	SPI RGB	COB2016SPIRGB-12V-630D-12-20	12	10	630	254	/	12	45/71.42	5	/	3

Series	Product No.	Type	DC(V)	W/m	LEDs/m	LM/m (4000K)	CRI	PCBwidth (mm)	LEDs/cut (mm)	Length(m)	ERPEL	Warranty
COB Series	93	 COB2016SPIRGB-24V-630D-12-20	24	13	630	375	/	12	63/100	5	/	3
	94	 COB2016CC-24V-504D-10-20	24	11	504	1120	>90	10	21/41.67	5	/	3
	95	 COBD2016-24V-80D-8-20	24	8	80	719	>90	8	8/100	5	/	3
	96	COBD2016-24V-160D-8-20	24	10	160	931	>90	8	8/50	5	/	3
	97	COBD2016-24V-240D-8-20	24	12	240	1170	>90	8	24/100	5	/	3
	98	COBD2016CA-24V-160D-10-20	24	20	160	1515	>90	10	16/100	5	/	3
	99	COBD2016RGB-24V-480D-10-20	24	15	480	597	/	10	8/50	5	/	3
Neon Flex Series	100	 D25P1-24V10-2835T-160D	24	20	160	2079	>80	10	8/50	5	/	3
	101	 D22P1-24V08-2835T-160D	24	20	160	1688	>80	8	8/50	5	/	3
	102	D18P1-24V06-2835T-160D	24	20	160	2311	>80	6	8/50	5	/	3
	103	D16P1-24V05-2835T-210D	24	20	210	1964	>80	5	7/33.3	5	/	3
	104	 3D1616-24V06-2835T-160D	24	8	160	625	>80 >90	6	8/50	5	/	3
	105	 1225-24V10-2835S-120D-IP68	24	10	120	450	>80 >90	10	6/50	5	/	3
	106	1616-24V10-2835T-120D-IP68	24	10	120	563	>80 >90	10	6/50	5	/	3
	107	 0410-24V06-2835S-160D	24	8	160	426	>80 >90	6	8/50	5	/	3
	108	0613-24V08-2835S-120D	24	10	120	433	>80 >90	8	6/50	5	/	3
	109	1022-24V10-2835S-120D	24	10	120	399	>80 >90	10	6/50	5	/	3
	110	1715-24V10-2835T-120D	24	10	120	853	>80 >90	10	6/50	5	/	3
111	 1010-24V08-2835T-140D	24	10	140	780	>80 >90	8	7/50	5	/	3	
Panel Flex	112	PL2835-24V-288D-20	24	30	288	3219	>90	240*480	1/20*20	1	/	3
	113	PL6060-24V-288D-20	24	35	288	3365	>80	240*480	1/20*20	1	/	3
	114	 PL2835TW-24V-576D-20	24	36	576	2895	>90	240*480	2/20*20	1	/	3
	115	 PL5050RGB-24V-288D-20	24	55	288	1543	/	240*480	12/40*120	1	/	3
	116	PL5050RGBW-24V-288D-20	24	60	288	3559	>80	240*480	12/40*120	1	/	3
	117	 PL5050RGBWW-24V-288D-20	24	70	288	3994	>80	240*480	12/40*120	1	/	3
	118	 PL5050SPIRGB-24V-288D-20	24	75	288	1751	/	240*480	12/20*240	1	/	3



# BINNING

## ISO-TEMPERATURE LINES OF KHUN by nelux

Base on international ANSI standard, Nelux divides every CCT into 2 or 3 bins, make sure customers to get the same color even for each order.

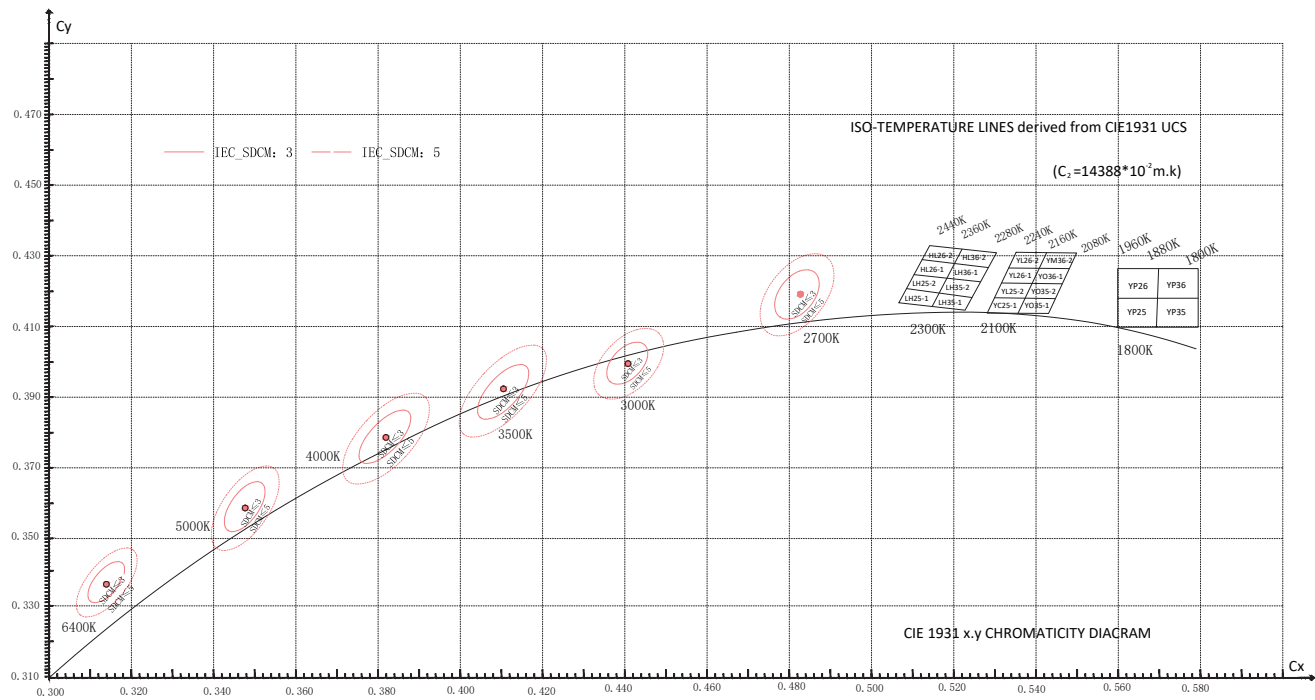

## Customize any color as you want

Offer your idea of any color, wavelength, CCT, and BIN coordinate of LED for your order.



2-step Mcadam



3-step Mcadam



5-step Mcadam



7-step Mcadam

FS CRI > 98, as natural as sunshine

The color rendition is as natural as sunshine with the CRI ≥ 95 or full spectrum LEDs.

# CRI

## (COLOR RENDERING INDEX)



COMPACT FLUORESCENT  
**50 CRI**

STANDARD LED  
**80 CRI**

LUX HIGH CRI  
**90+ CRI**

## COLOR RENDERING PERFORMANCE

### Q What is CRI R9 and Why is it Important?

A CRI R9 is one of the test color samples (TCS) used in the calculation of extended CRI. Many manufacturers will only report general CRI, however, which does not include the CRI R9 score.

CRI R9 is therefore oftentimes a useful supplemental score to judge a light source's color rendering ability, specifically as it concerns objects whose reflectance spectra contain red wavelengths.

### Q What is CRI R9?

A R9 is the score that represents how accurately a light source will reproduce strong red colors.

"Accurate" is defined as similarity to daylight or incandescent bulbs, depending on the color temperature.

Just like each of the CRI R value calculations, R9 is calculated by calculating the reflected color from a theoretical object with the reflectance profile defined as TCS9. The reflectance spectra is provided below:

What is notable is that the TCS9 spectrum is almost entirely composed of red light. Spectrum-wise, we see this as wavelengths longer than 600 nm. This means that if there is not enough red light in the light source, it will make red colors appear "off" or different.

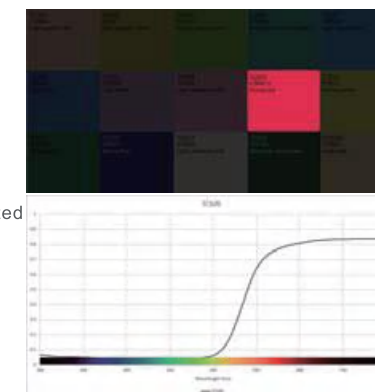

### Q Why is CRI R9 important?

A CRI R9 is a very important metric because many light sources will be lacking in red content, but this fact will be hidden due to the averaging out of CRI calculations which do not include R9.

As the chart below shows, an light source can actually perform quite well with the first 8 test color samples, scoring quite well for R1-R8. For the general CRI Ra metric, this means that an LED with poor red color rendering can still get by with an 80 CRI (Ra) rating.

A closer look at the R9 value, however, reveals that the light will perform very poorly for red colors in particular.

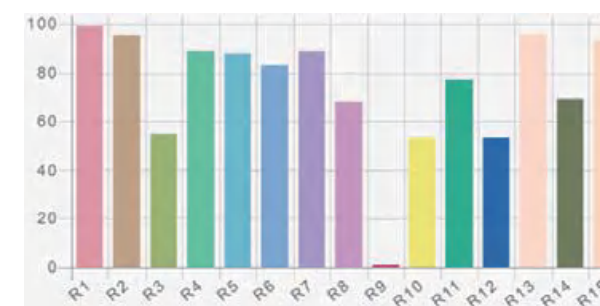

### Q What is a good CRI R9 value?

A Although the maximum possible value of R9 is also 100, unlike average CRI numbers, R9 should be judged a bit differently.

Mathematically, R9 is far more difficult to achieve a high score compared to the other R values that comprise the CRI calculations, and is far more sensitive to spectral variations. Therefore, an R9 score of 50 or above would be considered "good" while an R9 score of 90 or above would be considered "excellent."

You will therefore find that most lighting products available in the market will rarely specify the R9 value, and when they do, rarely will they guarantee anything higher than 50.

This is due to the fact that CRI utilizes the CIE 1960 uv color space, which is skewed in a way that exaggerates color differences in the red region of the chromatic diagram. Since CRI is a calculation that quantifies color differences between a light source and a reference source, a larger calculated color difference will result in a larger decrease in the R score.

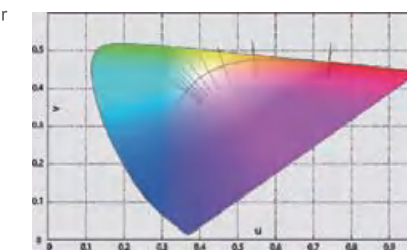

### Q Why is red such an important color?

A Red is a crucial color for many applications including photography, textiles and reproduction of human skin tones. When searching for a high color quality LED, be sure to inquire about the CRI as well as its R9 value.



# COLOR APPLICATION GUIDELINES

Different color temperatures for different environments make it possible to choose appropriate light source as required.

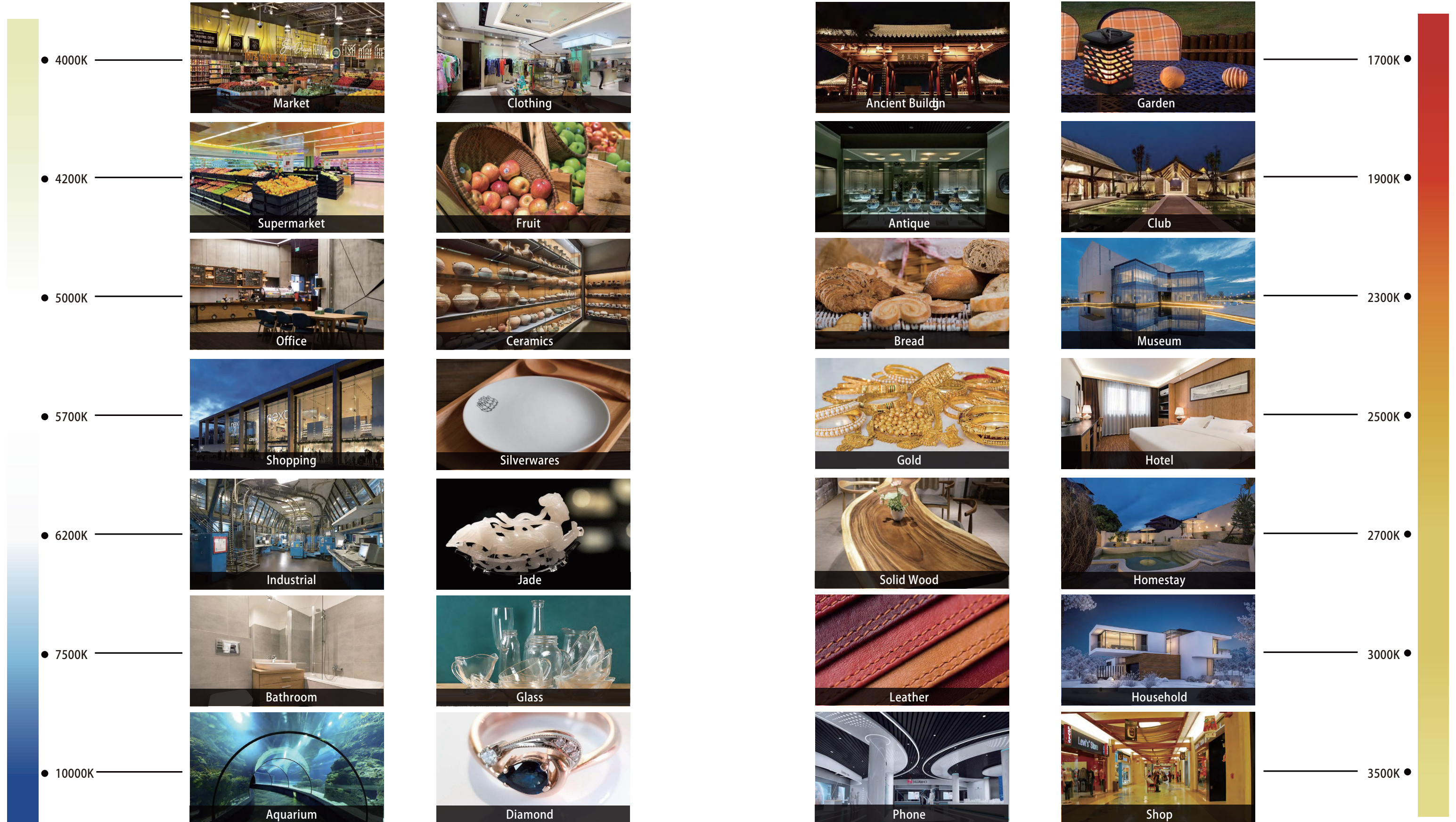



# LED STRIP SOLUTION

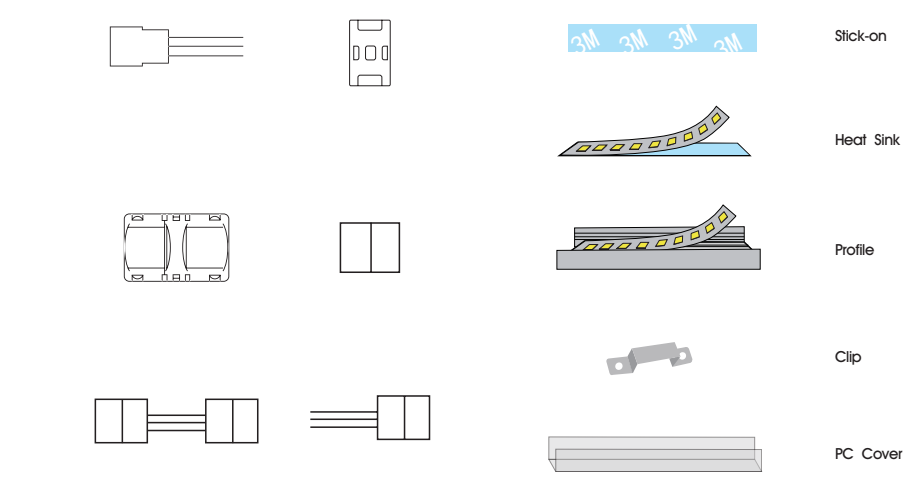
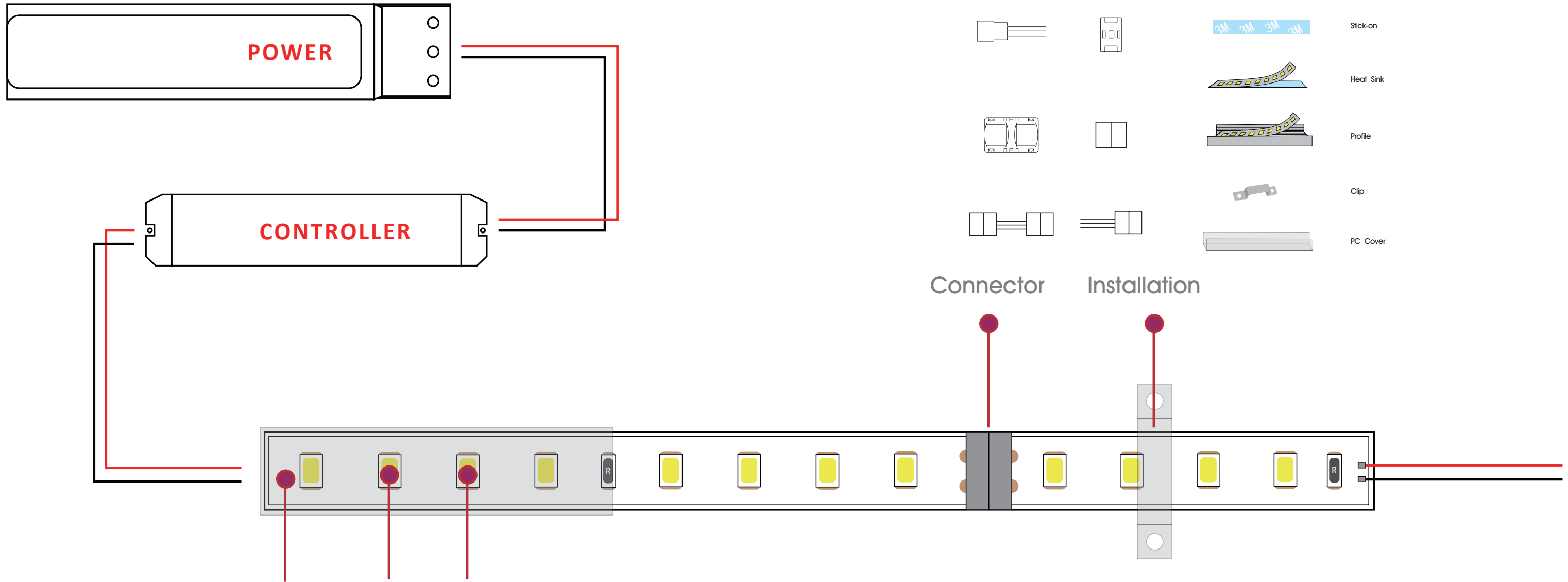

Connector Installation

## IP Process



More optional series and types

## LED LED STRIP



Various options, optional ordering, Customizable CCT & BIN

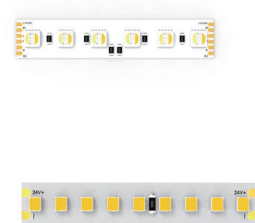

More optional series and types customize LED strip as you need

## Cables

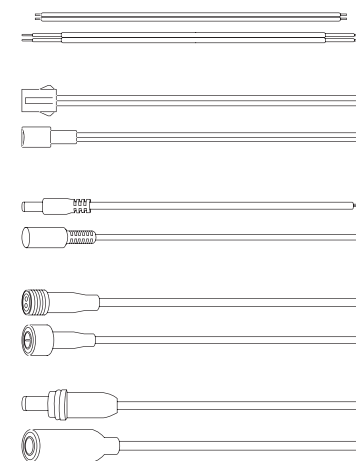

## Package

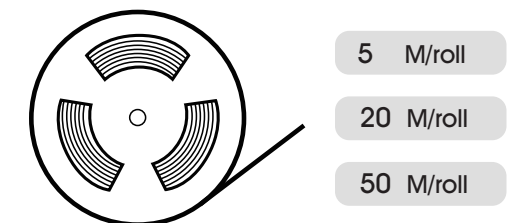

## COOPERATION PARTNERS

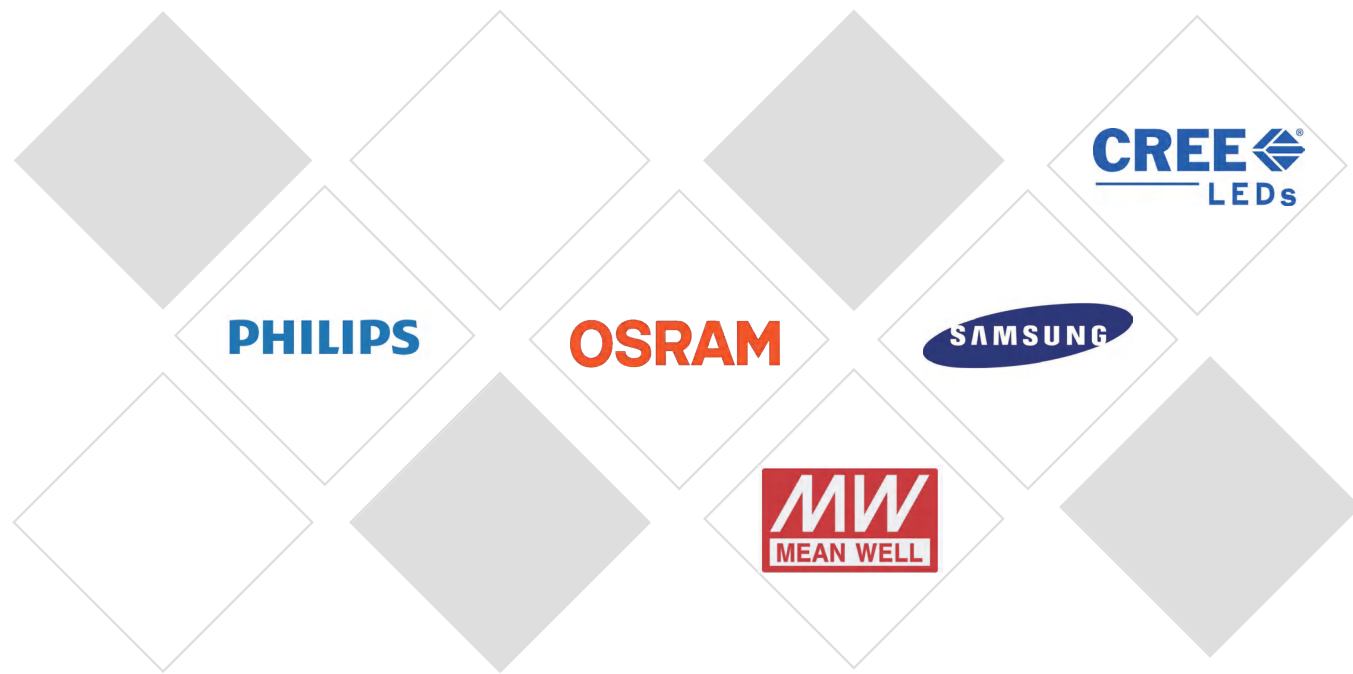

## ORDER PROCESS

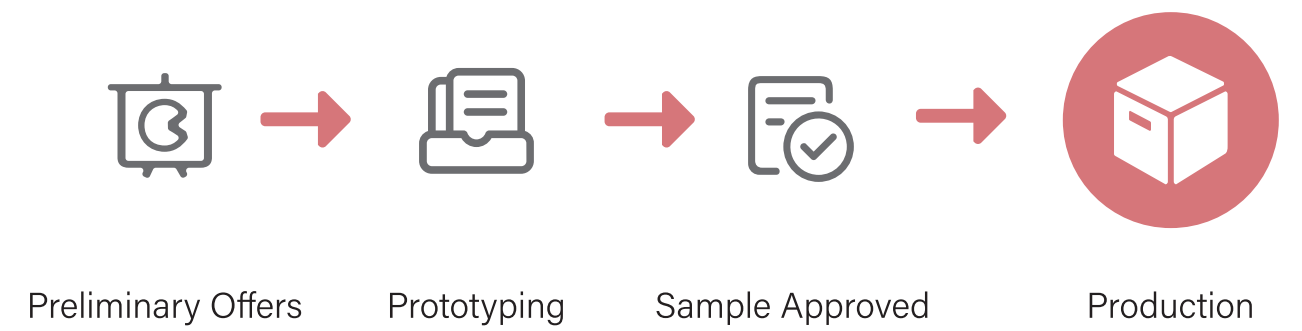
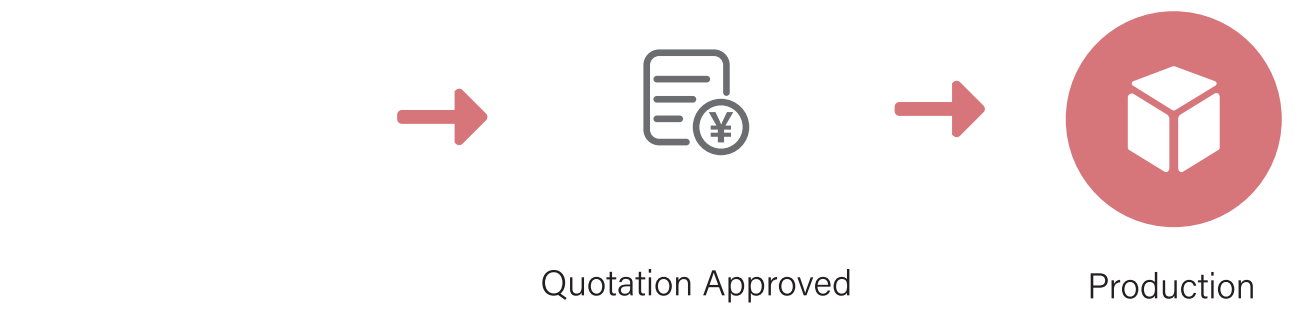
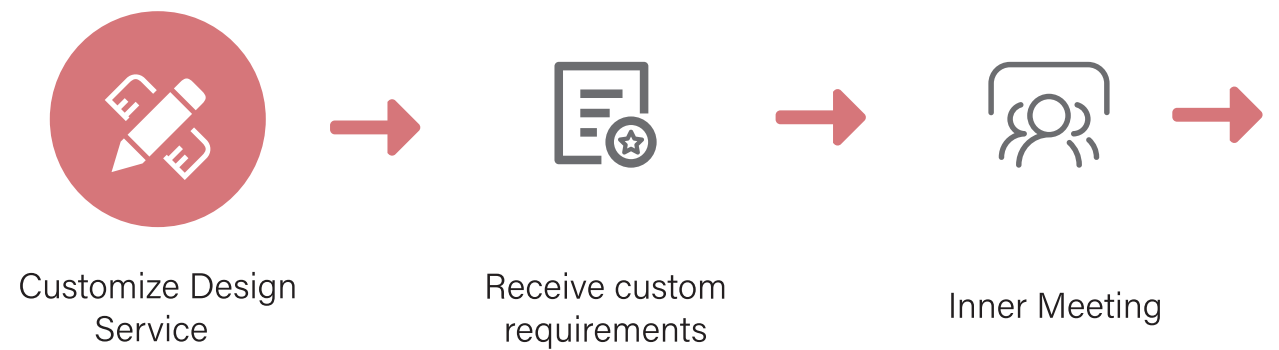
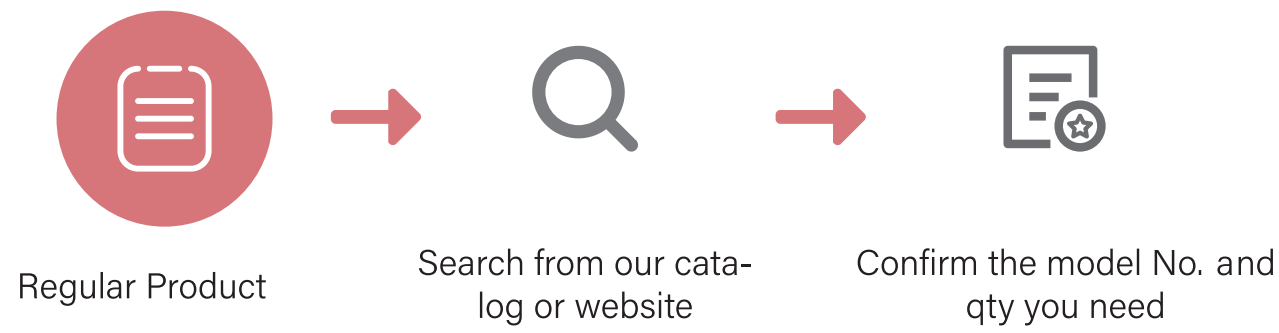

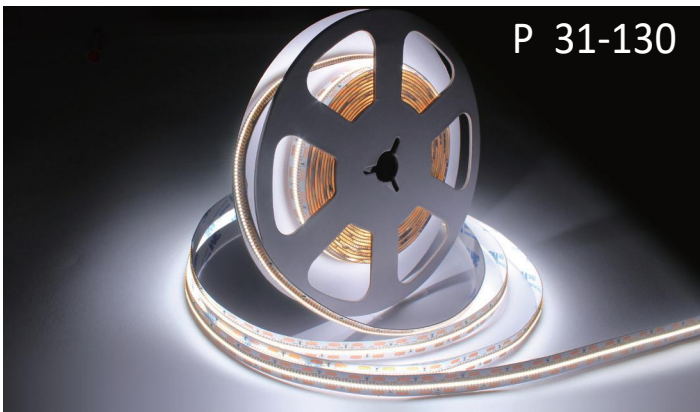

P 31-130

Conventional light strip



P 131-154

COB series

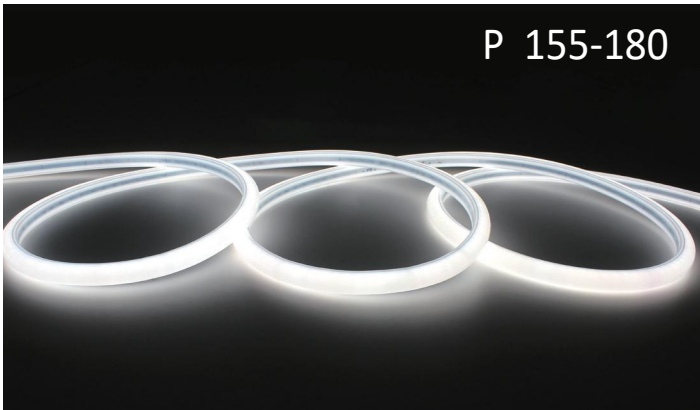

P 155-180

Neon flex series

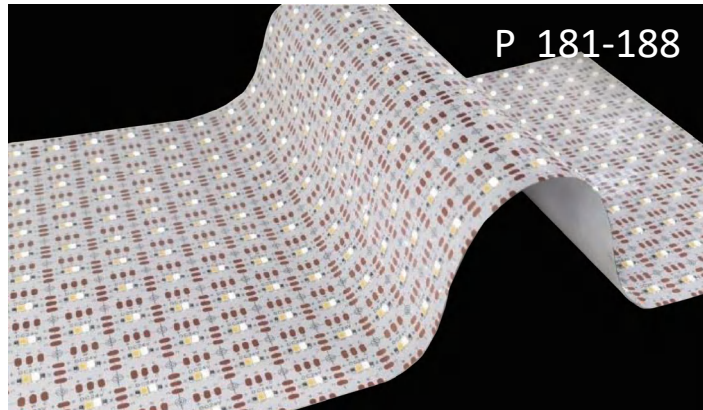

P 181-188

Panel flex



P 189-206

Profile



P 207-228

Accessories

## CONTENTS

High efficiency series	31
Ultra-long series	45
Super narrow series	56
Mini cuttable series	65
High density series	71
High brightness series	75
CCT series	78
Side-emitting series	85
S shape series	87
Lens series	93
Multi-color series	103
Digital series	115
COB series	131
Neon flex series	155
Panel flex	181
Profile	189
Accessories	207



01 High efficiency series Pass ERP 150lm/W; 180lm/W; 200lm/W; 220lm/W



02 Ultra-long series 100m/roll without color difference



03 Super narrow series Super narrow only 3mm width



04 Mini cut series Cuttable only 8.33mm

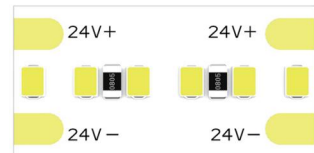

05 High density series Super density up to 700leds/m

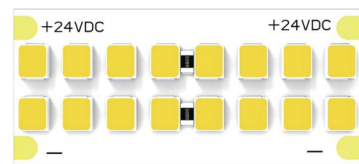

06 High brightness series Lumen higher than 6000lm/m



07 CCT series Wide CCT range from 1800K~10000K  
Khun Led Strips



Wider beam angle Side-emitting series 08



up to 90° bendable S shape series 09



15°/15°-20°/20°/30°/60°/15°\*45° RGB & RGBW available Lens series 10



RGB/RGBW/RGBWW optional Multi-color series 11



WS2812B/WS2813B/WS2815B/DMX 512 available Digital series 12



Great linear effect; W/RGB/TW optional Cob series 13

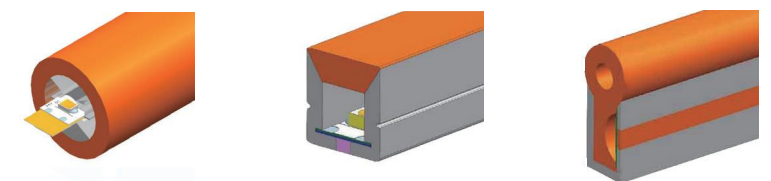

IP67/IP68/3D Neon Flex optional Neon flex series 14



# Khun High efficiency Series

New ECO Design Regulation (EU) 2019/2020  
High Efficiency LED Strips

Light efficiency up to 150LM/W, 180LM/W & 200LM/W, New energy label up to Class B.  
CRI80+, 90+, 95+ optional.  
Operate longer life and better for energy saving.

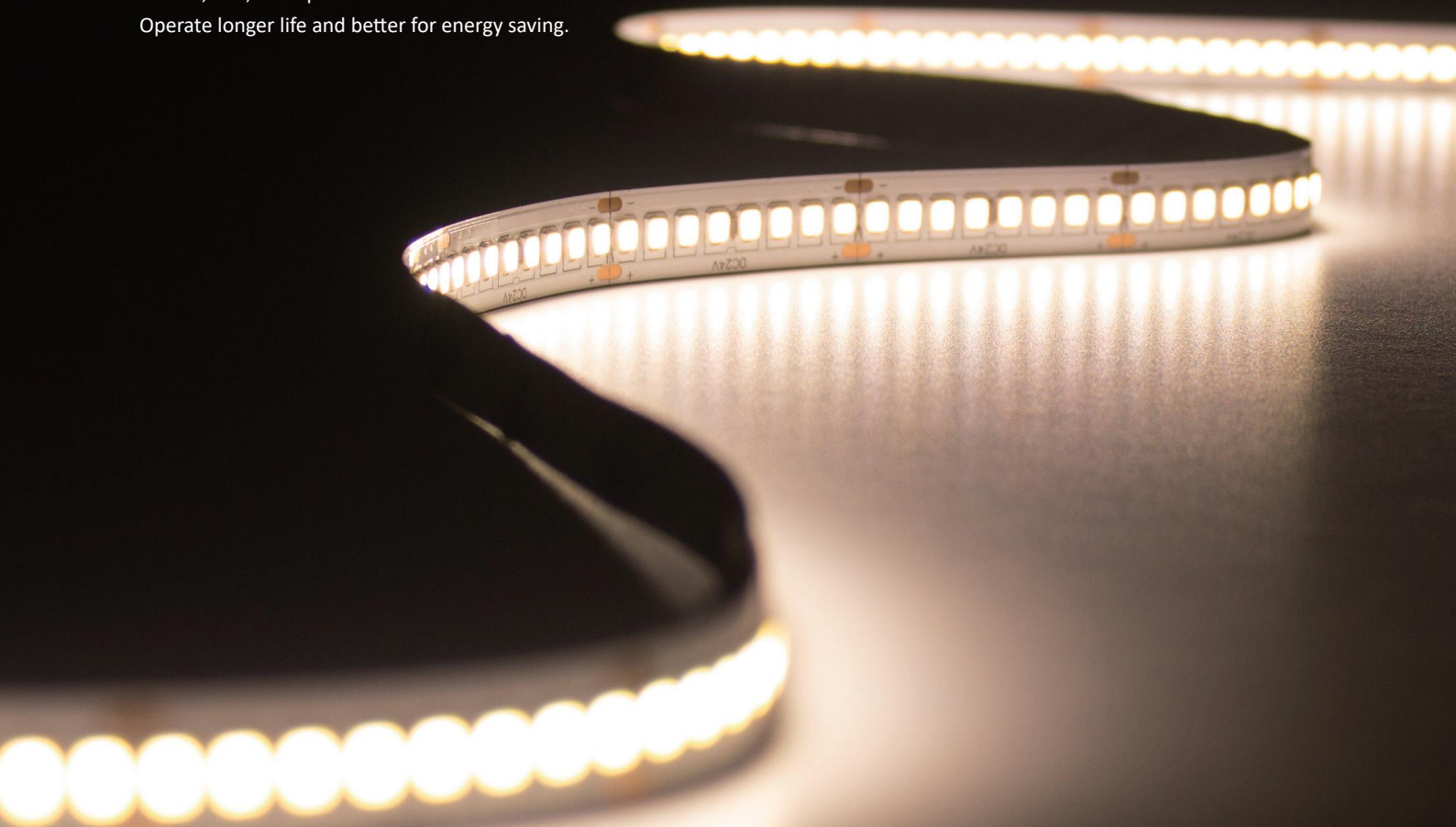

01

## HE2835-24V-64D-08-20

2835 64LEDS/M

- Khun Pass (EU) 2019/2015 regulation, Eco design conformed.
- Light efficiency up to 150LM/W, 180LM/W.
- Color temperature between 1800-10000K is optional.
- CRI80+, 90+, 95+ optional.
- Operate longer life and better for energy saving.



150 LM/W | 180 LM/W | IP54 | IP65 | IP67 | IP68 | 24V | 8 mm | 5M REEL

### Basic Parameters

Power	4.8W/m
Input Voltage	24VDC ( 12VDC )
Input Current	0.20A/m
Cutting Unit	8LEDs/125mm
Size	5000×8×1.5mm
Bend Diameter	>60mm
Copper foil	2oz

### Luminous Intensity Distribution

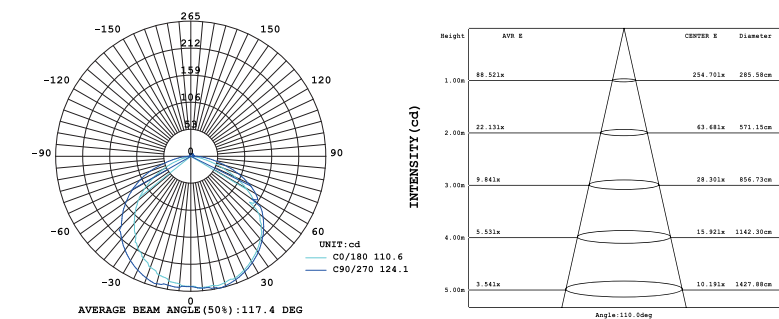

### Photo-electric Parameters

CRI	CCT (°K)	LM/M	LM/W	Energy Efficiency CLASS
>80	2700K	830	172	C
	3000K	830	172	C
	4000K	854	178	C
>90	6000K	854	178	C
	2700K	747	156	D
	3000K	747	156	D
	4000K	773	161	D
	6000K	773	161	D

### Recommended Accessories

Image	Code
	2PIN-18AWG
	SRW-8BB-2PIN
	V1+R6-1
	LRS-35-24



## 02 HE2835-24V-80D-10-20

2835 80LEDS/M

- Pass (EU) 2019/2015 regulation, Eco design conformed.
- Light efficiency up to 150LM/W, 180LM/W.
- Color temperature between 1800-10000K is optional.
- CRI80+, 90+, 95+ optional.
- Operate longer life and better for energy saving.



### Basic Parameters

Power	7.2W/m
Input Voltage	24VDC
Input Current	0.30A/m
Cutting Unit	8LEDs/100mm
Size	5000×10×1.5mm
Bend Diameter	>60mm
Copper foil	2oz

### Luminous Intensity Distribution

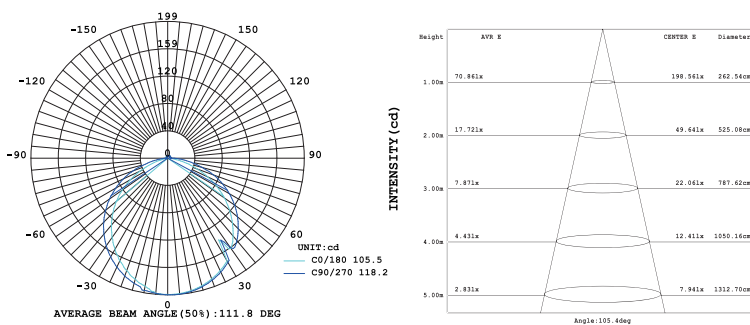

### Photo-electric Parameters

CRI	CCT (°K)	LM/M	LM/W	Energy Efficiency CLASS
>80	2700K	1232	171	C
	3000K	1232	171	C
	4000K	1287	178	C
	6000K	1287	178	C
>90	2700K	1112	154	D
	3000K	1112	154	D
	4000K	1160	161	D
	6000K	1160	161	D

### Recommended Accessories

Image				
Code	2PIN-18AWG	SRW-10BB-2PIN	V1+R6-1	LRS-50-24

## 03 HE2835-24V-128D-10-20

2835 128LEDS/M

- Pass (EU) 2019/2015 regulation, Eco design conformed.
- Light efficiency up to 150LM/W, 180LM/W.
- Color temperature between 1800-10000K is optional.
- CRI80+, 90+, 95+ optional.
- Operate longer life and better for energy saving.

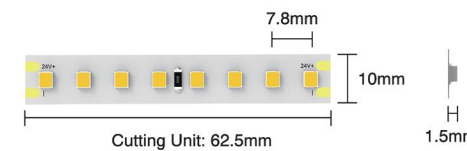

### Basic Parameters

Power	9.6W/m
Input Voltage	24VDC
Input Current	0.40A/m
Cutting Unit	8LEDs/62.5mm
Size	5000×10×1.5mm
Bend Diameter	>60mm
Copper foil	2oz/3oz

### Luminous Intensity Distribution

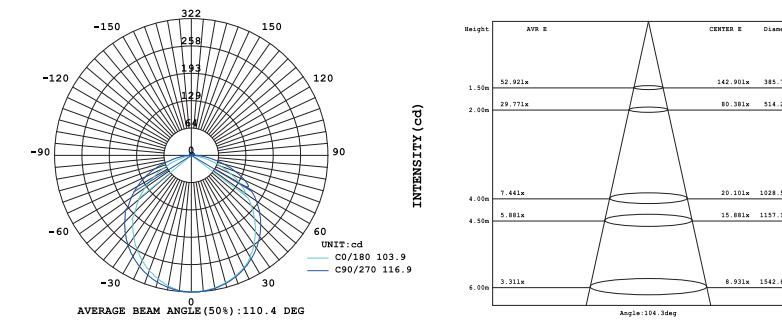

### Photo-electric Parameters

CRI	CCT (°K)	LM/M	LM/W	Energy Efficiency CLASS
>80	2700K	1679	174	D
	3000K	1679	174	D
	4000K	1717	178	C
	6000K	1717	178	C
>90	2700K	1499	156	D
	3000K	1499	156	D
	4000K	1546	161	D
	6000K	1546	161	D

### Recommended Accessories

Image				
Code	2PIN-18AWG	SRW-10BB-2PIN	V1+R6-1	LRS-75-24

## 04 HE2835-24V-160D-10-20

2835 160LEDS/M

- Pass (EU) 2019/2015 regulation, Eco design conformed.
- Light efficiency up to 150LM/W, 180LM/W.
- Color temperature between 1800-10000K is optional.
- CRI80+, 90+, 95+ optional.
- Operate longer life and better for energy saving.



150 LM/W 180 LM/W IP54 IP65 IP67 IP68 24V 10 mm 5M REEL

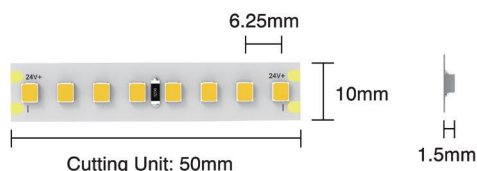

### Basic Parameters

Power	14.4W/m
Input Voltage	24VDC
Input Current	0.60A/m
Cutting Unit	8LEDs/50mm
Size	5000×10×1.5mm
Bend Diameter	> 60mm
Copper foil	2oz/3oz

### Luminous Intensity Distribution

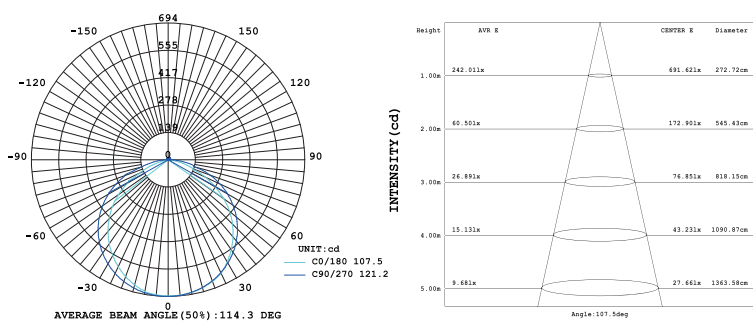

### Photo-electric Parameters

CRI	CCT (°K)	LM/M	LM/W	Energy Efficiency CLASS
>80	2700K	2520	174	C
	3000K	2520	174	C
	4000K	2581	179	C
	6000K	2581	179	C
>90	2700K	2254	156	D
	3000K	2254	156	D
	4000K	2336	162	D
	6000K	2336	162	D

### Recommended Accessories

Image	Code
	2PIN-18AWG
	SRW-10BB-2PIN
	V1+R6-1
	LRS-100-24

## 05 HE2835-24V-192D-10-20

2835 192LEDS/M

- Pass (EU) 2019/2015 regulation, Eco design conformed.
- Light efficiency up to 150LM/W, 180LM/W.
- Color temperature between 1800-10000K is optional.
- CRI80+, 90+, 95+ optional.
- Operate longer life and better for energy saving.



150 LM/W 180 LM/W IP54 IP65 IP67 IP68 24V 10 mm 5M REEL

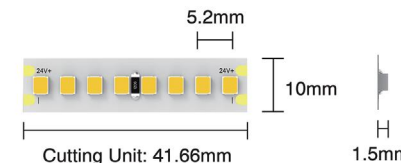

### Basic Parameters

Power	18W/m
Input Voltage	24VDC
Input Current	0.75A/m
Cutting Unit	8LEDs/41.67mm
Size	5000×10×1.5mm
Bend Diameter	> 60mm
Copper foil	2oz/3oz

### Luminous Intensity Distribution

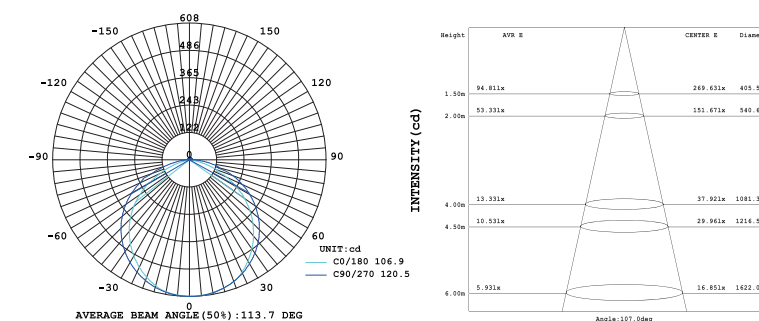

### Photo-electric Parameters

CRI	CCT (°K)	LM/M	LM/W	Energy Efficiency CLASS
>80	2700K	3149	174	C
	3000K	3149	174	C
	4000K	3234	179	C
	6000K	3234	179	C
>90	2700K	2834	157	D
	3000K	2834	157	D
	4000K	2940	163	D
	6000K	2940	163	D

### Recommended Accessories

Image	Code
	2PIN-18AWG
	SRW-10BB-2PIN
	V1+R6-1
	LRS-100-24

## 06 HE2835-24V-240D-10-20

2835 240LEDS/M

- Pass (EU) 2019/2015 regulation, Eco design conformed.
- Light efficiency up to 150LM/W, 180LM/W.
- Color temperature between 1800-10000K is optional.
- CRI80+, 90+, 95+ optional.
- Operate longer life and better for energy saving.

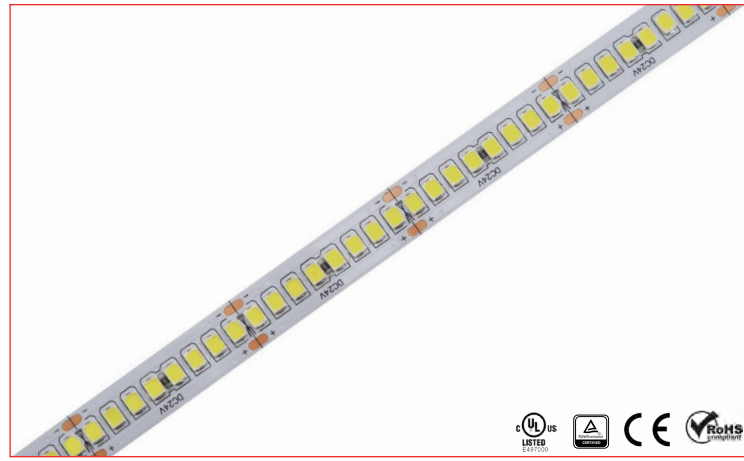
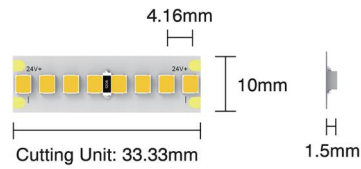

### Basic Parameters

Power	21.6W/m
Input Voltage	24VDC
Input Current	0.90A/m
Cutting Unit	8LEDs/33.33mm
Size	5000×10×1.5mm
Bend Diameter	>60mm
Copper foil	2oz/3oz

### Luminous Intensity Distribution

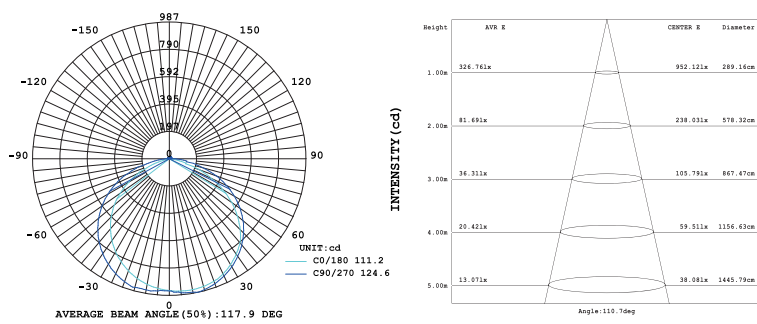

### Photo-electric Parameters

CRI	CCT (°K)	LM/M	LM/W	Energy Efficiency CLASS
>80	2700K	3732	172	C
	3000K	3732	172	C
	4000K	3840	178	C
	6000K	3840	178	C
>90	2700K	3360	156	D
	3000K	3360	156	D
	4000K	3479	161	D
	6000K	3479	161	D

### Recommended Accessories

Image	Code
	2PIN-18AWG
	SRW-10BB-2PIN
	V1+R6-1
	LRS-150-24

## 07 HP2835-24V-90D-10-20

2835 90LEDS/M

- Pass (EU) 2019/2015 regulation, Eco design conformed.
- Light efficiency up to 180LM/W, 200LM/W.
- Color temperature between 2700-6500K is optional.
- CRI80+, 90+, 95+ optional.
- Operate longer life and better for energy saving.

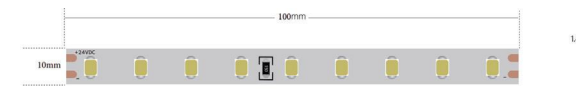

### Basic Parameters

Power	6W/m
Input Voltage	24VDC
Input Current	0.2A/m
Cutting Unit	9LEDs/100mm
Size	5000×10×1.47mm
Bend Diameter	>60mm
Copper foil	2oz/3oz

### Luminous Intensity Distribution

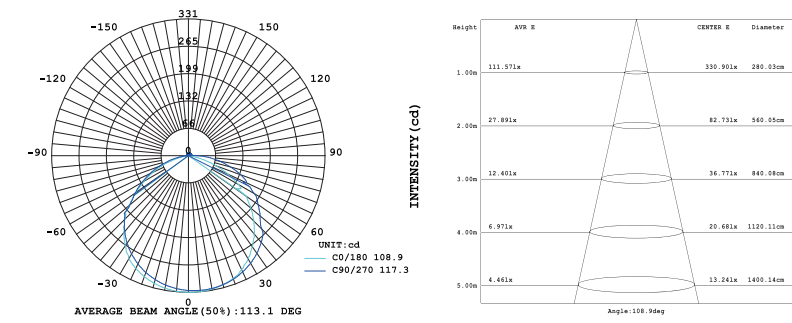

### Photo-electric Parameters

CRI	CCT (°K)	LM/M	LM/W	Energy Efficiency CLASS
>80	2700K	1190	212	C
	3000K	1190	212	C
	4000K	1246	222	B
>90	2700K	1005	189	D
	3000K	1005	189	D
	4000K	1052	198	C
	6000K	1052	198	C

### Recommended Accessories

Image	Code
	2PIN-18AWG
	SRW-10BB-2PIN
	V1+R6-1
	LRS-50-24

## 08 HP2835-24V-180D-10-20

2835 180LEDS/M

- Pass (EU) 2019/2015 regulation, Eco design conformed.
- Light efficiency up to 180LM/W, 200LM/W.
- Color temperature between 2700-6500K is optional.
- CRI80+, 90+, 95+ optional.
- Operate longer life and better for energy saving.

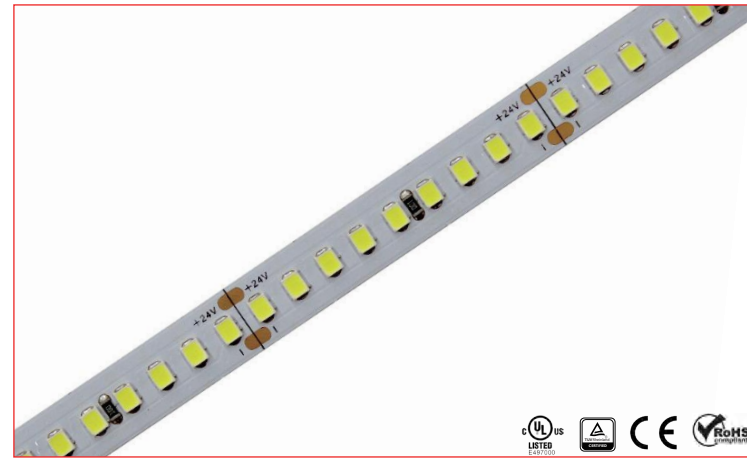
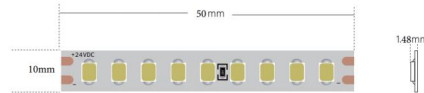

### Basic Parameters

Power	12W/m
Input Voltage	24VDC
Input Current	0.2A/m
Cutting Unit	9LEDs/50mm
Size	5000×10×1.48mm
Bend Diameter	>60mm
Copper foil	2oz/3oz

### Luminous Intensity Distribution

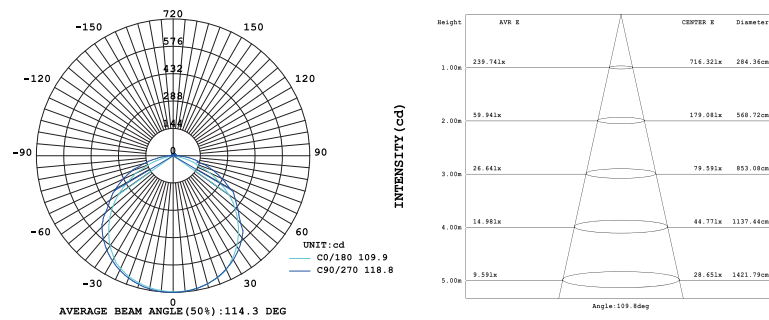

### Photo-electric Parameters

CRI	CCT (°K)	LM/M	LM/W	Energy Efficiency CLASS
>80	2700K	2519	193	B
	3000K	2519	193	B
	4000K	2650	203	B
	6000K	2650	203	B
>90	2700K	2369	186	C
	3000K	2369	186	C
	4000K	2497	196	B
	6000K	2497	196	B

### Recommended Accessories

Image				
Code	2PIN-18AWG	SRW-10BB-2PIN	V1+R6-1	LRS-75-24

## 09 HP2835-24V-108D-10-20

2835 108LEDS/M

- Pass (EU) 2019/2015 regulation, Eco design conformed.
- Light efficiency up to 180LM/W, 200LM/W.
- Color temperature between 2700-6500K is optional.
- CRI80+, 90+, 95+ optional.
- Operate longer life and better for energy saving.

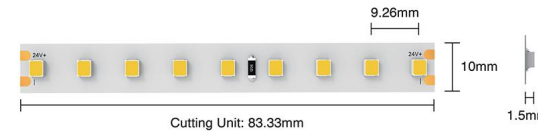

### Basic Parameters

Power	7.2W/m
Input Voltage	24VDC
Input Current	0.2A/m
Cutting Unit	9LEDs/83.33mm
Size	5000×10×1.5mm
Bend Diameter	>60mm
Copper foil	2oz/3oz

### Luminous Intensity Distribution

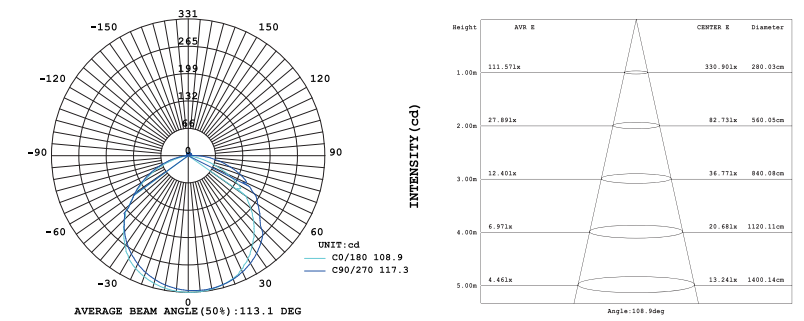

### Photo-electric Parameters

CRI	CCT (°K)	LM/M	LM/W	Energy Efficiency CLASS
>80	2700K	1576	201	B
	3000K	1576	201	B
	4000K	1646	211	A
	6000K	1646	211	A
>90	2700K	1485	192	B
	3000K	1485	192	B
	4000K	1553	201	B
	6000K	1553	201	B

### Recommended Accessories

Image				
Code	2PIN-18AWG	SRW-10BB-2PIN	V1+R6-1	LRS-50-24



## 10 HP2835-24V-162D-10-20

2835 162LEDS/M

- Pass (EU) 2019/2015 regulation, Eco design conformed.
- Light efficiency up to 180LM/W, 200LM/W.
- Color temperature between 2700-6500K is optional.
- CRI80+, 90+, 95+ optional.
- Operate longer life and better for energy saving.

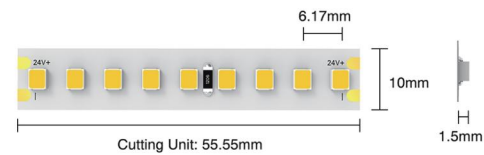

### Basic Parameters

Power	10.8W/m
Input Voltage	24VDC
Input Current	0.2A/m
Cutting Unit	9LEDs/55.55mm
Size	5000×10×1.5mm
Bend Diameter	>60mm
Copper foil	2oz/3oz

### Luminous Intensity Distribution

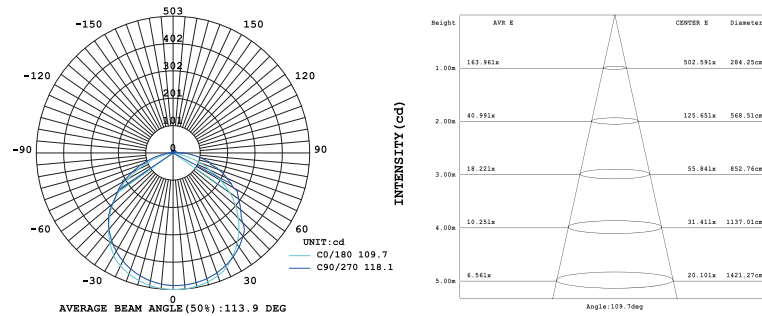

### Photo-electric Parameters

CRI	CCT (°K)	LM/M	LM/W	Energy Efficiency CLASS
>80	2700K	2047	198	C
	3000K	2047	198	C
	4000K	2151	208	C
	6000K	2151	208	C
>90	2700K	1981	192	C
	3000K	1981	192	C
	4000K	2157	202	C
	6000K	2157	202	C

### Recommended Accessories

Image				
Code	2PIN-18AWG	SRW-10BB-2PIN	V1+R6-1	LRS-75-24

## 11 HP2835-24V-234D-10-20

2835 234LEDS/M

- Pass (EU) 2019/2015 regulation, Eco design conformed.
- Light efficiency up to 180LM/W, 200LM/W.
- Color temperature between 2700-6500K is optional.
- CRI80+, 90+, 95+ optional.
- Operate longer life and better for energy saving.

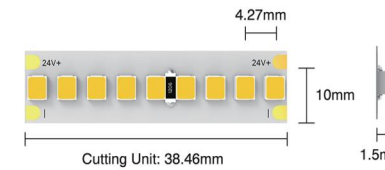

### Basic Parameters

Power	15.6W/m
Input Voltage	24VDC
Input Current	0.2A/m
Cutting Unit	9LEDs/38.46mm
Size	5000×10×1.5mm
Bend Diameter	>60mm
Copper foil	2oz/3oz

### Luminous Intensity Distribution

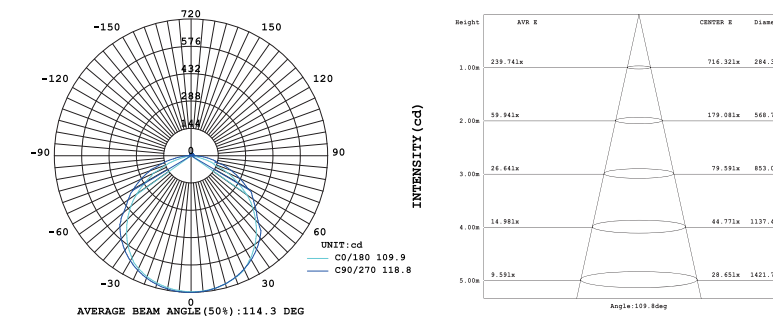

### Photo-electric Parameters

CRI	CCT (°K)	LM/M	LM/W	Energy Efficiency CLASS
>80	2700K	2083	192	C
	3000K	2083	192	C
	4000K	2192	202	B
	6000K	2192	202	B
>90	2700K	1963	181	C
	3000K	1963	181	C
	4000K	2040	188	C
	6000K	2040	188	C

### Recommended Accessories

Image				
Code	2PIN-18AWG	SRW-10BB-2PIN	V1+R6-1	LRS-100-24





# ULTRA-LONG SERIES

## 12 CC2835-24V-60D-10-20

2835 60LEDS/M

- 50M long strip driven by one end.
- 100M long strip driven by two ends power supply, with same brightness from front to end.
- Source by Top 2835 LEDs, and IC for constant current.
- Pass ERP new regulation.
- 2700K-6500K is optional.

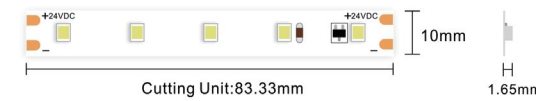

### Basic Parameters

Power	2.88W/m
Input Voltage	24VDC
Input Current	0.12A/m
Cutting Unit	5LEDs/83.33mm
Size	5000×10×1.65mm
Bend Diameter	>60mm
Copper foil	3oz



### Luminous Intensity Distribution

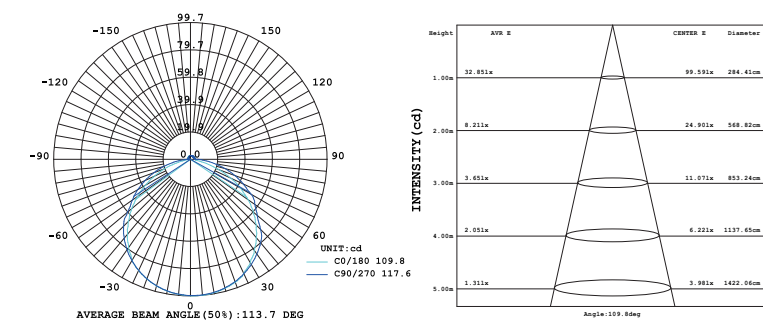

### Photo-electric Parameters

CRI	CCT (°K)	LM/M	LM/W	Energy Efficiency CLASS
>80	2700K	300	104	F
	3000K	300	104	F
	4000K	314	109	F
	6000K	314	109	F

### Recommended Accessories

Image	Code	Code	Code	Code
	2PIN-18AWG		SRW-10BB-2PIN	
			LRS-35-24	



## Khun Ultra-long Series

24V/48V Better performance  
Ultra-long LED Strips

Long length in the uniform color.  
15M/20M/25M/30M/50M long led strip light driven by one end power supply with same brightness from front to end.

**13 CC2835-24V-60D-10-20**

2835 60LEDS/M

- 25M long strip driven by one end.
- 50M long strip driven by two ends power supply, with same brightness from front to end.
- Source by Top 2835 LEDs, and IC for constant current.
- Pass ERP new regulation.
- 2700K-6500K is optional.

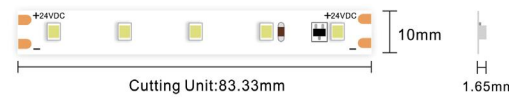

UL, 50M Reel, IP54, IP65, IP67, IP68, 24V, 10mm

**Basic Parameters**

Power	5.76W/m
Input Voltage	24VDC
Input Current	0.24A/m
Cutting Unit	5LEDs/83.33mm
Size	5000×10×1.65mm
Bend Diameter	>60mm
Copper foil	3oz

**Luminous Intensity Distribution**

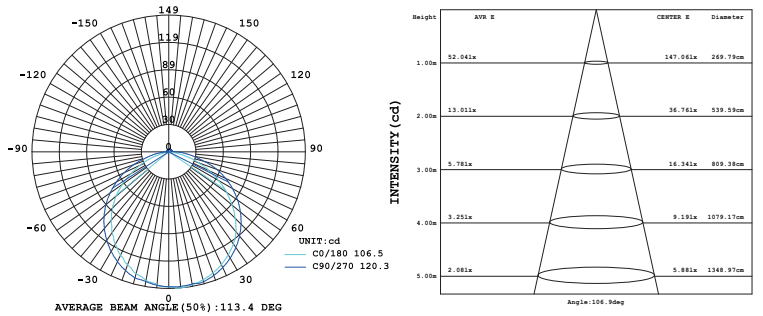

**Photo-electric Parameters**

	CCT (°K)	LM/M	LM/W	Energy Efficiency CLASS
>80	2700K	564	98	F
	3000K	564	98	F
	4000K	593	103	F
	6000K	593	103	F

**Recommended Accessories**

Image				
Code	2PIN-18AWG	SRW-10BB-2PIN	V1+R6-1	LRS-35-24

**14 CC2835-24V-120D-10-20**

2835 120LEDS/M

- 20M long strip driven by one end.
- 40M long strip driven by two ends power supply, with same brightness from front to end.
- Source by Top 2835 LEDs, and IC for constant current.
- Pass ERP new regulation.
- 2700K-6500K is optional.

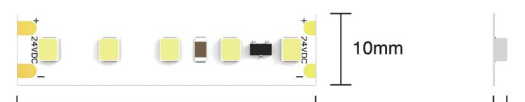
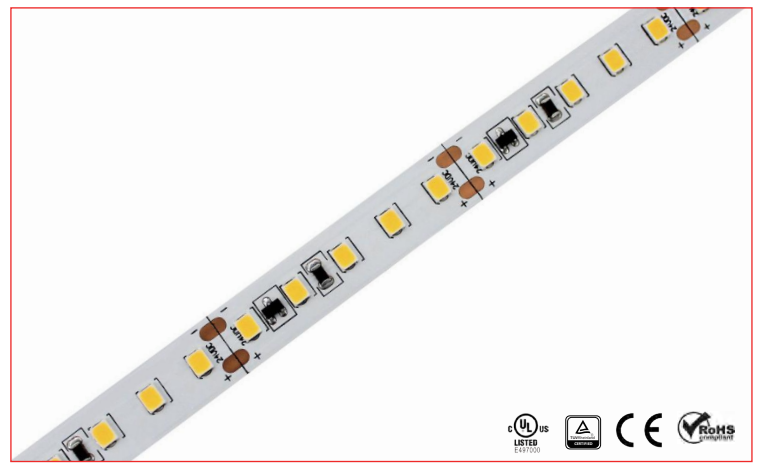

UL, 40M Reel, IP54, IP65, IP67, IP68, 24V, 10mm

**Basic Parameters**

Power	8.64W/m
Input Voltage	24VDC
Input Current	0.36A/m
Cutting Unit	5LEDs/42mm
Size	5000×10×1.5mm
Bend Diameter	>60mm
Copper foil	3oz

**Luminous Intensity Distribution**

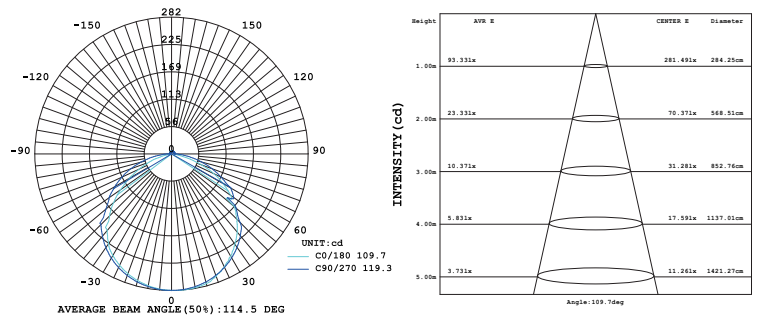

**Photo-electric Parameters**

	CCT (°K)	LM/M	LM/W	Energy Efficiency CLASS
>80	2700K	857	99	F
	3000K	857	99	F
	4000K	900	104	F
	6000K	900	104	F

**Recommended Accessories**

Image				
Code	2PIN-18AWG	SRW-10BB-2PIN	V1+R6-1	LRS-50-24



**15 CC2835-24V-160D-10-20**

2835 160LEDS/M

- 10M long strip driven by one end.
- 20M long strip driven by two ends power supply, with same brightness from front to end.
- Source by Top 2835 LEDs, and IC for constant current.
- Pass ERP new regulation.
- 2700K-6500K is optional.

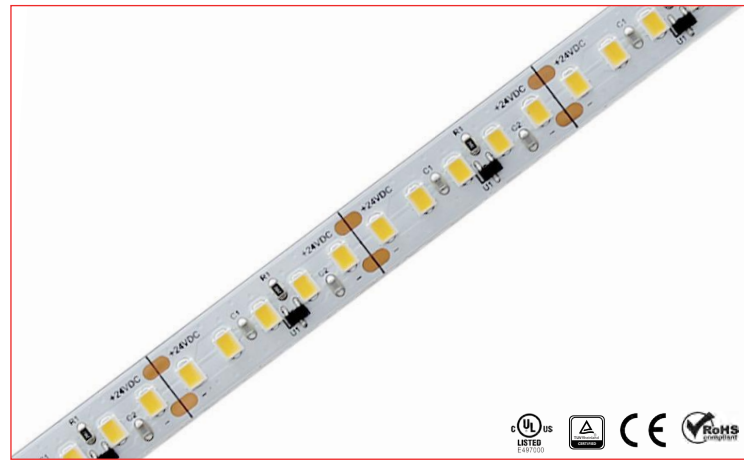
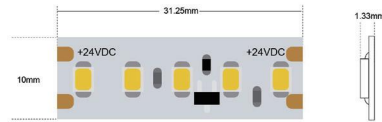

Basic Parameters

Power	7.5W/m
Input Voltage	24VDC
Input Current	0.3266A/m
Cutting Unit	5LEDs/31.25mm
Size	5000×10×1.33mm
Bend Diameter	>60mm
Copper foil	2oz

Luminous Intensity Distribution

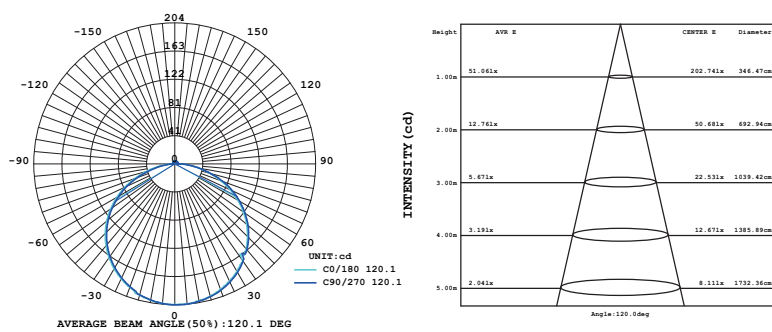

Photo-electric Parameters

	CCT (°K)	LM/M	LM/W	Energy Efficiency CLASS
>90	2700K	675	90	F
	3000K	675	90	F
	4000K	713	95	F
	6000K	713	95	F

Recommended Accessories

Image				
Code	2PIN-18AWG	SRW-10BB-2PIN	V1+R6-1	LRS-50-24

**16 CC2835-48V-72D-12-20**

2835 72LEDS/M

- 30M long strip driven by one end.
- 60M long strip driven by two ends power supply, with same brightness from front to end.
- Source by Top 2835 LEDs, and IC for constant current.
- Pass ERP new regulation.
- 2700K-6500K is optional.



Basic Parameters

Power	6.5W/m
Input Voltage	48VDC
Input Current	0.1354A/m
Cutting Unit	12LEDs/166.5mm
Size	5000×12×1.8mm
Bend Diameter	>60mm
Copper foil	3oz

Luminous Intensity Distribution

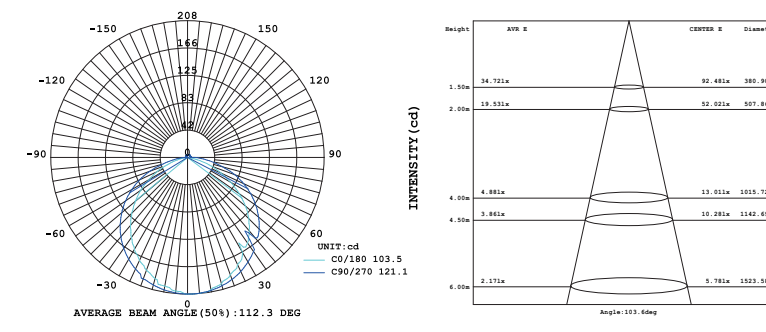

Photo-electric Parameters

	CCT (°K)	LM/M	LM/W	Energy Efficiency CLASS
>80	2700K	728	112	F
	3000K	728	112	F
	4000K	767	118	F
	6000K	767	118	F

Recommended Accessories

Image				
Code	2PIN-18AWG	SRW-12BB-2PIN	V1+R6-1	LRS-50-48

## 17 UL2835-48V-160D-8-20

2835 160LEDS/M

- 20M long strip driven by one end.
- 40M long strip driven by two ends power supply, with same brightness from front to end.
- Source by Top 2835 LEDs, no IC solution.
- Pass ERP new regulation.
- 2700K-6500K is optional.

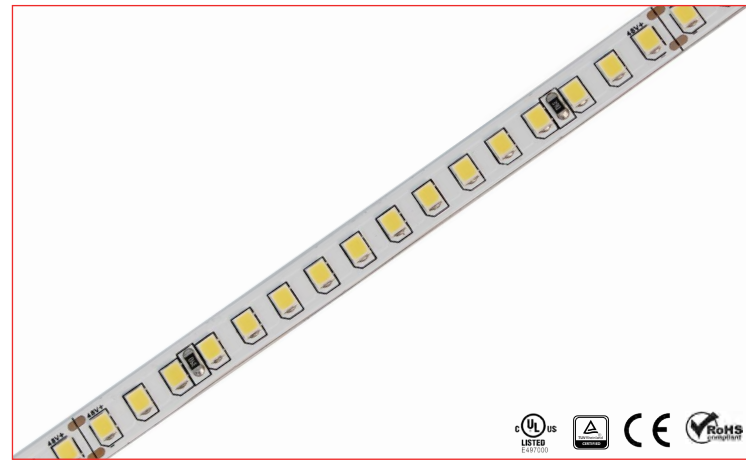
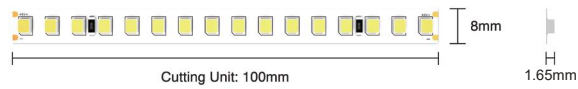

### Basic Parameters

Power	14W/m
Input Voltag	48VDC
Input Current	0.2916A/m
Cutting Unit	16LEDs/100mm
Size	5000×8×1.65mm
Bend Diameter	>60mm
Copper foil	3oz

### Luminous Intensity Distribution

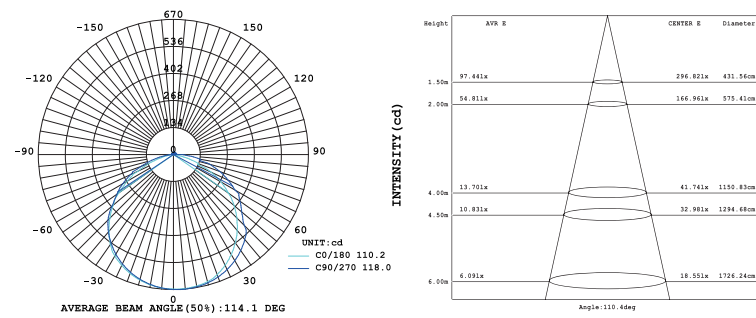

### Photo-electric Parameters

	CCT (°K)	LM/M	LM/W	Energy Efficiency CLASS
>80	2700K	1974	141	E
	3000K	1974	141	E
	4000K	2072	148	D
	6000K	2072	148	D

### Recommended Accessories

Image				
Code	2PIN-18AWG	SRW-8BB-2PIN	V1+R6-1	LRS-100-48

## 18 CC5050RGBW-24V-60D-12-20

5050 60LEDS/M

- 15M long strip driven by one end.
- 30M long strip driven by two ends power supply, with same brightness from front to end.
- Source by Top 5050 LEDs, and IC for constant current.
- Four channel flexible led strip with RGB+W/NW/CW, 4 in1 chip SMD.

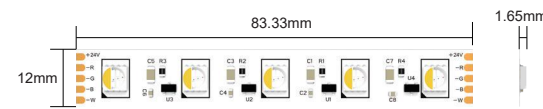

### Basic Parameters

Power	11W/m
Input Voltag	24VDC
Input Current	0.484A/m
Cutting Unit	5LEDs/83.33mm
Size	5000×12×1.65mm
Bend Diameter	>60mm
Copper foil	3oz

### Luminous Intensity Distribution

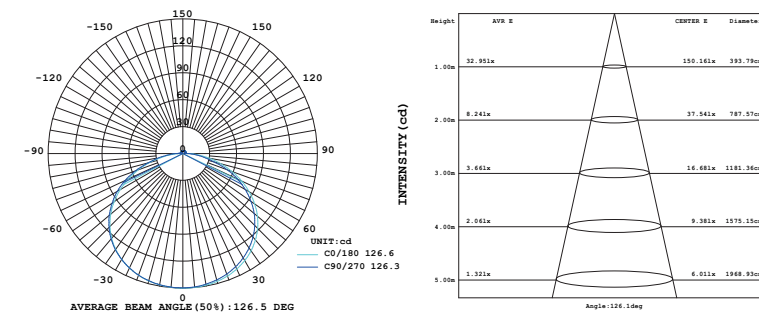

### Photo-electric Parameters

	CCT (°K)	LM/M	LM/W
>80	RGBW( 2700K)	403	37
	RGBW( 3000K)	403	37
	RGBW( 4000K)	533	46
	RGBW( 6000K)	533	46

### Recommended Accessories

Image				
Code	5PIN-20AWG	SRW-12BB-5PIN	V3+R8-1	LRS-75-24

**19 CC5050RGBW-24V-90D-12-20**

2835 90LEDS/M

- 12M long strip driven by one end.
- 24M long strip driven by two ends power supply, with same brightness from front to end.
- Source by Top 5050 LEDs, and IC for constant current.
- Four channel flexible led strip with RGB+W/NW/Cw, 4in 1 chip SMD.

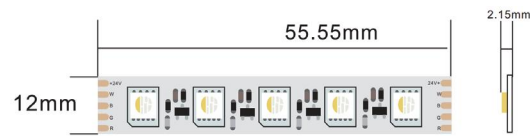

Basic Parameters

Power	18W/m
Input Voltag	24VDC
Input Current	0.7214A/m
Cutting Unit	5LEDs/55.55mm
Size	5000×12×2.15mm
Bend Diameter	>60mm
Copper foil	3oz

Luminous Intensity Distribution

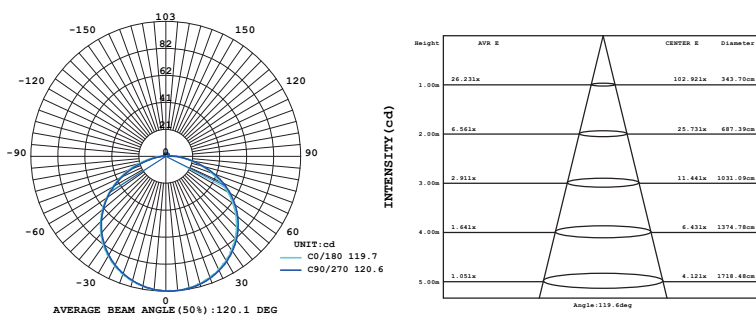

Photo-electric Parameters

	CCT (°K)	LM/M	LM/W
>80	RGBW( 2700K)	779	43
	RGBW( 3000K)	779	43
	RGBW( 4000K)	787	45
	RGBW( 6000K)	787	45

Recommended Accessories

Image				
Code	5PIN-20AWG	SRW-12BB-5PIN	V3+R8-1	LRS-100-24

**20 CC2835CA-24V-196D-10-20**

2835 196LEDS/M

- 10M long strip driven by one end.
- 20M long strip driven by two ends power supply, with same brightness from front to end.
- Source by Top 2835 LEDs, and IC for constant current.
- Pass ERP new regulation.
- CCT Dual color adjustable from 2700K-6500K.

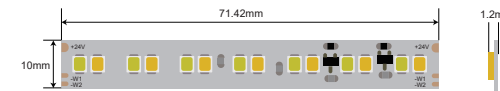

Basic Parameters

Power	11W/m
Input Voltag	24VDC
Input Current	0.4583A/m
Cutting Unit	14LEDs/71.42mm
Size	5000×10×1.2mm
Bend Diameter	>60mm
Copper foil	3oz

Luminous Intensity Distribution

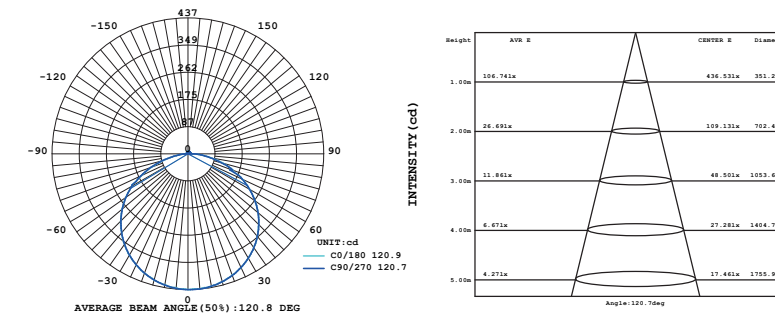

Photo-electric Parameters

	CCT (°K)	LM/M	LM/W	Energy Efficiency CLASS
>80	2700K	820	149	D
	4000K	1628	148	D
	6000K	797	145	E
>90	2700K	781	142	E
	4000K	1551	141	E
	6000K	759	138	E

Recommended Accessories

Image			
Code	3PIN-20AWG	V2+R7-1	LRS-75-24



# ULTRA-LONG SERIES

## 21 CC2835HE-24V-192D-10-20

2835 192LEDS/M

- 10M long strip driven by one end.
- 20M long strip driven by two ends power supply, with same brightness from front to end.
- Source by High Brightness 2835 LEDs, and IC for constant current.
- Pass ERP new regulation, can up to C class
- 2700K-6500K is optional .

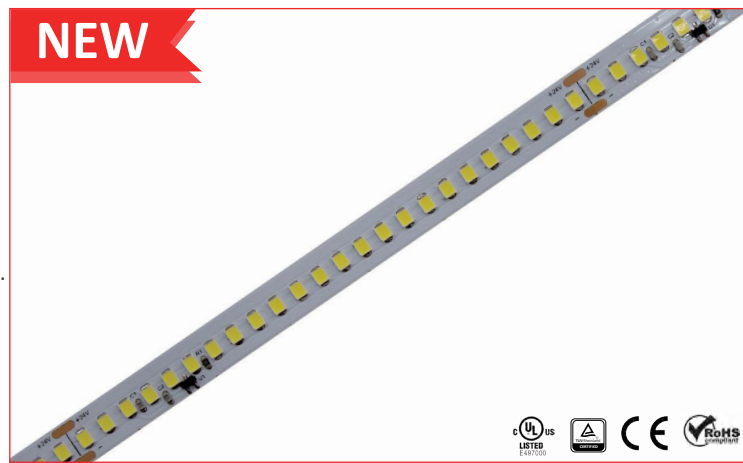
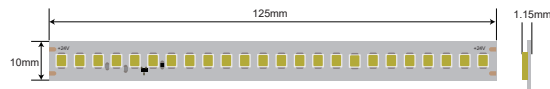

### Basic Parameters

Power	11W/m
Input Voltag	24VDC
Input Current	0.4583A/m
Cutting Unit	24LEDs/125mm
Size	5000×10×1.15mm
Bend Diameter	>60mm
Copper foil	3oz

### Luminous Intensity Distribution

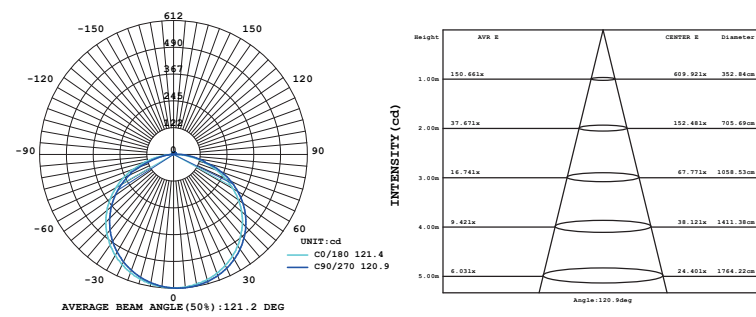

### Photo-electric Parameters

	CCT (°K)	LM/M	LM/W	Energy Efficiency CLASS
>80	2700K	2035	185	C
	3000K	2035	185	C
	4000K	2145	195	C
	6000K	2145	195	C

### Recommended Accessories

Image	Code
	2PIN-18AWG
	RW-10BB-2PIN
	V1+R6-1
	LRS-75-24

## Khun Super narrow Series

only 3mm/4mm/5mm width  
Super Narrow LED Strips

Linear emitting performance, high reliability, excellent anti-bending ability.  
Ideal for art lighting and mounting on furniture edge.  
low power consumption.



**22 UN2216-24V-144D-03-20**

2216 144LEDS/M

- Ultra-narrow, only 3mm width PCB, for more limited places.
- Source by more cost-effective SMD2216 Plus with uniform illumination.
- Better anti-bending, anti-breaking.
- CRI90+, 95+ available.
- Customized wattage, Luminous Flux per M.



3mm Width | Pass ERP | CRI 90 | IP54 | 24V | 5M REEL

Basic Parameters

Power	11.2W/m
Input Voltage	24VDC
Input Current	0.466A/m
Cutting Unit	8LEDs/55.5mm
Size	5000×3×1.1mm
Bend Diameter	>60mm
Copper foil	2oz

Luminous Intensity Distribution

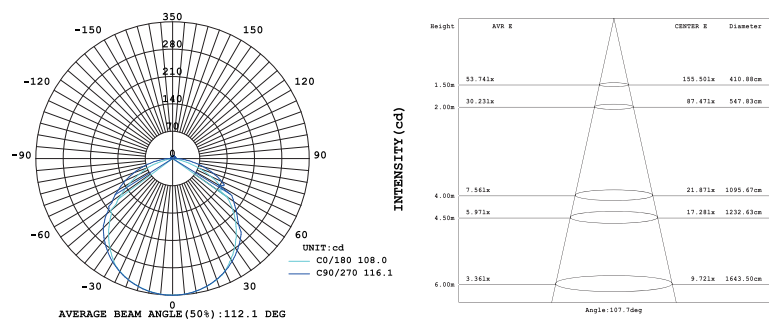

Photo-electric Parameters

CRI	CCT (°K)	LM/M	LM/W	Energy Efficiency CLASS
>90	2700K	1210	108	F
	3000K	1210	108	F
	4000K	1265	113	F
	6000K	1265	113	F

Recommended Accessories

Image: Code: 2PIN-22AWG | V1+R6-1 | LRS-75-24

**23 UN2216-24V-288D-03-20**

2216 288LEDS/M

- Ultra-narrow, only 3mm width PCB, for more limited places.
- Source by more cost-effective SMD2216 Plus with uniform illumination.
- Better anti-bending, anti-breaking.
- CRI90+, 95+ available.
- Customized wattage, Luminous Flux per M.

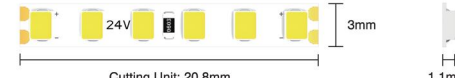

High Density | 3mm Width | CRI 90 | IP54 | 24V | 5M REEL

Basic Parameters

Power	14W/m
Input Voltage	24VDC
Input Current	0.583A/m
Cutting Unit	6LEDs/20.8mm
Size	5000×3×1.1mm
Bend Diameter	>60mm
Copper foil	2oz

Luminous Intensity Distribution

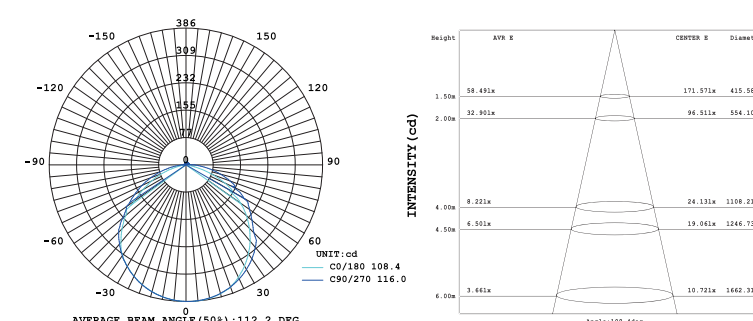

Photo-electric Parameters

CRI	CCT (°K)	LM/M	LM/W	Energy Efficiency CLASS
>90	2700K	1162	83	/
	3000K	1162	83	/
	4000K	1244	88	/
	6000K	1244	88	/

Recommended Accessories

Image: Code: 2PIN-22AWG | V1+R6-1 | LRS-100-24

**24 UN2110-24V-352D-04-20**

2110 352LEDS/M

- Ultra-narrow, only 4mm width PCB, for more limited places.
- Source by high output 2110 Led with uniform illumination.
- CRI90+ available.
- High Brightness, Efficiency, Customized wattage, Luminous Flux per M.



4mm Width Pass ERP CRI 90 IP54 24V 5M REEL

**Luminous Intensity Distribution**

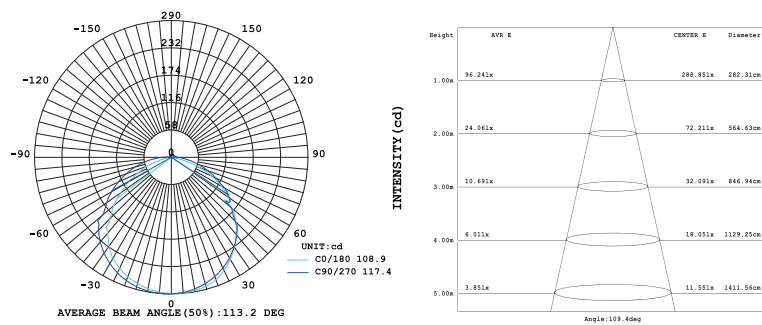

**Basic Parameters**

Power	9W/m
Input Voltage	24VDC
Input Current	0.375A/m
Cutting Unit	8LEDs/22.6mm
Size	5000×4×1.5mm
Bend Diameter	>60mm
Copper foil	2oz

**Photo-electric Parameters**

CRI	CCT (°K)	LM/M	LM/W	Energy Efficiency CLASS
>90	2700K	945	105	F
	3000K	945	105	F
	4000K	990	110	F
	6000K	990	110	F

**Recommended Accessories**

Image Code 2PIN-22AWG V1+R6-1 LRS-75-24

**25 UN2835-24V-210D-05-20**

2835 210LEDS/M

- Ultra-narrow, only 5mm width PCB, for more limited places.
- Source by high output 2835 Led with uniform illumination.
- CRI80+, 90+ available.
- High Brightness, Efficiency, Customized wattage, Luminous Flux per M.

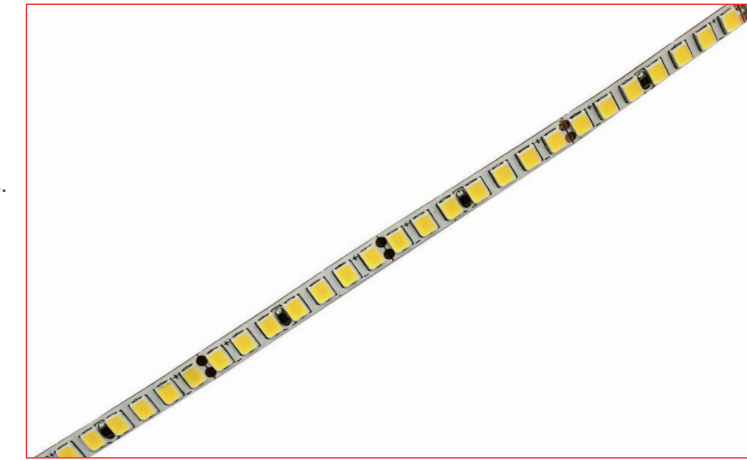

5mm Width Pass ERP IP54 IP67 IP68 24V 5M REEL

**Luminous Intensity Distribution**

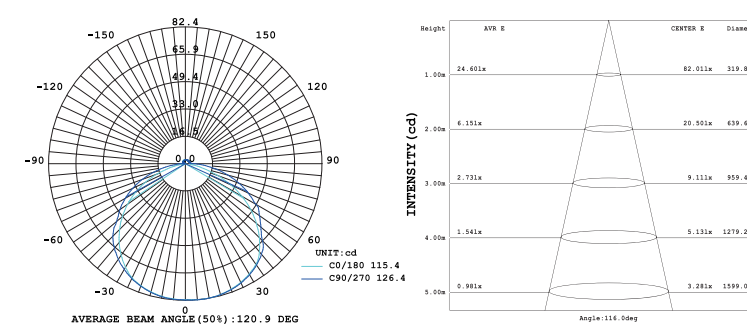

**Basic Parameters**

Power	10W/m
Input Voltage	24VDC
Input Current	0.416A/m
Cutting Unit	7LEDs/33.5mm
Size	5000×5×1.3mm
Bend Diameter	>60mm
Copper foil	2oz

**Photo-electric Parameters**

CRI	CCT (°K)	LM/M	LM/W	Energy Efficiency CLASS
>80	2700K	1130	113	F
	3000K	1130	113	F
	4000K	1190	119	E
	6000K	1190	119	E

**Recommended Accessories**

Image Code 2PIN-22AWG HM-N5BB-2PIN V1+R6-1 LRS-75-24



## 26 UN5050RGB-24V-108D-06-20

5050 108LEDS/M

- Ultra-narrow, only 6mm width PCB, for more limited places.
- 5050 RGB Led as light source, stable and high brightness.
- Compatible with most of RGB controllers in the market.
- Ideal for office, residential, retail and industry lighting.

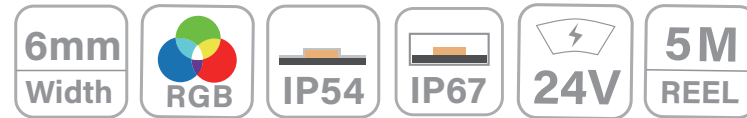
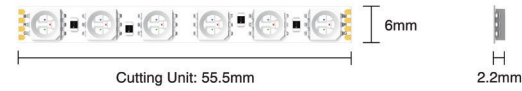

### Basic Parameters

Power	14W/m
Input Voltage	24VDC
Input Current	0.583A/m
Cutting Unit	6LEDs/55.5mm
Size	5000×6×2.2mm
Bend Diameter	>60mm
Copper foil	3oz

### Luminous Intensity Distribution

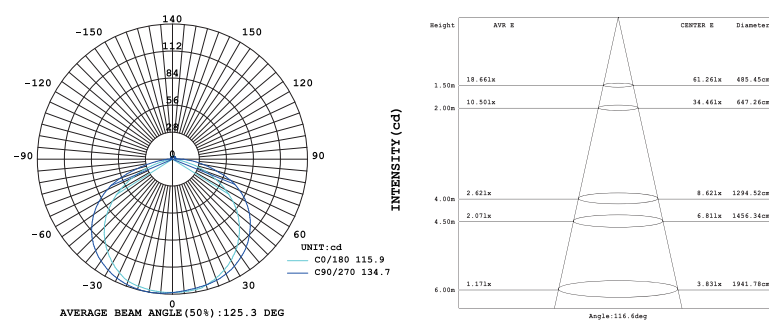

### Photo-electric Parameters

COLOR	LM/M	LM/W
RGB <span style="color:red">■</span> <span style="color:green">■</span> <span style="color:blue">■</span>	574	41

### Recommended Accessories

Image			
Code	4PIN-22AWG	V3+R6-1	LRS-100-24

## 27 UN2022-24V-280D-3-20

2022 280LEDS/M

- Source by New & high output 2022 Top Led with uniform illumination;
- High Brightness, Efficiency, Customized Wattage, Cost Effective;
- Ultra narrow only 3MM width;
- Pass New EU (2019/2015) regulation, Eco design conformed;
- Cost-effective solutions with better prices.

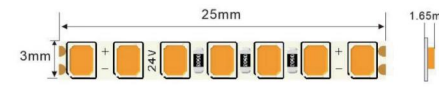

### Basic Parameters

Power	8W/m
Input Voltage	24VDC
Input Current	0.369A/m
Cutting Unit	7LEDs/25mm
Size	5000×5×1.65mm
Bend Diameter	>60mm
Copper foil	2oz

### Luminous Intensity Distribution

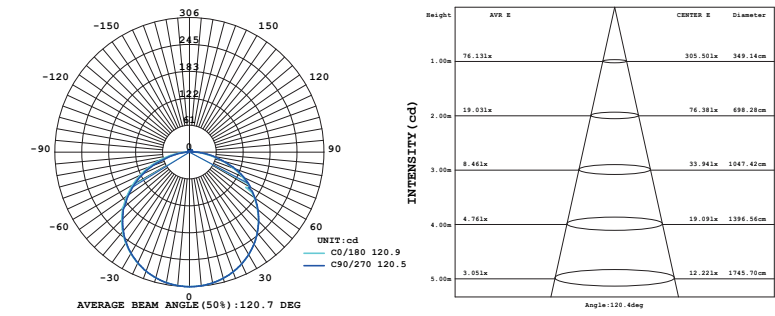

### Photo-electric Parameters

CRI	CCT (°K)	LM/M	LM/W	Energy Efficiency CLASS
>80	3000K <span style="color:orange">■</span>	824	103	F
	4000K <span style="color:orange">■</span>	872	109	F
	6000K <span style="color:lightblue">■</span>	872	109	F

### Recommended Accessories

Image			
Code	2PIN-22AWG	V1+R6-1	LRS-75-24







## Khun Mini cut Series

Cut Anywhere  
Mini Cut LED Strips

Each LED can be cut to fit different lengths of lighting fixtures.  
Perfect for customize design length project.  
Ideal for DIY.



## MINI CUT SERIES

### 28 MC2835-24V-120D-10-20

2835 120LEDS/M 8.33MM cut

- 1 led per cut, only 8.33mm, ideal for DIY.
- Pass (EU) 2019/2015 regulation, Eco design compliant.
- Mini cutting design, suitable for cutting in various length.
- Ideal for office, residential, retail and industry lighting.

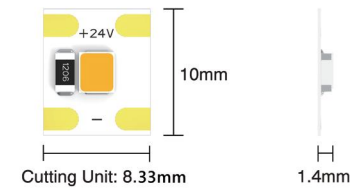

### Basic Parameters

Power	14W/m
Input Voltage	24VDC
Input Current	0.583A/m
Cutting Unit	1LEDs/8.33mm
Size	5000×10×1.4mm
Bend Diameter	>60mm
Copper foil	3oz

### Luminous Intensity Distribution

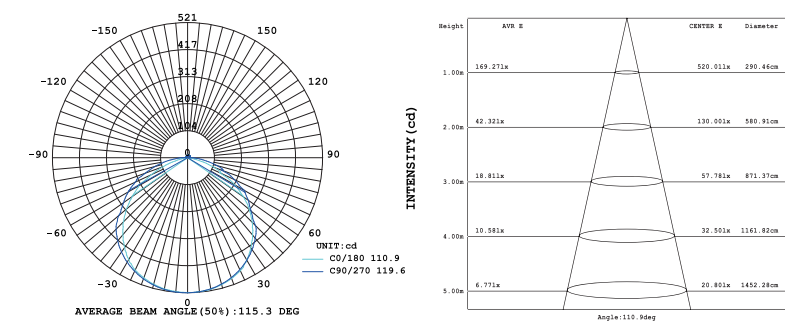

### Photo-electric Parameters

CRI	CCT (°K)	LM/M	LM/W	Energy Efficiency CLASS
>80	2700K	1554	111	F
	3000K	1554	111	F
	4000K	1610	115	F
	6000K	1610	115	F

### Recommended Accessories

Image	Code
	2PIN-18AWG
	V1+R6-1
	LRS-100-24

**29 MC2835-12V-100D-10-20**

2835 100LEDS/M 20MM cut

- 2 leds per cut, only 20mm, ideal for DIY.
- Pass (EU) 2019/2015 regulation, Eco design Eco design compliant.
- Apply high efficiency solution, available to get to D rank.
- Mini cutting design, suitable for cutting in various length.
- Ideal for office, residential, retail and industry lighting.

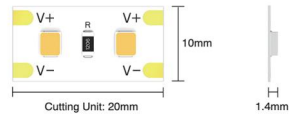

Basic Parameters

Power	15W/m
Input Voltage	12VDC
Input Current	1.08A/m
Cutting Unit	2LEDs/20mm
Size	5000×10×1.4mm
Bend Diameter	> 60mm
Copper foil	3oz

Luminous Intensity Distribution

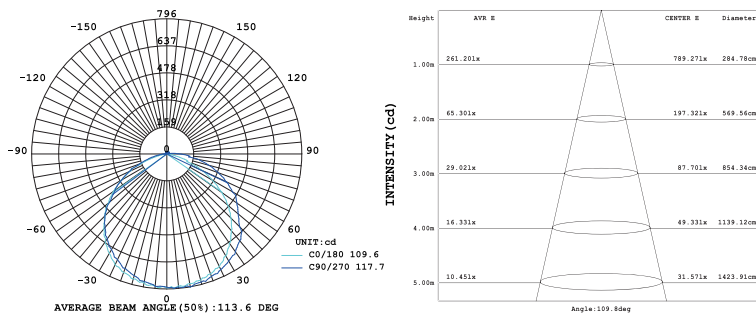

Photo-electric Parameters

CRI	CCT (°K)	LM/M	LM/W	Energy Efficiency CLASS
>80	2700K	2428	161	D
	3000K	2428	161	D
	4000K	2547	170	D
	6000K	2547	170	D

Recommended Accessories

Image			
Code	2PIN-18AWG	V1+R6-1	LRS-100-24

**30 MC2835-24V-200D-10-20**

2835 200LEDS/M 20MM Cut

- 4 leds per cut, only 20mm, ideal for DIY.
- Pass (EU) 2019/2015 regulation, Eco design compliant.
- Apply high efficiency solution, available to get to D rank.
- Mini cutting design, suitable for cutting in various length.
- Ideal for office, residential, retail and industry lighting.

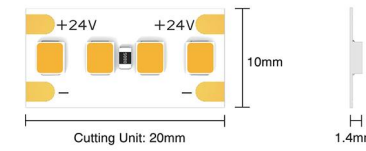

Basic Parameters

Power	20W/m
Input Voltage	24VDC
Input Current	0.833A/m
Cutting Unit	4LEDs/20mm
Size	5000×10×1.4mm
Bend Diameter	> 60mm
Copper foil	3oz

Luminous Intensity Distribution

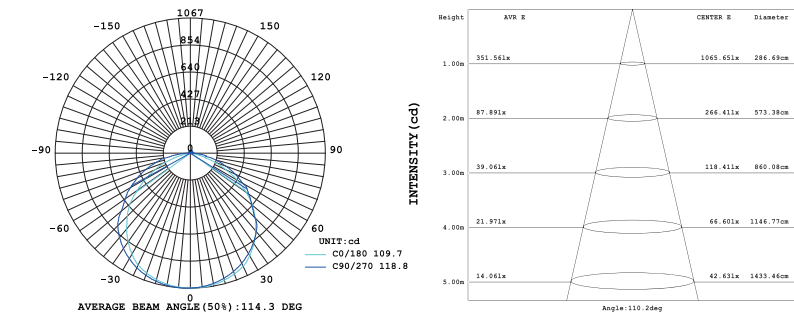

Photo-electric Parameters

CRI	CCT (°K)	LM/M	LM/W	Energy Efficiency CLASS
>80	2700K	3080	154	D
	3000K	3080	154	D
	4000K	3220	161	D
	6000K	3220	161	D

Recommended Accessories

Image			
Code	2PIN-18AWG	V1+R6-1	LRS-150-24

**31 MC2835-24V-160D-5-20**

2835 160LEDS/M 12.5MM cut

- 2 leds per cut, only 12.5mm, ideal for DIY.
- Pass (EU) 2019/2015 regulation, Eco design compliant.
- Apply high efficiency solution, available to get to D rank.
- Mini cutting design, suitable for cutting in various length.
- Ideal for office, residential, retail and industry lighting.

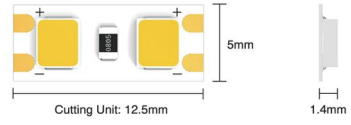

MINI Pass ERP DIY IP54 IP65 IP67 IP68 24V 5mm Width 5M REEL

**Basic Parameters**

Power	10W/m
Input Voltage	24VDC
Input Current	0.417A/m
Cutting Unit	2LEDs/12.5mm
Size	5000×5×1.4mm
Bend Diameter	>60mm
Copper foil	3oz

**Luminous Intensity Distribution**

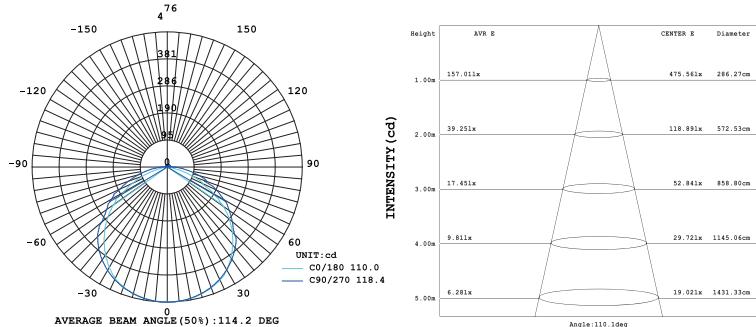

**Photo-electric Parameters**

CRI	CCT (°K)	LM/M	LM/W	Energy Efficiency CLASS
>80	2700K	1470	147	D
	3000K	1470	147	D
	4000K	1540	154	D
	6000K	1540	154	D

**Recommended Accessories**

Image			
Code	2PIN-22AWG	V1+R6-1	LRS-75-24

**32 MC2835-24V-224D-10-20**

2835 224LEDS/M 9MM cut

- 2 leds per cut, only 9mm, ideal for DIY.
- Dual color adjustable 2700+6500K.
- Mini cutting design, suitable for cutting in various length.
- Ideal for office, residential, retail and industry lighting.

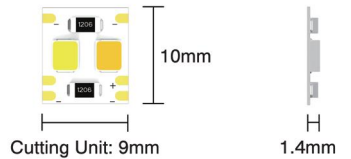

MINI DIY IP54 IP65 IP67 IP68 24V 10mm Width 5M REEL

**Basic Parameters**

Power	18W/m
Input Voltage	24VDC
Input Current	0.75A/m
Cutting Unit	2LEDs/9mm
Size	5000×10×1.4mm
Bend Diameter	>60mm
Copper foil	2oz

**Luminous Intensity Distribution**

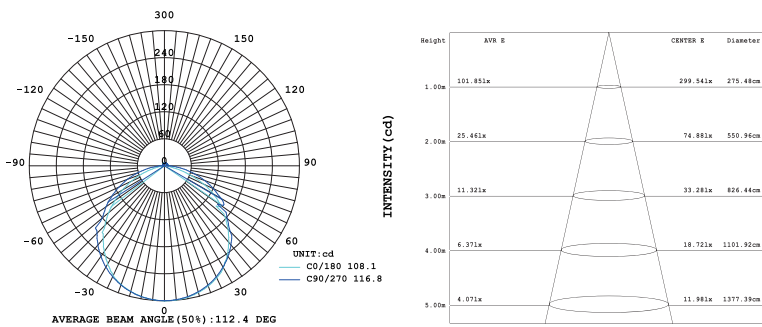

**Photo-electric Parameters**

CRI	CCT (°K)	LM/M	LM/W	Energy Efficiency CLASS
>80	2700K	927	103	/
	4000K	1926	107	/
	6000K	1035	115	/

**Recommended Accessories**

Image			
Code	3PIN-20AWG	V2+R7	LRS-150-24



# Khun High density Series

Linear emitting performance, dots free  
High Density LED Strips

Ultra high density, 300LEDs/m&700LEDs/m.

Cut length 10mm&20mm.

Smallest size of LED, high reliability, excellent anti-bending ability.

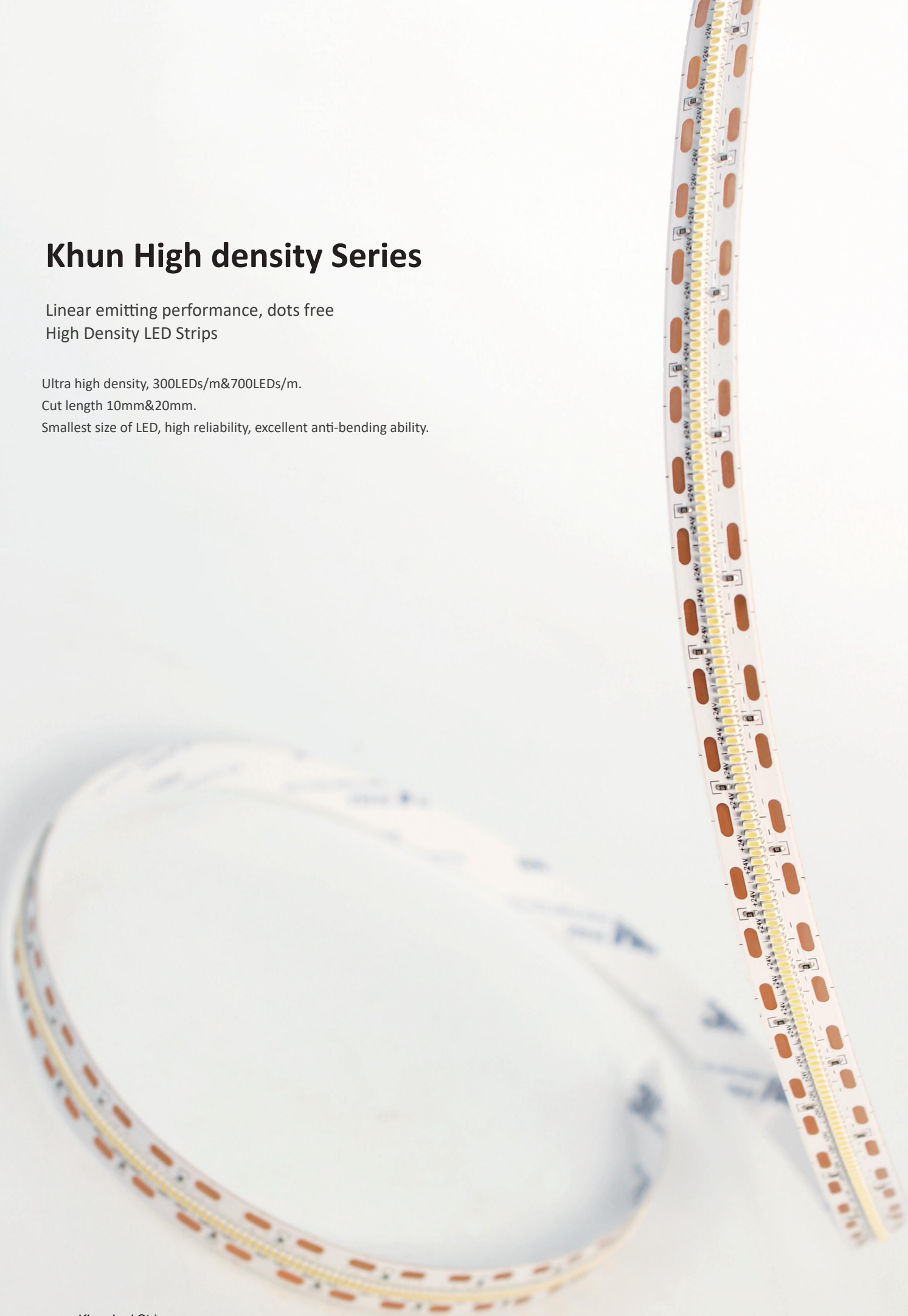

## 33 HD2216-24V-300D-10-20

2216 300LEDs/M

- Super high density with great linear effect.
- Source by more cost-effective SMD2216 Plus with uniform illumination.
- Mini size of LEDs but with strong body.
- Better anti-bending and anti-breaking.
- Standard is CRI>90, CRI95+, Full Spectrum optional.

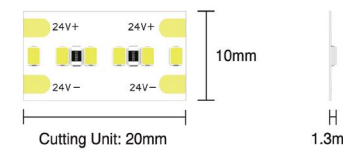

20mm CUT CRI 90 IP54 IP65 IP67 IP68 24V 10mm Width 5M REEL

### Basic Parameters

Power	24W/m
Input Voltage	24VDC
Input Current	1A/m
Cutting Unit	6LEDs/20mm
Size	5000×10×1.3mm
Bend Diameter	>60mm
Copper foil	3oz

### Luminous Intensity Distribution

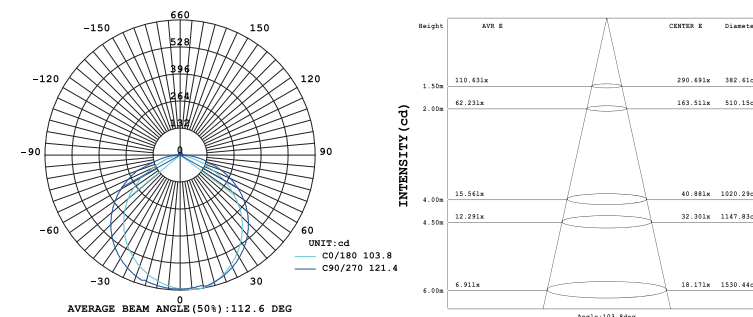

### Photo-electric Parameters

CRI	CCT (°K)	LM/M	LM/W	Energy Efficiency CLASS
>90	2700K	1680	70	/
	3000K	1680	70	/
	4000K	1800	75	/
	6000K	1800	75	/

### Recommended Accessories

Image			
Code	2PIN-18AWG	V1+R6-1	LRS-150-24

**34 HD2110-24V-700D-12-20**

2110 700LEDS/M

- Super high density with great linear effect.
- Source by high quality 2110 LED with uniform illumination.
- Mini size of LEDs but with strong body.
- Standard is CRI>90, CRI95+, Full Spectrum optional.

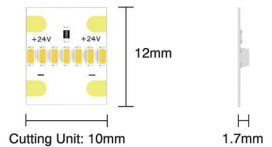

10mm CUT CRI 90 IP54 IP65 IP67 IP68 24V Width 12mm 5M REEL

**Basic Parameters**

Power	24W/m
Input Voltage	24VDC
Input Current	1A/m
Cutting Unit	7LEDs/10mm
Size	5000×12×1.7mm
Bend Diameter	>60mm
Copper foil	3oz

**Luminous Intensity Distribution**

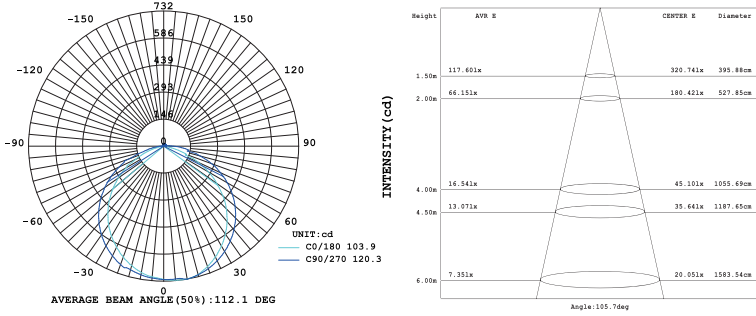

**Photo-electric Parameters**

CRI	CCT (°K)	LM/M	LM/W	Energy Efficiency CLASS
>90	2700K	2016	84	/
	3000K	2016	84	/
	4000K	2136	89	/
	6000K	2136	89	/

**Recommended Accessories**

Image			
Code	2PIN-18AWG	V1+R6-1	LRS-150-24

**35 HD2022-24V-320D-10-20**

2022 320LEDS/M

- High CRI >90, and CRI95+ are available.
- Cuttable and Re-Connectable, with Various Connector.
- Pass New EU (2019/2015) regulation, Eco design conformed.
- High Brightness, Efficiency, Customized Wattage, Cost effective.
- Source by New & high output 2022 Top Led with uniform illumination.

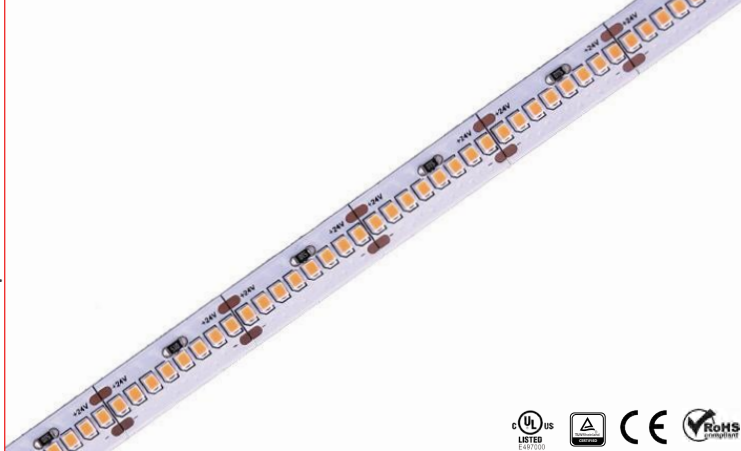
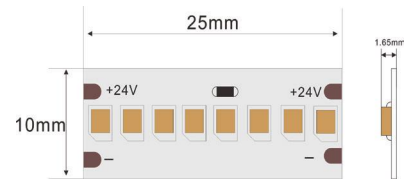

25mm CUT Pass ERP CRI 90 IP54 IP65 IP67 IP68 24V Width 10mm 5M REEL

**Basic Parameters**

Power	24W/m
Input Voltage	24VDC
Input Current	1A/m
Cutting Unit	8LEDs/25mm
Size	5000×10×1.65mm
Bend Diameter	>60mm
Copper foil	3oz

**Luminous Intensity Distribution**

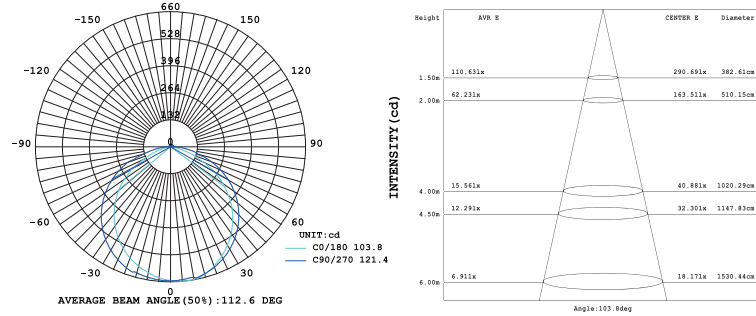

**Photo-electric Parameters**

CRI	CCT (°K)	LM/M	LM/W	Energy Efficiency CLASS
>90	2700K	2544	106	F
	3000K	2544	106	F
	4000K	2640	110	F
	6000K	2640	110	F

**Recommended Accessories**

Image			
Code	2PIN-18AWG	V1+R6-1	LRS-150-24



## 36 HB5730-24V-160D-10-20

5730 160LEDS/M

- High brightness LED 5730.
- Apply 8LEDs per segment high efficiency solution.
- Big size LED with wider illuminating surface.
- Standard is CRI>80, CRI90+, 95+ are available.
- Pass (EU) 2019/2015 regulation.

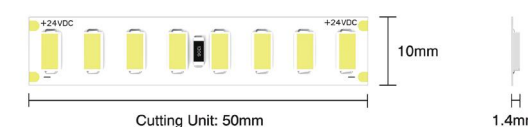

### Basic Parameters

Power	24W/m
Input Voltage	24VDC
Input Current	1A/m
Cutting Unit	8LEDs/50mm
Size	5000×10×1.4mm
Bend Diameter	> 60mm
Copper foil	3oz

### Luminous Intensity Distribution

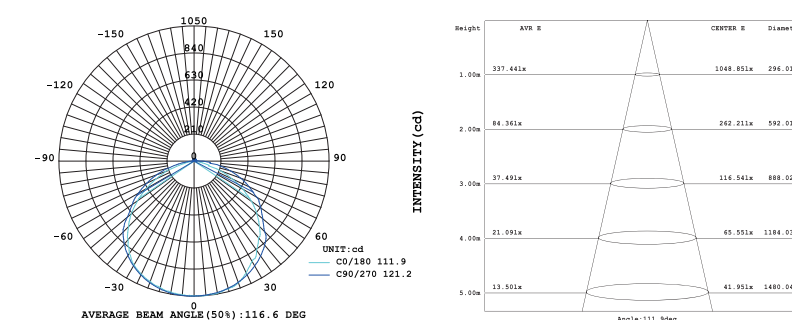

### Photo-electric Parameters

CRI	CCT (°K)	LM/M	LM/W	Energy Efficiency CLASS
>80	2700K	3144	131	E
	3000K	3144	131	E
	4000K	3312	138	E
	6000K	3312	138	E

### Recommended Accessories

Image	Code
	2PIN-18AWG
	V1+R6-1
	LRS-150-24

## Khun High brightness Series

Source by high output LED with uniform illumination High brightness LED Strips

Pass (EU) 2019/2015 regulation, Eco design compliant.  
High brightness, high efficiency, customized wattage, luminous flux per M.



# HIGH BRIGHTNESS SERIES

## 37 HB2835-24V-480D-15-20

2835 150lm/W 480LEDS/M

- High brightness LED 2835.
- Apply 16LEDs per segment high efficiency solution.
- Double row LEDs with uniform light distribution.
- Standard is CRI>80, CRI90+, 95+ are available.
- Pass (EU) 2019/2015 regulation.

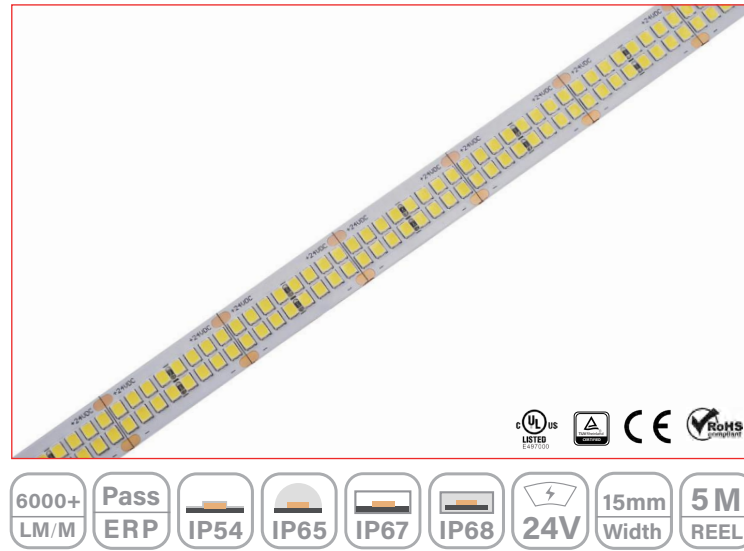
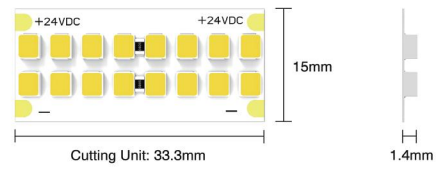

### Basic Parameters

Power	40W/m
Input Voltage	24VDC
Input Current	1.667A/m
Cutting Unit	16LEDs/33.3mm
Size	5000×15×1.4mm
Bend Diameter	>60mm
Copper foil	3oz

### Luminous Intensity Distribution

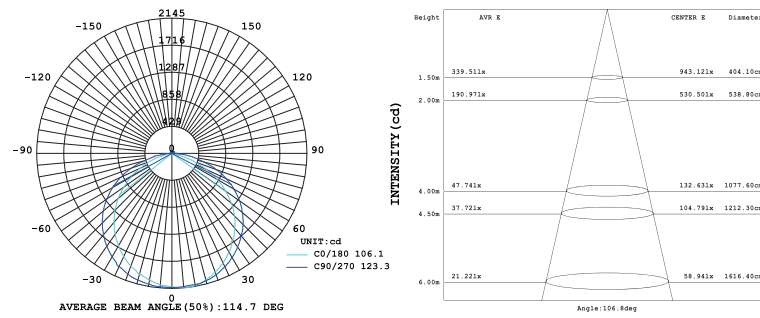

CRI	CCT (°K)	LM/M	LM/W	Energy Efficiency CLASS
>80	2700K	5800	145	E
	3000K	5800	145	E
	4000K	6160	154	D
	6000K	6160	154	D

### Recommended Accessories

Image	Code
	2PIN-18AWG
	V1+R6-1
	LRS-250-24

## CCT Series

More CCT optional  
CCT LED Strips

- Three-wire adjustable toning strip makes it widely match all kinds of controllers.
- Dim to warm strip, two pole control, widely adapted with PWM controllers.
- CRI90+/95+/FS optional.
- Widely adapted with normal switch & power supply.



**38 CA2835-24V-224D-12-20**

2835 224LEDS/M

- Dual color adjustable, tunable white 2700K-6500K.
- Pass (EU) 2019/2015 regulation.
- Source by high output 2835 Led with uniform illumination.
- Standard is CRI >80; CRI90+, CRI95+ are optional.
- High Brightness, Efficiency, Customized wattage, Luminous Flux per M.



Dual Color
Pass ERP
IP54
IP65
IP67
IP68
24V
12mm Width
5M REEL

Basic Parameters

Power	21W/m
Input Voltage	24VDC
Input Current	0.875A/m
Cutting Unit	16LEDs/71.5mm
Size	5000×12×1.3mm
Bend Diameter	>60mm
Copper foil	3oz

Luminous Intensity Distribution

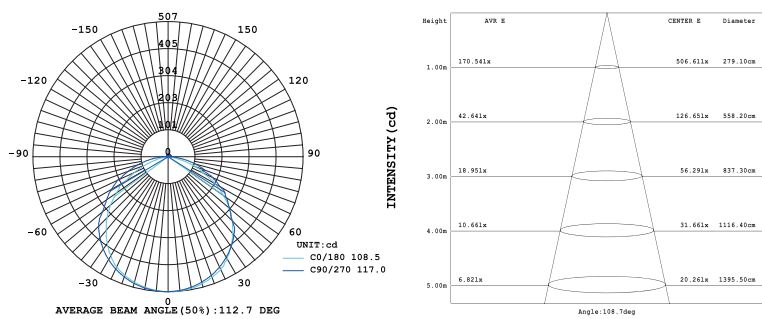

CRI	CCT (°K)	LM/M	LM/W	Energy Efficiency CLASS
>80	2700K	1449	138	E
	4000K	2919	139	E
	6000K	1491	142	E

Recommended Accessories

Image			
Code	3PIN-20AWG	V2+R7-1	LRS-150-24

**39 CA2216-24V-288D-10-20**

2216 288LEDS/M

- Dual color adjustable, tunable white 2700K-6500K.
- Source by more cost-effective SMD2216 Plus with uniform illumination.
- Mini size of LEDs but with strong body.
- Standard is CRI >90, CRI95+ optional.
- Customized wattage, Luminous Flux per M.

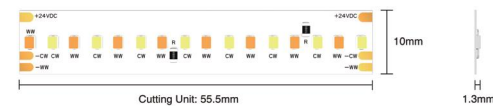

Dual Color
CRI 90
IP54
IP65
IP67
IP68
24V
10mm Width
5M REEL

Basic Parameters

Power	22W/m
Input Voltage	24VDC
Input Current	0.917A/m
Cutting Unit	16LEDs/55.5mm
Size	5000×10×1.3mm
Bend Diameter	>60mm
Copper foil	3oz

Luminous Intensity Distribution

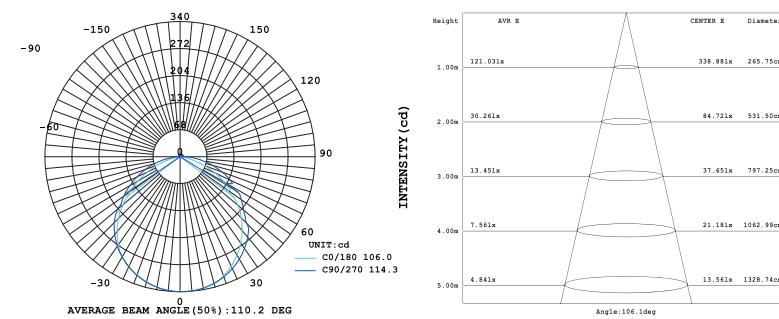

CRI	CCT (°K)	LM/M	LM/W	Energy Efficiency CLASS
>90	2700K	957	87	/
	4000K	2134	97	/
	6000K	1177	107	/

Recommended Accessories

Image			
Code	3PIN-20AWG	V2+R7-1	LRS-150-24

**40 DTW2835-24V-168D-10-20**

2835 168LEDS/M 1800K-4000K

- Widely adapted with PWM controllers.
- Dim to warm, tunable white 1800K-4000K.
- Two pole control, led 1800K+6500K design.
- Standard is CRI >80; CRI90+, CRI95+ are optional.
- Source by high output 2835 Led with uniform illumination.

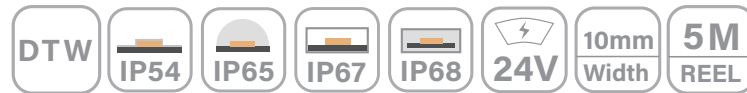
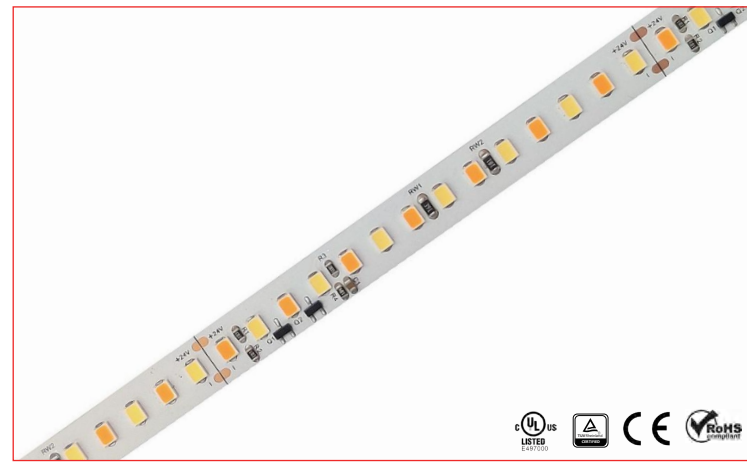
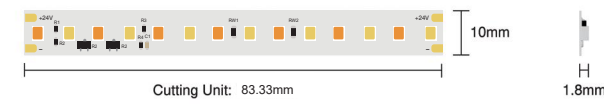

Basic Parameters

Power	10W/m
Input Voltage	24VDC
Input Current	0.414A/m
Cutting Unit	14LEDs/83.33mm
Size	5000×10×1.8mm
Bend Diameter	>60mm
Copper foil	2oz

Luminous Intensity Distribution

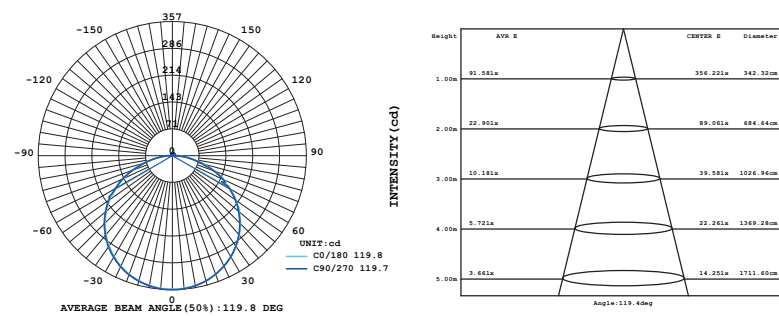

CRI	CCT (°K)	LM/M	LM/W	Energy Efficiency CLASS
>80	1800K-4000K	1064	107	/
>90	1800K-4000K	1104	104	/

Recommended Accessories

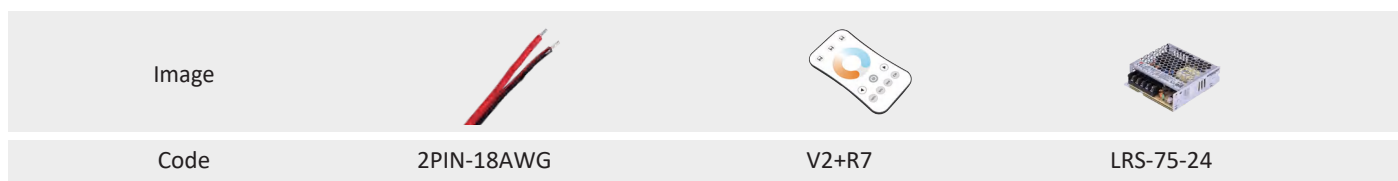

**41 DTW2216-24V-264D-10-20**

2216 264LEDS/M 1800K-4000K

- Dim to warm, tunable white 1800K-4000K.
- Two pole control, led 1800K+6500K design.
- Source by more cost-effective SMD2216 Plus with uniform illumination.
- Widely adapted with PWM controllers.
- Standard is CRI>90, CRI95+ optional.

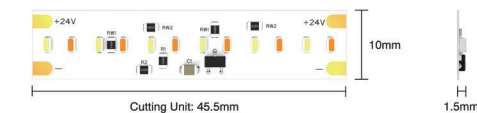

Basic Parameters

Power	18W/m
Input Voltage	24VDC
Input Current	0.7844A/m
Cutting Unit	12LEDs/45.5mm
Size	5000×10×1.5mm
Bend Diameter	>60mm
Copper foil	3oz

Luminous Intensity Distribution

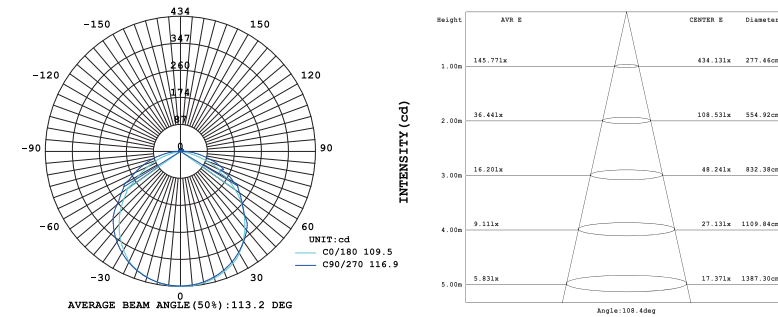

CRI	CCT (°K)	LM/M	LM/W	Energy Efficiency CLASS
>90	1800K-4000K	1543	82	/

Recommended Accessories

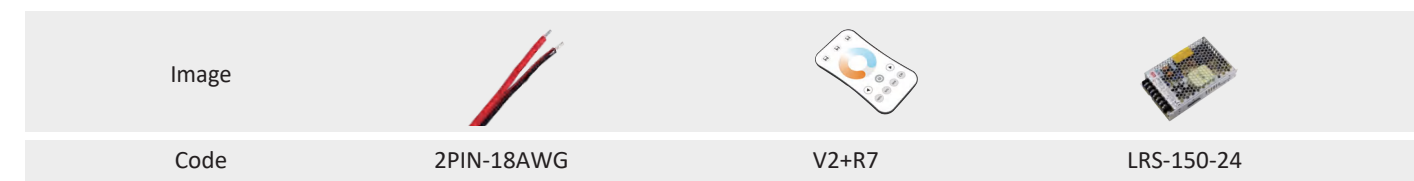



# CCT SERIES

42

## CA2022-24V-280D-10-20

2022 280LEDS/M

- CCT adjustable with 3000K~6500K.
- Cost-effective solutions with better prices.
- Pass New EU (2019/2015) regulation, Eco design conformed.
- High Brightness, Efficiency, Customized Wattage, Cost Effective.
- Source by New & high output 2022 Top Led with uniform illumination.

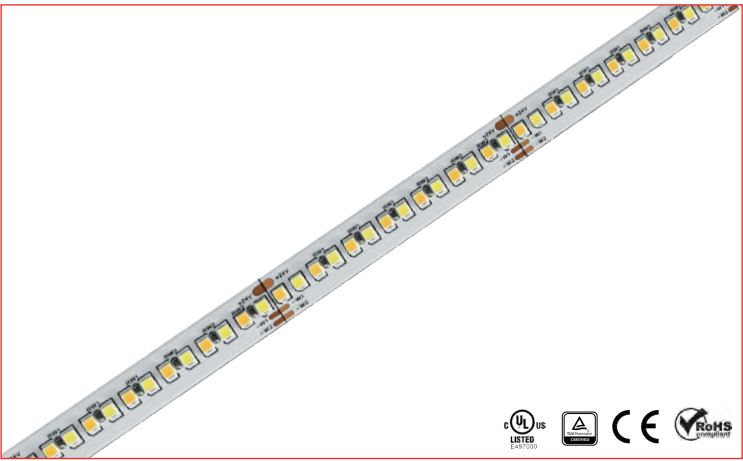

Dual Color
CRI 90
IP54
IP65
IP67
IP68
24V
10mm Width
5M REEL

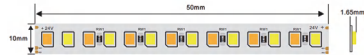

### Basic Parameters

Power	22W/m
Input Voltage	24VDC
Input Current	0.935A/m
Cutting Unit	14LEDs/50mm
Size	5000×10×1.65mm
Bend Diameter	>60mm
Copper foil	3oz

### Luminous Intensity Distribution

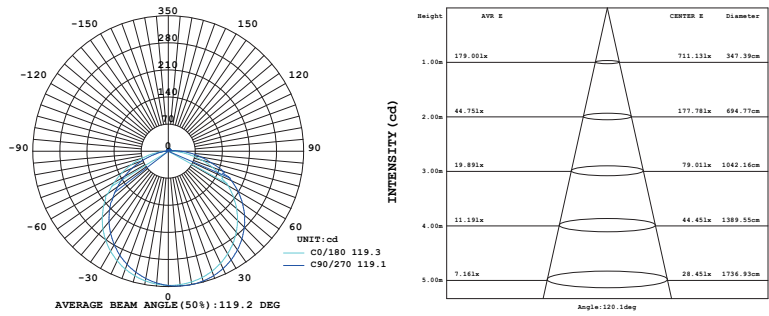

CRI	CCT (°K)	LM/M	LM/W	Energy Efficiency CLASS
>90	3000K	1139	102	/
	4500K	2363	105	F
	6500K	1221	108	/

### Recommended Accessories

Image			
Code	3PIN-20AWG	V2+R7	LRS-150-24



# Side-emitting Series

Apply 3014 as light source  
Side Emitting LED Strips

Higher anti-bending performance of reliability.  
Widely used in advertising, decoration and other scenes.



# SIDE-EMITTING SERIES

## 43 SE3014-24V-120D-8-20

3014 120LEDS/M

- Side emitting led strip light.
- Apply 3014 as light source, high efficiency than 335 & 315 LEDs.
- Suitable use for advertising signage, text art and ballot.
- CCT optional between 2700K-10000K.

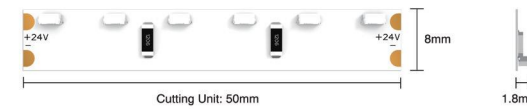

SE IP54 IP67 24V 8mm 5M REEL

### Basic Parameters

Power	9.6W/m
Input Voltage	24VDC
Input Current	0.40A/m
Cutting Unit	6LEDs/50mm
Size	5000×8×1.8mm
Bend Diameter	> 60mm
Copper foil	2oz

### Luminous Intensity Distribution

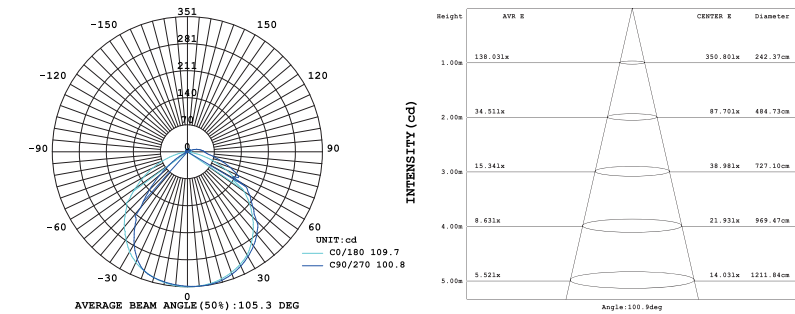

CRI	CCT (°K)	LM/M	LM/W	Energy Efficiency CLASS
>80	2700K	941	98	/
	3000K	941	98	/
	4000K	1008	105	F
	6000K	1008	105	F

### Recommended Accessories

Image	Code
	2PIN-18AWG
	V1+R6-1
	LRS-75-24



# Khun S Shape Series

Special S type PCB design, bendable in every way  
S Shape LED Strips

Can be twisted and bent arbitrary to solve the circuit damage problem.  
Improve the product flexibility.

Suitable use for advertising signage, text art and so on  
10 optional 2700K\3000K\4000K\6500K\R\G\B\Y\RGB\RGBW.



# S SHAPE SERIES

## 44 HE2835-12V-64D-6-20

2835 64LEDS/M

- Special S type PCB design, bendable in every way.
- 4LEDs/segment, high efficiency solution available to get to D rank.
- Pass (EU) 2019/2015, Eco design compliant.
- Suitable use for advertising signage, text art and ballot.
- CCT optional between 1800K-10000K.

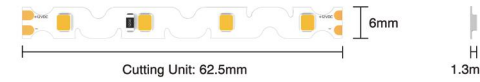

S TYPE
160 LM/W
150 LM/W
IP54
12V
6 mm
5M REEL

### Basic Parameters

Power	4.8W/m
Input Voltage	12VDC
Input Current	0.40A/m
Cutting Unit	4LEDs/62.5mm
Size	5000×6×1.3mm
Bend Diameter	>60mm
Copper foil	2oz

### Luminous Intensity Distribution

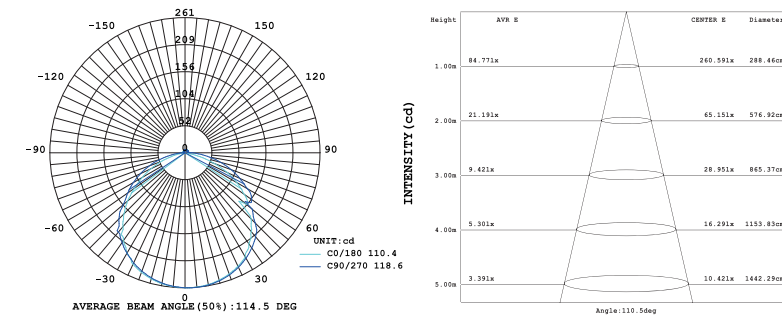

CRI	CCT (°K)	LM/M	LM/W	Energy Efficiency CLASS
>80	2700K	734	153	D
	3000K	734	153	D
	4000K	792	165	D
	6000K	792	165	D

### Recommended Accessories

Image	Code
	2PIN-20AWG
	V1+R6-1
	LRS-35-12



## 45 S2835-12V-60D-6-20

2835 60LEDS/M

- Special S type PCB design, bendable in every way.
- 3LEDs/segment, can be cut according to the printing mark.
- Pass (EU) 2019/2015 regulation, Eco design compliant.
- Suitable use for advertising signage, text art and ballot.
- CCT optional between 1800K-10000K.

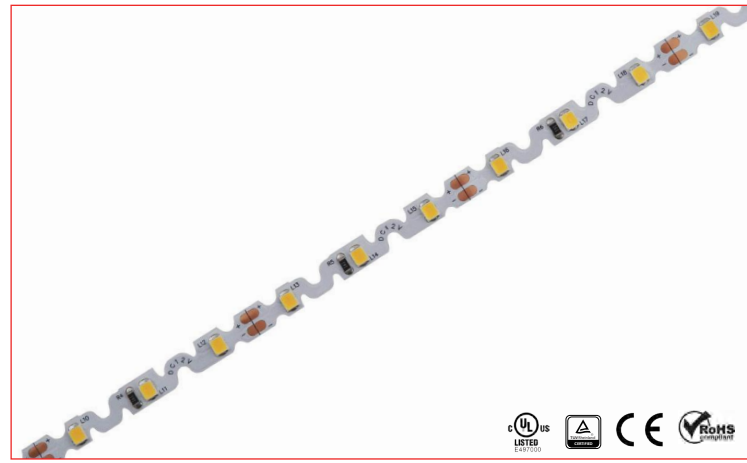
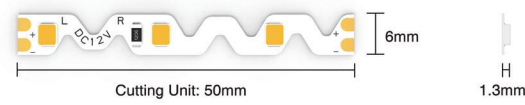

### Basic Parameters

Power	4.8W/m
Input Voltage	12VDC
Input Current	0.40A/m
Cutting Unit	3LEDs/50mm
Size	5000×6×1.3mm
Bend Diameter	>60mm
Copper foil	2oz

### Luminous Intensity Distribution

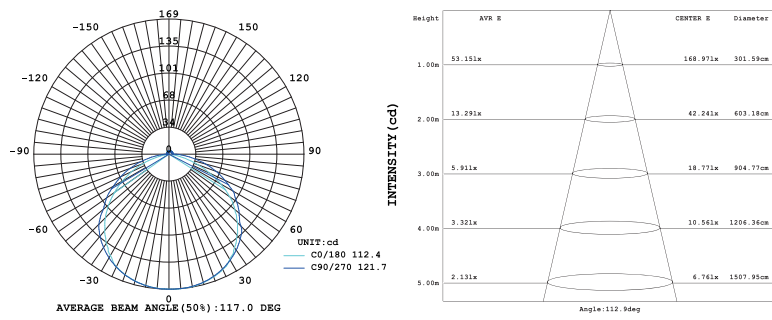

CRI	CCT (°K)	LM/M	LM/W	Energy Efficiency CLASS
>80	2700K	509	106	F
	3000K	509	106	F
	4000K	537	112	F
	6000K	537	112	F

### Recommended Accessories

Image			
Code	2PIN-20AWG	V1+R6-1	LRS-35-12

## 46 SRGB5050-12V-48D-8-20

5050 48LEDS/M

- Special S type PCB design, bendable in every way.
- 3LEDs/segment, can be cut according to the printing mark.
- Apply top 5050 RGB LEDs, stable and high brightness.
- Suitable use for advertising signage, text art and ballot.

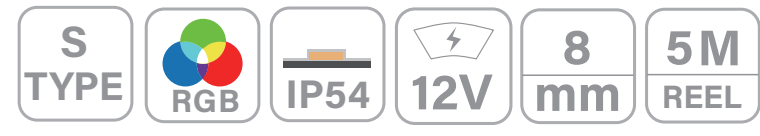

### Basic Parameters

Power	7.2W/m
Input Voltage	12VDC
Input Current	0.60A/m
Cutting Unit	3LEDs/62.5mm
Size	5000×8×2.1mm
Bend Diameter	>60mm
Copper foil	2oz

### Luminous Intensity Distribution

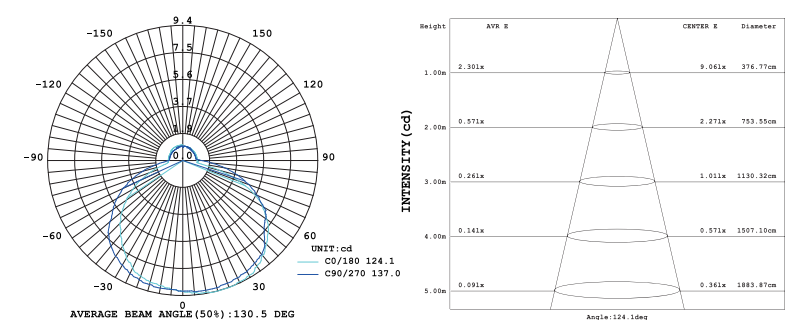

COLOR	LM/M	LM/W
RGB	266	37

### Recommended Accessories

Image			
Code	4PIN-22AWG	V3+R8-1	LRS-50-12

# S SHAPE SERIES

## 47 SHE2835-24V-128D-6-20

2835 128LEDS/M

- Special S type PCB design, bendable in every way.
- 8LEDs/segment, high efficiency solution available to get to D rank.
- Pass (EU) 2019/2015, Eco design compliant.
- Suitable use for advertising signage, text art and ballot.
- CCT optional between 1800K-10000K.

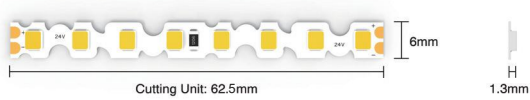

S TYPE
160 LM/W
150 LM/W
IP54
24V
6 mm
5M REEL

### Basic Parameters

Power	10W/m
Input Voltage	24VDC
Input Current	0.416A/m
Cutting Unit	8LEDs/62.5mm
Size	5000x6x1.3mm
Bend Diameter	> 60mm
Copper foil	2oz

### Luminous Intensity Distribution

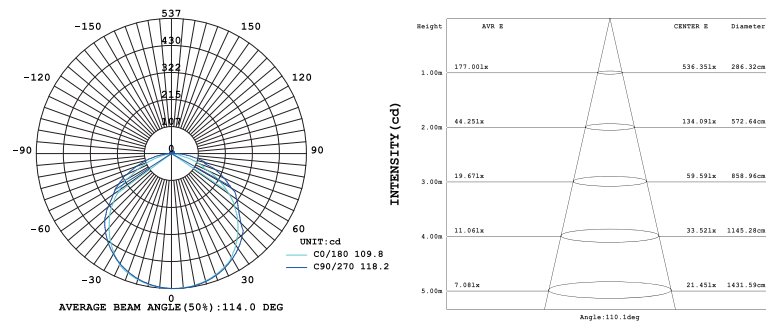

### Photo-electric Parameters

CRI	CCT (°K)	LM/M	LM/W	Energy Efficiency CLASS
>80	2700K	1510	151	D
	3000K	1510	151	D
	4000K	1590	159	D
	6000K	1590	159	D

### Recommended Accessories

Image	Code
	2PIN-22AWG
	V1+R6-1
	LRS-75-24

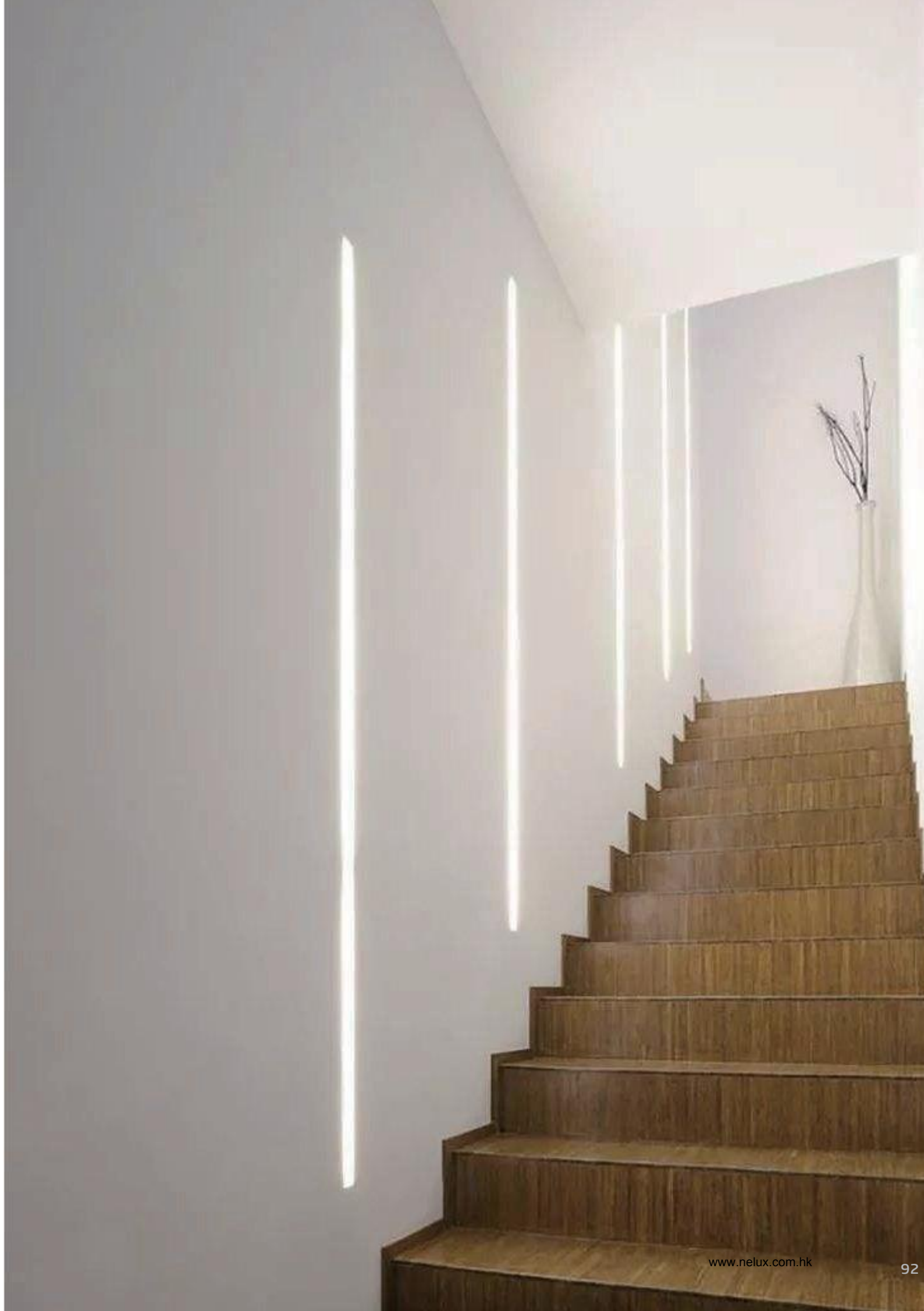





# Khun Lens Series

2835 Beam angle optional with 15°/15°-20°/20°/30°/60°/15°\*45°.

5050 Beam angle optional with 30°/15°\*45°.

Dust and waterproof level: IP67, anti-UV.

High light effect, fast cooling and uniform light, longer life.

Ideal for outdoor & advertising & interior & atmosphere decoration lighting.

## 48 WW2835MC-24V-48D-20-67

2835 48LEDS/M

- High-power 2835 chip, high light effect, fast cooling and uniform light, longer life.
- Pass EU 2019/2015 regulation, and Eco design compliant.
- Flexible design is suitable for a variety of shapes of bend.
- Dust and waterproof level: IP67, anti-UV.
- Beam angle optional with 15°/15°-20°/20°/30°/60°/15°\*45°.
- Ideal for outdoor & advertising & interior & atmosphere decoration lighting.

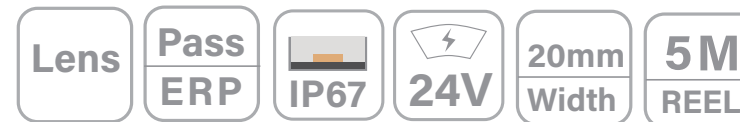

### Basic Parameters

Power	14W/m
Input Voltage	24VDC
Input Current	0.583A/m
Cutting Unit	1LEDs/20.82mm
Size	5000×20×11.3mm
Bend Diameter	>60mm
Copper foil	2oz

### Luminous Intensity Distribution

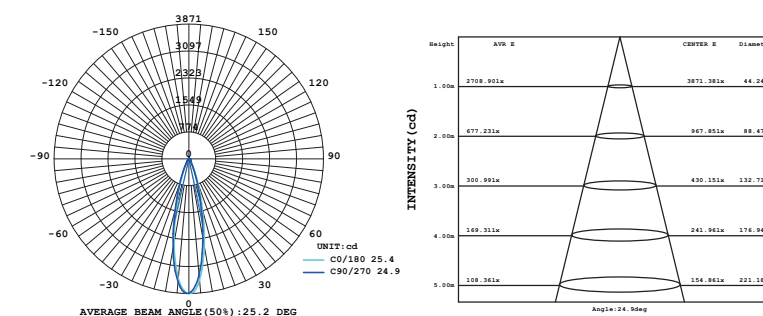

### Photo-electric Parameters

CRI	CCT (°K)	LM/M	LM/W	Energy Efficiency CLASS
>90	2700K	1131	81	F
	3000K	1131	81	F
	4000K	1187	85	F
	6500K	1187	85	F

### Recommended Accessories

Image		
Code	V1+R6-1	LRS-100-24



**49 WW2835-24V-48D-20-67**

2835 48LEDS/M

- Khun High-power 2835 chip, high light effect, fast cooling and uniform light, longer life.
- Pass EU 2019/2015 regulation, Eco design compliant.
- Flexible design is suitable for a variety of shapes of bend.
- Dust and waterproof level: IP65, anti-UV.
- Beam angle optional with 15°/15°-20°/20°/30°/60°/15°\*45°.
- Ideal for outdoor & advertising & interior & atmosphere decoration lighting.



Lens Pass ERP IP67 24V 20mm Width 5M REEL

Luminous Intensity Distribution

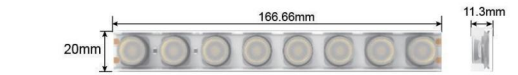
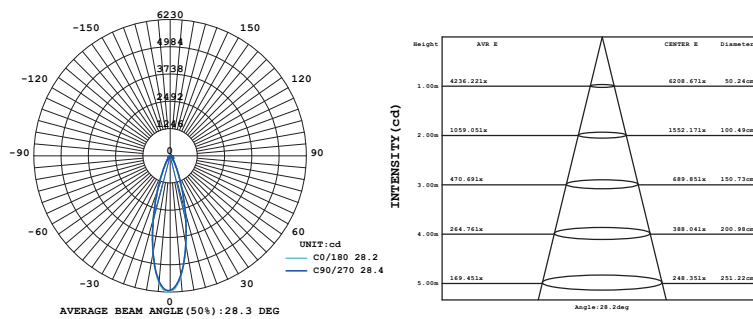

Basic Parameters

Power	18W/m
Input Voltage	24VDC
Input Current	0.7174A/m
Cutting Unit	8LEDs/166.66mm
Size	5000×20×11.3mm
Bend Diameter	>60mm
Copper foil	2oz

Photo-electric Parameters

CRI	CCT (°K)	LM/M	LM/W	Energy Efficiency CLASS
>90	2700K	2350	131	D
	3000K	2350	131	D
	4000K	2368	138	D
	6000K	2368	138	D

Recommended Accessories

Image		
Code	V1+R6-1	LRS-150-24

**50 WW2835CA-24V-42D-20-67**

2835 42LEDS/M

- Khun High-power 2835 chip, high light effect, fast cooling and uniform light, longer life.
- Flexible design is suitable for a variety of shapes of bend.
- Dust and waterproof level: IP67, anti-UV.
- Ideal for outdoor & advertising & interior & atmosphere decoration lighting.
- Dual color 2700K-6500K.



Lens Dual Color IP67 24V 20mm Width 5M REEL

Luminous Intensity Distribution

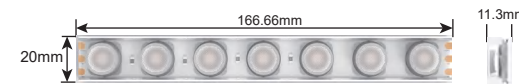
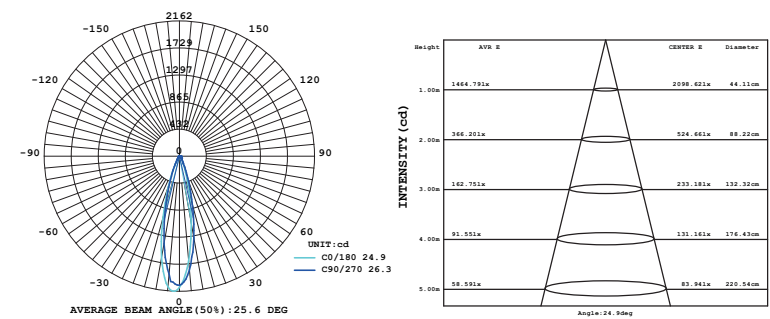

Basic Parameters

Power	16W/m
Input Voltage	24VDC
Input Current	0.6816A/m
Cutting Unit	7LEDs/166.66mm
Size	5000×20×11.3mm
Bend Diameter	>60mm
Copper foil	2oz

Photo-electric Parameters

CRI	CCT (°K)	LM/M	LM/W	Energy Efficiency CLASS
>90	2700K	610	75	G
	4000K	1278	78	F
	6500K	673	83	F

Recommended Accessories

Image		
Code	V2+R7-1	LRS-100-24

**51 WW2835CC-24V-36D-20-67**

2835 36LEDS/M

- 15M long strip driven by one end, 30M long strip driven by two ends power supply, with same brightness from front to end.
- Source by Top 2835 LEDs, and IC for constant current.
- High light effect, fast cooling and uniform light, longer life.
- Flexible design is suitable for a variety of shapes of bend.
- Dust and waterproof level: IP67, anti-UV.
- Ideal for outdoor & advertising & interior & atmosphere decoration lighting.

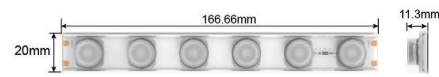

**NEW**

Lens Run 30M IP67 24V 20mm Width 5M REEL

Basic Parameters

Power	12W/m
Input Voltage	24VDC
Input Current	0.5122A/m
Cutting Unit	6LEDs/166.66mm
Size	5000×20×11.3mm
Bend Diameter	> 60mm
Copper foil	2oz

Luminous Intensity Distribution

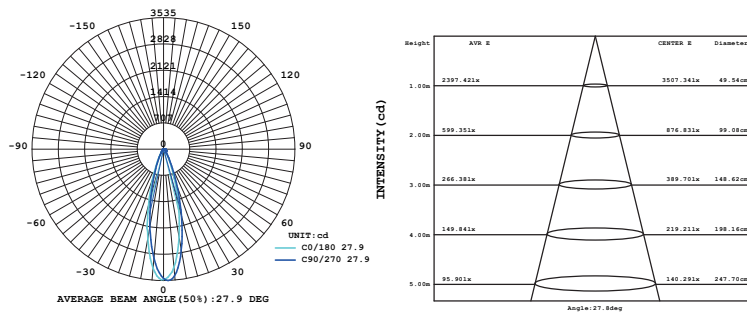

Photo-electric Parameters

CRI	CCT (°K)	LM/M	LM/W	Energy Efficiency CLASS
>80	2700K	1308	109	E
	3500K	1308	109	E
	4000K	1368	114	E
	6500K	1368	114	E

Recommended Accessories

Image		
Code	V1+R6-1	LRS-75-24

**52 WW5050RGB-24V-42D-20-67**

5050 42LEDS/M

- High-power 5050 chip, high light effect, fast cooling and uniform light, longer life.
- Flexible design is suitable for a variety of shapes of bend.
- Diffuse reflective led strip with 30°/15°\*45°.
- Ideal for backlight decoration use.

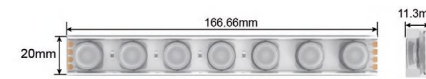

**NEW**

Lens RGB IP67 24V 20mm Width 5M REEL

Basic Parameters

Power	12W/m
Input Voltage	24VDC
Input Current	0.5234A/m
Cutting Unit	7LEDs/166.66mm
Size	5000×20×11.3mm
Bend Diameter	> 60mm
Copper foil	2oz

Luminous Intensity Distribution

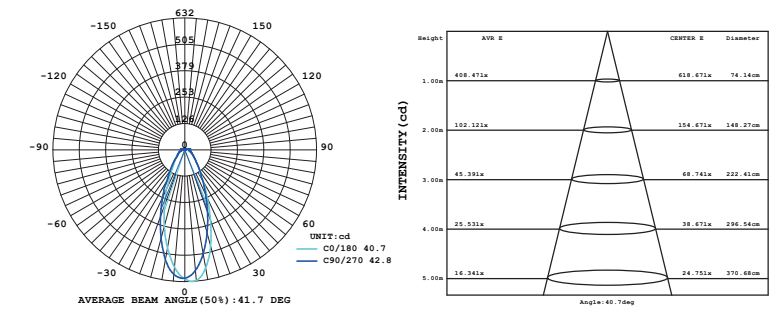

Photo-electric Parameters

COLOR	LM/M	LM/W
RGB	662	53

Recommended Accessories

Image		
Code	V3+R8-1	LRS-75-24

**53 WW5050RGBW-24V-42D-20-67**

5050 42LEDS/M

- High-power 5050 chip, high light effect, fast cooling and uniform light, longer life.
- Flexible design is suitable for a variety of shapes of bend.
- Diffuse reflective led strip with 30°/15°\*45°.
- Standard is CRI80, CRI90 is also available.
- Ideal for backlight decoration use.

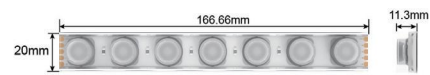

**NEW**



Lens Back light RGB W IP67 24V 20mm Width 5M REEL

**Basic Parameters**

Power	12W/m
Input Voltage	24VDC
Input Current	0.5232A/m
Cutting Unit	7LEDs/166.66mm
Size	5000×20×11.3mm
Bend Diameter	>60mm
Copper foil	2oz

**Luminous Intensity Distribution**

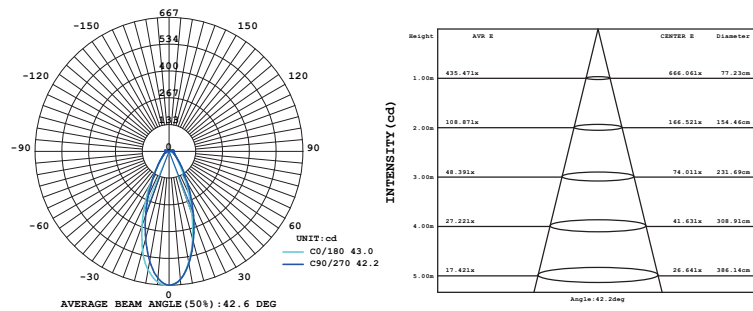

**Photo-electric Parameters**

CRI	CCT (°K)	LM/M	LM/W
>80	RGBW( 2700K)	632	50
	RGBW( 3000K)	632	50
	RGBW( 4000K)	664	53
	RGBW( 6000K)	664	53

**Recommended Accessories**

Image		
Code	VP+R8-1	LRS-75-24

**54 WW5050RGBDMX-24V-36D-20-67**

5050 36LEDS/M

- High light effect, fast cooling and uniform light, longer life.
- Flexible design is suitable for a variety of shapes of bend.
- Dust and waterproof level: IP67, anti-UV.
- Ideal for outdoor & advertising & interior & atmosphere decoration lighting.

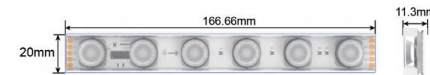

**NEW**



DMX Lens Back light IP67 24V 20mm Width 5M REEL

**Basic Parameters**

Power	12W/m
Input Voltage	24VDC
Input Current	0.5421A/m
Cutting Unit	6LEDs/166.66mm
Size	5000×20×11.3mm
Bend Diameter	>60mm
Copper foil	2oz

**Luminous Intensity Distribution**

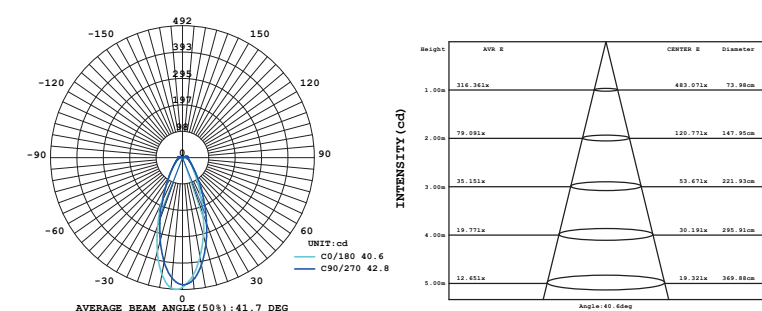

**Photo-electric Parameters**

COLOR	LM/M	LM/W
RGB	520	40

**Recommended Accessories**

Image		
Code	V3+R8-1	LRS-75-24





# Khun Multi-Color Series

RGB/RGBW/RGB+CCT  
Multi-Color LED Strips

High brightness LED chip.  
Widely adaptable to all types of controllers.  
More options for white light.

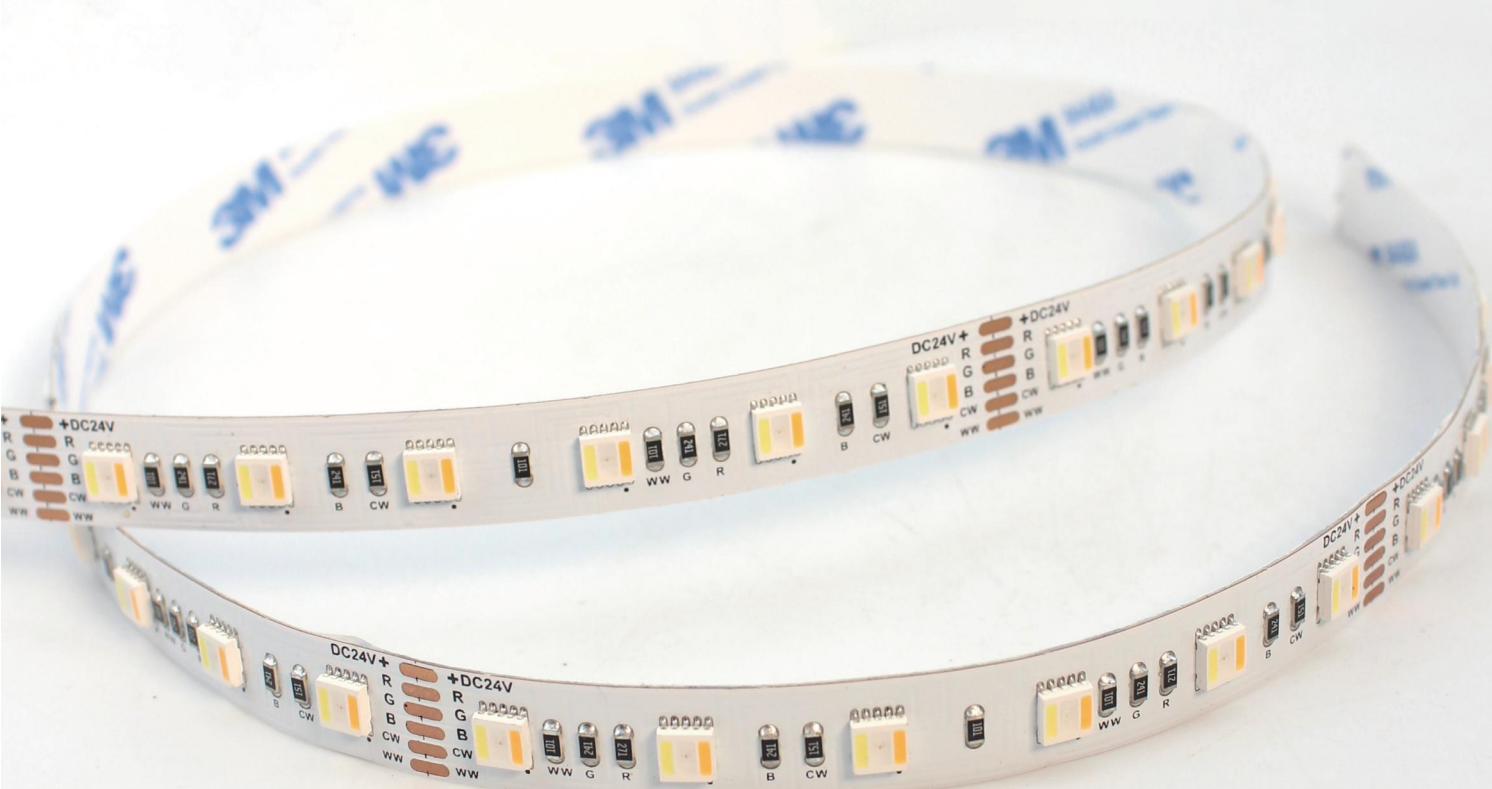

## 55 RGB5050-24V-80D-10-20

5050 80LEDS/M

- 5050 RGB LED as light source, stable and high brightness;
- Compatible with most of RGB controllers in the markets;
- 12V or 24V low voltage input for human safety;
- Ideal for office, residential, retail and industry lighting.

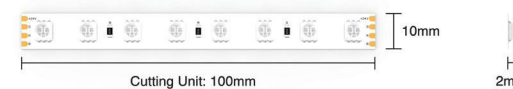

RGB IP54 IP65 IP67 IP68 24V 10mm Width 5M REEL

### Basic Parameters

Power	10W/m
Input Voltage	24VDC
Input Current	0.417A/m
Cutting Unit	8LEDs/100mm
Size	5000×10×2mm
Bend Diameter	>60mm
Copper foil	2oz

### Luminous Intensity Distribution

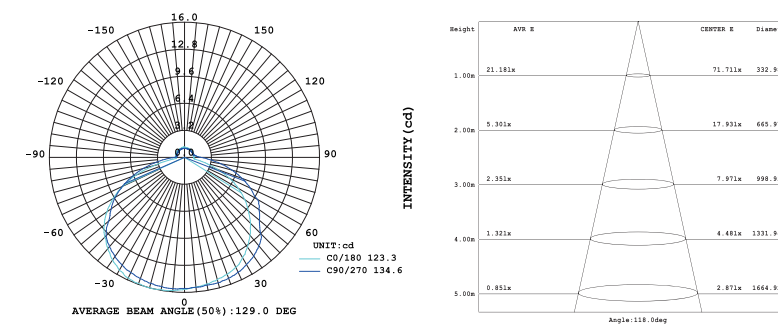

### Photo-electric Parameters

COLOR	LM/M	LM/W
RGB	487	45

### Recommended Accessories

Image	Code
	4PIN-20AWG
	SRW-10BB-4PIN
	V3+R8-1
	LRS-75-24

**56 RGB3838-24V-160D-10-20**

3838 160LEDS/M

- 160leds/m, high density and widely use;
- Apply Top 3838 LED as light source, RGB color changing;
- Compatible with most of RGB controllers in the markets;
- Ideal for office, residential, retail and industry lighting.

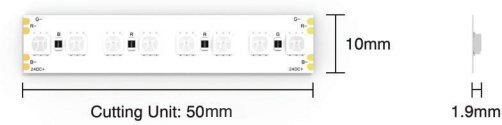

RGB IP54 IP65 IP67 IP68 24V 10mm Width 5M REEL

**Basic Parameters**

Power	16W/m
Input Voltage	24VDC
Input Current	0.687A/m
Cutting Unit	8LEDs/50mm
Size	5000×10×1.9mm
Bend Diameter	>60mm
Copper foil	3oz

**Luminous Intensity Distribution**

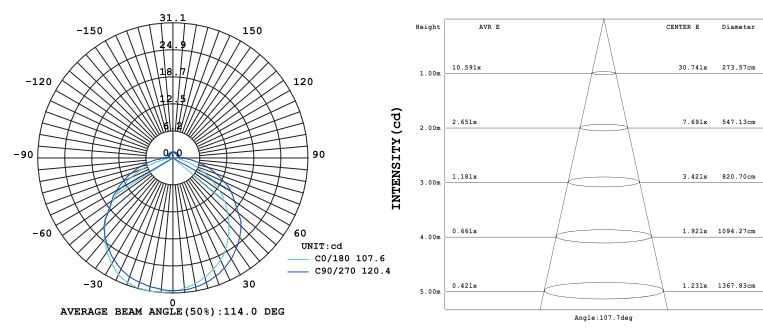

**Photo-electric Parameters**

COLOR	LM/M	LM/W
RGB <span style="color:red">■</span> <span style="color:green">■</span> <span style="color:blue">■</span>	780	49

**Recommended Accessories**

Image			
Code	4PIN-20AWG	V3+R8-1	LRS-100-24

**57 RGBW5050-24V-60D-12-20**

5050 60LEDS/M

- Four channel flexible led strip with RGB+W/NW/CW, 4 colors in 1 chip;
- Standard is CRI80 for white color, CRI 90 is also available;
- Compatible with most of RGBW controllers in the markets;
- 24V DC input, less heat and voltage drop than 12V DC.

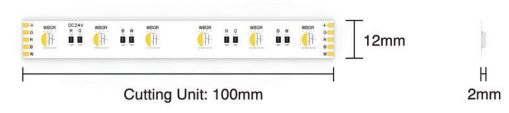

RGB W 4in1 IP54 IP65 IP67 IP68 24V 12mm Width 5M REEL

**Basic Parameters**

Power	16W/m
Input Voltage	24VDC
Input Current	0.8A/m
Cutting Unit	6LEDs/100mm
Size	5000×12×2mm
Bend Diameter	>60mm
Copper foil	2oz/3oz

**Luminous Intensity Distribution**

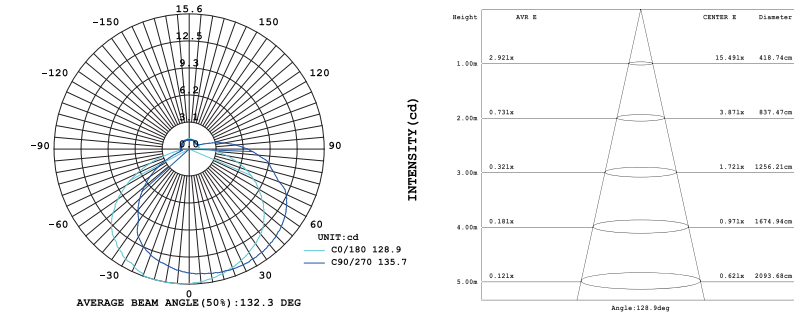

**Photo-electric Parameters**

CRI	CCT (°K)	LM/M	LM/W
>80	RGBW( 2700K) <span style="color:red">■</span> <span style="color:green">■</span> <span style="color:blue">■</span> <span style="color:orange">■</span>	784	49
	RGBW( 3000K) <span style="color:red">■</span> <span style="color:green">■</span> <span style="color:blue">■</span> <span style="color:orange">■</span>	784	49
	RGBW( 4000K) <span style="color:red">■</span> <span style="color:green">■</span> <span style="color:blue">■</span> <span style="color:orange">■</span>	816	51
	RGBW( 6000K) <span style="color:red">■</span> <span style="color:green">■</span> <span style="color:blue">■</span> <span style="color:lightblue">■</span>	816	51

**Recommended Accessories**

Image			
Code	5PIN-20AWG	VP+R8-1	LRS-150-24



**58** RGBW5050-24V-112D-12-20

5050 112LEDS/M

- Khun Four channel flexible led strip with RGB+W/NW/CW, 4 colors in 1 chip;
- Standard is CRI80 for white color, CRI 90 is also available;
- Compatible with most of RGBW controllers in the markets;
- 24V DC input, less heat and voltage drop than 12V DC.

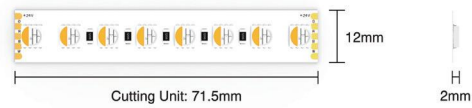

**Basic Parameters**

Power	22W/m
Input Voltage	24VDC
Input Current	0.937A/m
Cutting Unit	8LEDs/71.5mm
Size	5000×12×2mm
Bend Diameter	>60mm
Copper foil	3oz

**Luminous Intensity Distribution**

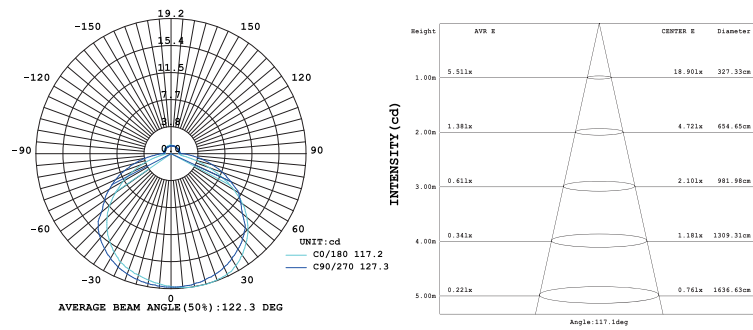

**Photo-electric Parameters**

CRI	CCT (°K)	LM/M	LM/W
>80	RGBW( 2700K)	1210	55
	RGBW( 3000K)	1210	55
	RGBW( 4000K)	1276	58
	RGBW( 6000K)	1276	58

**Recommended Accessories**

Image	Code
	5PIN-20AWG
	VP+R8-1
	LRS-150-24

**59** RGB+W5050-24V-96D-12-20

5050 96LEDS/M

- Khun 48 pcs 5050 RGB + 48 pcs 5050 White, stable and high brightness;
- White Color temperature between 1800-10000K is optional;
- Compatible with most of RGBW controllers in the markets;
- 24V DC input, less heat and voltage drop than 12V DC.

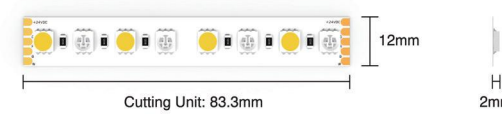

**Basic Parameters**

Power	22W/m
Input Voltage	24VDC
Input Current	0.917A/m
Cutting Unit	8LEDs/83.33mm
Size	5000×12×2mm
Bend Diameter	>60mm
Copper foil	3oz

**Luminous Intensity Distribution**

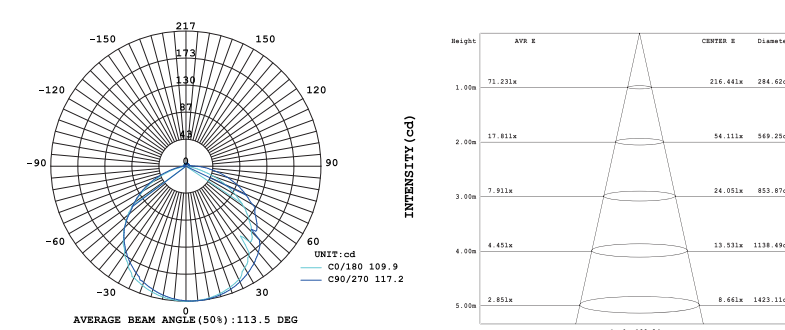

**Photo-electric Parameters**

CRI	CCT (°K)	LM/M	LM/W
>80	RGBW( 2700K)	1144	52
	RGBW( 3000K)	1144	52
	RGBW( 4000K)	1188	54
	RGBW( 6000K)	1188	54

**Recommended Accessories**

Image	Code
	5PIN-20AWG
	VP+R8-1
	LRS-150-24

**60** RGB+W5050/2835-24V-192D-12-20

5050 192LEDS/M

- Khun 96 pcs 5050 RGB + 96 pcs 2835 White, double row;
- White Color temperature between 1800-10000K is optional;
- Compatible with most of RGBW controllers in the markets;
- 24V DC input, less heat and voltage drop than 12V DC.

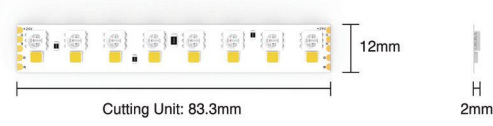

RGB W Double Row IP54 IP67 24V 12mm Width 5M REEL

Basic Parameters

Power	24W/m
Input Voltage	24VDC
Input Current	1A/m
Cutting Unit	16LEDs/83.3mm
Size	5000×12×2mm
Bend Diameter	>60mm
Copper foil	3oz

Luminous Intensity Distribution

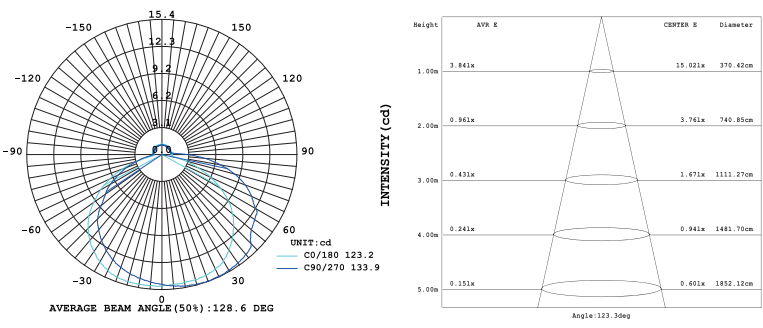

Photo-electric Parameters

CRI	CCT (°K)	LM/M	LM/W
>80	RGBW( 2700K)	1944	81
	RGBW( 3000K)	1944	81
	RGBW( 4000K)	1997	86
	RGBW( 6000K)	1997	86

Recommended Accessories

Image: Code: SPIN-20AWG, VP+R8-1, LRS-150-24

**61** RGBWW5050-24V-96D-12-20

5050 96LEDS/M

- Khun Five channels flexible led strip with RGB+WW+CW, 5 in 1 chip SMD;
- Compatible with most of controllers in the market;
- Standard is CRI>80 on white color, CRI90+, 95+ are available;
- Offer different IP rates for different applications.

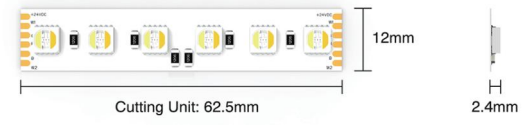

RGB WW 5in1 IP54 IP65 IP67 IP68 24V 12mm Width 5M REEL

Basic Parameters

Power	30W/m
Input Voltage	24VDC
Input Current	1.25A/m
Cutting Unit	6LEDs/62.5mm
Size	5000×12×2.4mm
Bend Diameter	>60mm
Copper foil	3oz

Luminous Intensity Distribution

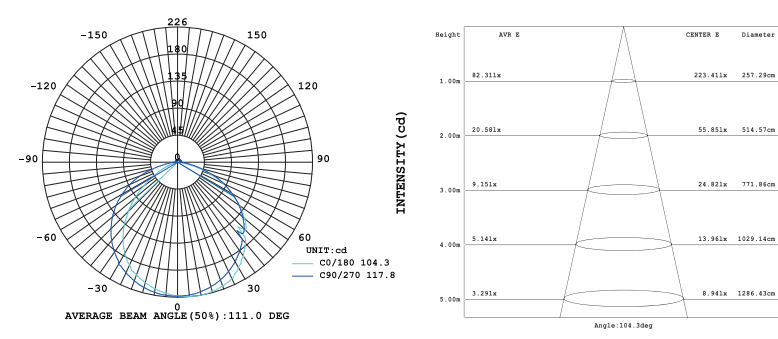

Photo-electric Parameters

CRI	CCT (°K)	LM/M	LM/W
>80	2300K+6500K	1982	64

Recommended Accessories

Image: Code: 6PIN-20AWG, V5-M+R17, LRS-200-24

**62 RGBWW5050-24V-112D-12-20**

5050 112LEDS/M

- Five channels flexible led strip with RGB+WW+CW, 5 in 1 chip SMD;
- Compatible with most of controllers in the market;
- Standard is CRI>80 on white color, CRI90+, 95+ are available;
- Offer different IP rates for different applications.

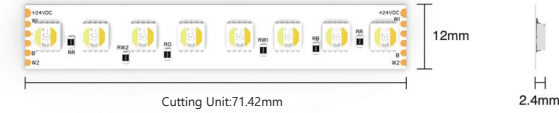

RGB WW 5in1 IP54 IP65 IP67 IP68 24V 12mm Width 5M REEL

**Basic Parameters**

Power	30W/m
Input Voltage	24VDC
Input Current	1.25A/m
Cutting Unit	8LEDs/71.42mm
Size	5000×12×2.4mm
Bend Diameter	>60mm
Copper foil	3oz

**Luminous Intensity Distribution**

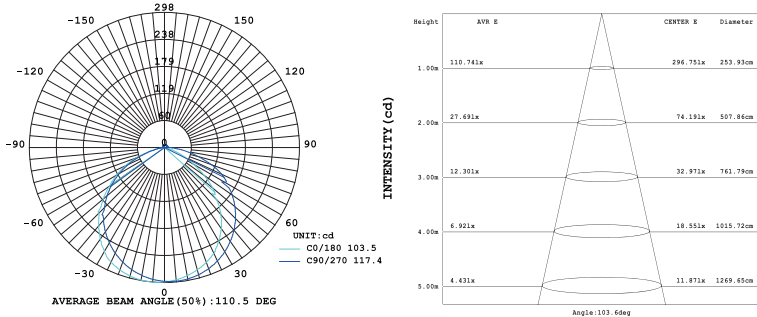

**Photo-electric Parameters**

CRI	CCT (°K)	LM/M	LM/W
>80	2300K+6500K <span style="color:red">■</span> <span style="color:green">■</span> <span style="color:blue">■</span>	2560	87

**Recommended Accessories**

Image	Code
	6PIN-20AWG
	V5-M+R17
	LRS-200-24

**63 RGB+W+W5050/2835-12V-72D-12-20**

5050+2835 72LEDS/M RGB+WW+CW

- Five channels flexible led strip with 5050 RGB+ 2835 WW+ CW;
- Standard is CRI>80 on white color, CRI90+, 95+ are available.
- Compatible with most of controllers in the market;
- Offer different IP rates for different applications.
- Alternative to Philips.

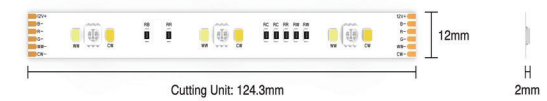

RGB CCT IP54 IP65 IP67 IP68 12V 12mm Width 5M REEL

**Basic Parameters**

Power	13W/m
Input Voltage	12VDC
Input Current	1.08A/m
Cutting Unit	9LEDs/124.3mm
Size	5000×12×2mm
Bend Diameter	>60mm
Copper foil	3oz

**Luminous Intensity Distribution**

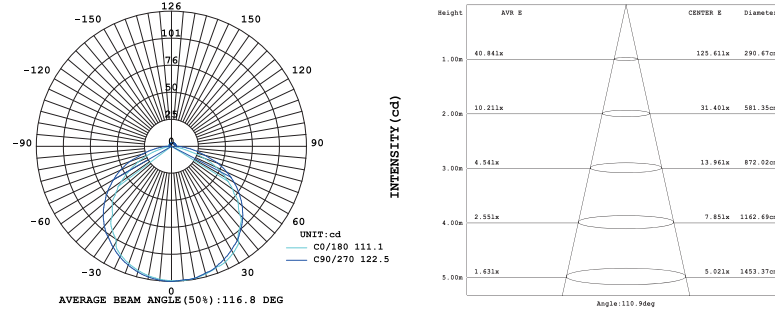

**Photo-electric Parameters**

CRI	CCT (°K)	LM/M	LM/W
>80	2300K+6500K <span style="color:red">■</span> <span style="color:green">■</span> <span style="color:blue">■</span>	1073	79

**Recommended Accessories**

Image	Code
	6PIN-20AWG
	V5-M+R17
	LRS-100-24



# MULTI-COLOR SERIES

## 64 RGB+W+W3838/2216-24V-336D-12-20

3838/2216 336LEDS/M RGB+WW+CW

- Khun Five channels flexible led strip with 3838 RGB+2216WW + CW;
- Compatible with most of controllers in the market;
- Standard is CRI>90 on white color, CRI95+ is available;
- Offer different IP rates for different applications.

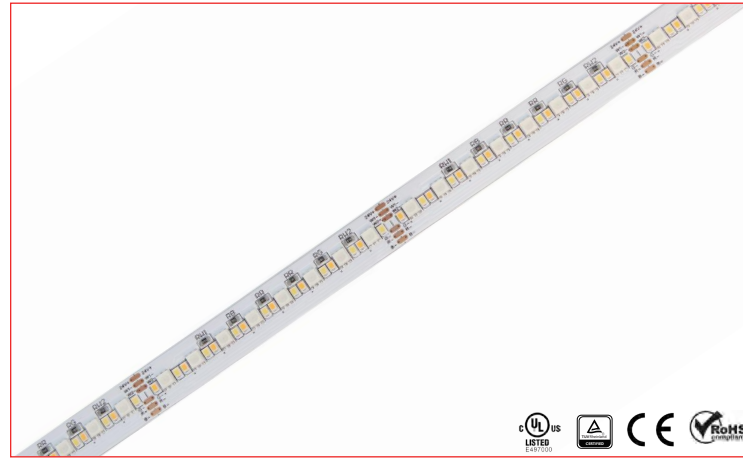

### Basic Parameters

Power	24W/m
Input Voltage	24VDC
Input Current	1A/m
Cutting Unit	24LEDs/71.7mm
Size	5000x12x2mm
Bend Diameter	>60mm
Copper foil	3oz

### Luminous Intensity Distribution

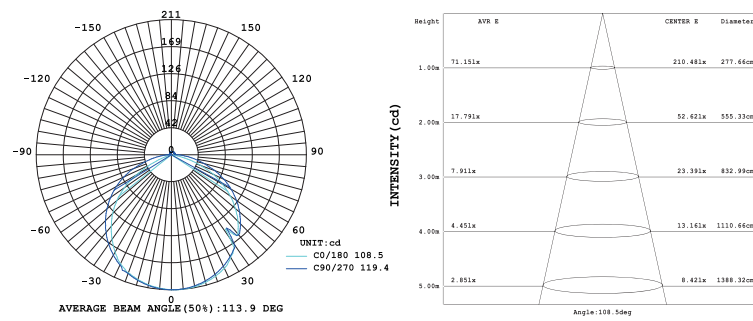

### Photo-electric Parameters

CRI	CCT (°K)	LM/M	LM/W
>80	2700K+6500K	1968	79

### Recommended Accessories

Image	Code
	6PIN-20AWG
	V5-M+R17
	LRS-150-24

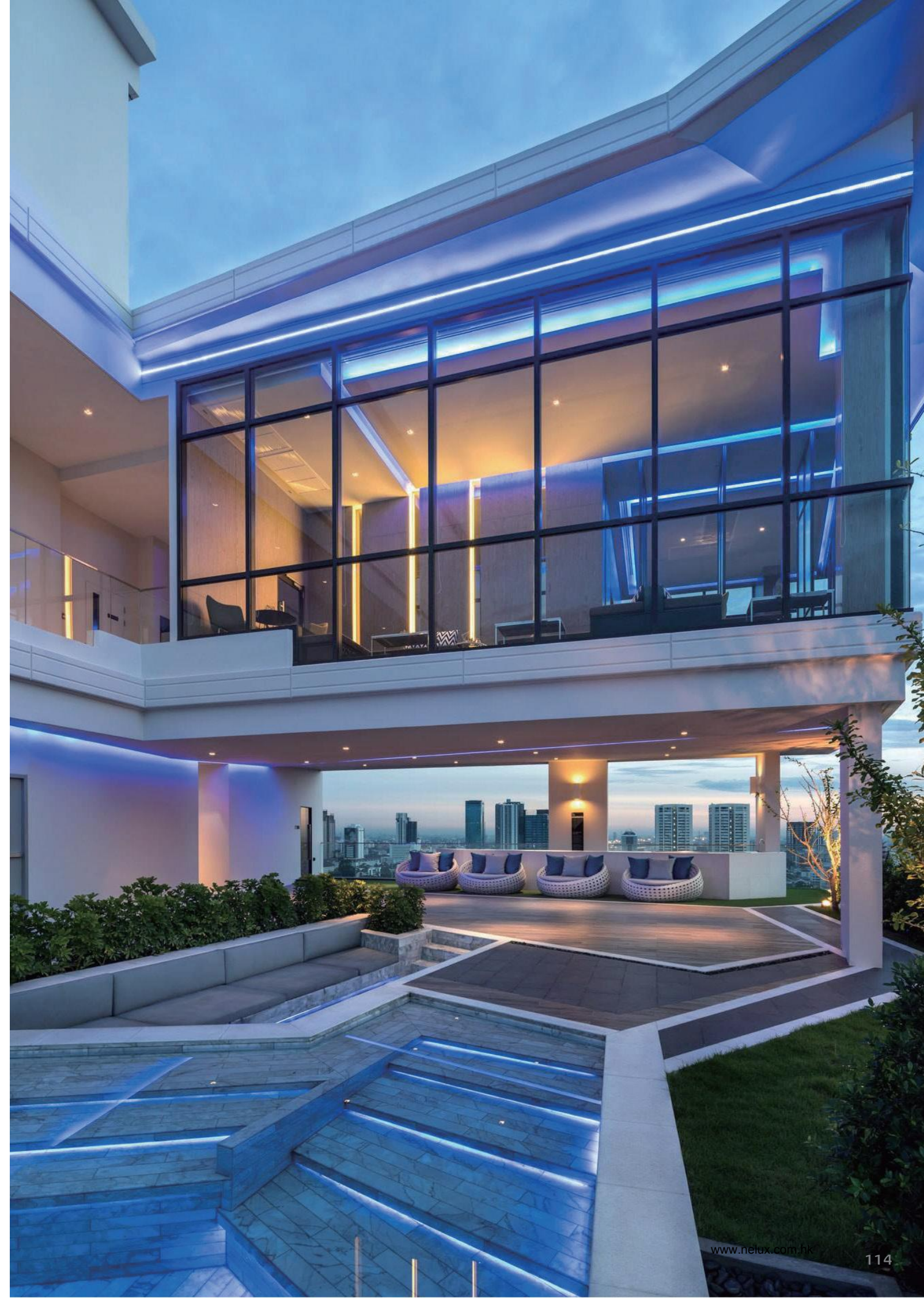



# Khun Digital Series

SPI&DMX digital  
Digital LED Strips

Good anti-interference capacity.  
Same brightness from head end to tail end, no color change.  
Can be programming for various mode.



## 65 SPI5050RGB-5V-60D-10-20 5050 60LEDS/M

- Khun SPI digital led strip light.
- Applying SMD5050 IC build-in LEDs to achieve addressable.
- Suitable for advertising, hotel, bar, KTV, bridges, walls and other interior & exterior lighting project.
- 2 years warranty.

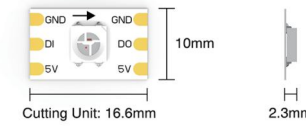

### Basic Parameters

Power	12W/m
Input Voltage	5VDC
Input Current	2.4A/m
Cutting Unit	1LEDs/16.6mm
Size	5000×10×2.3mm
Bend Diameter	>60mm
Copper foil	2oz

### Luminous Intensity Distribution

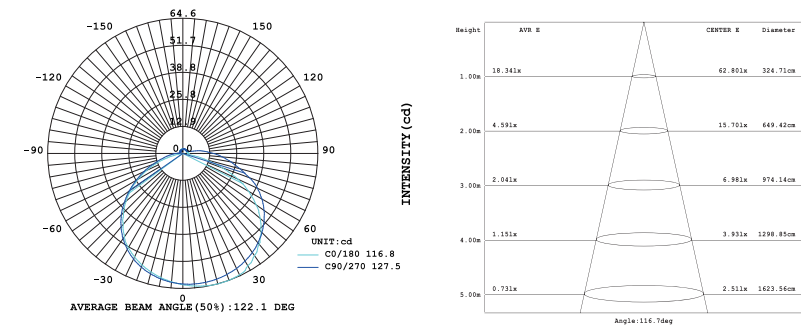

### Photo-electric Parameters

CRI	COLOR	LM/M	LM/W
/	RGB	252	21

### Recommended Accessories

Image	Code
	SC
	R8-1
	LRS-100-5

**66 SPI2835-24V-120D-5-20**

2835 120LEDs/M

- Khun SPI digital led strip light.
- Applying SMD 2835 white highlight LEDs, with external WS2811 IC, can achieve the effect of flowing water by controller.
- Suitable for advertising, hotel, bar, KTV, bridges, walls and other interior & exterior lighting project.
- 2 years warranty.

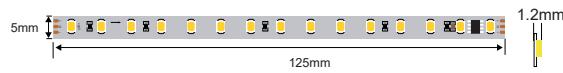

WS 2811 IP54 IP65 IP67 IP68 24V 5mm Width 5M REEL

**Basic Parameters**

Power	10W/m
Input Voltage	24VDC
Input Current	0.416A/m
Cutting Unit	15LEDs/125mm
Size	5000×5×1.2mm
Bend Diameter	>60mm
Copper foil	2oz

**Luminous Intensity Distribution**

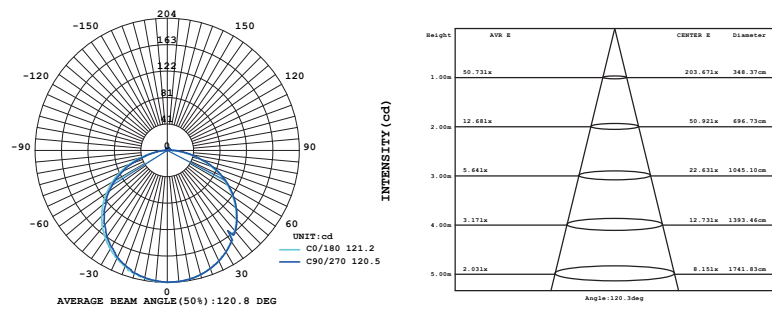

**Photo-electric Parameters**

CRI	CCT (°K)	LM/M	LM/W
>80	2700K	700	70
	3000K	700	70
	4000K	740	74
	6000K	740	74

**Recommended Accessories**

Image:   
 Code: SC R6 LRS-75-24

**67 SPI5050RGBID-12V-144D-12-20**

5050 60LEDs/M

- Khun SPI digital led strip light.
- WS2815 LED strip is a 3-channel adjustable strip with built-in IC, operated by dedicated LED controllers.
- One LED as one individually adjustable pixel Signal break-point continuous transmission, a failure of any pixel does not affect the transmission of signal and the total emitting effect.
- Suitable for advertising, hotel, bar, KTV, bridges, walls and other interior & exterior lighting project.
- 2 years warranty.

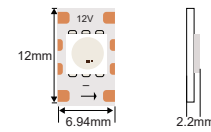

WS 2815 IP54 IP65 IP67 IP68 12V 12mm Width 5M REEL

**Basic Parameters**

Power	20W/m
Input Voltage	12VDC
Input Current	1.67A/m
Cutting Unit	1LEDs/6.94mm
Size	5000×12×2.2mm
Bend Diameter	>60mm
Copper foil	3oz

**Luminous Intensity Distribution**

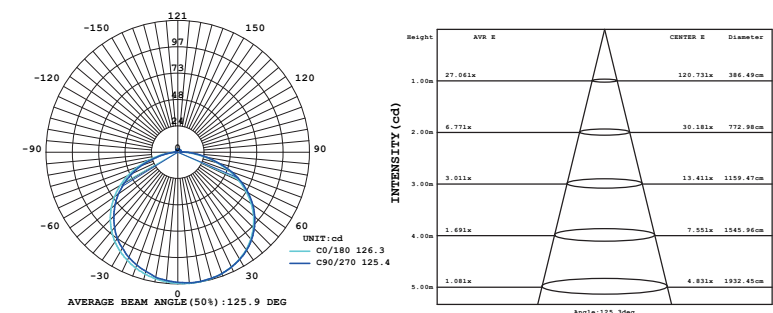

**Photo-electric Parameters**

CRI	COLOR	LM/M	LM/W
/	RGB	500	25

**Recommended Accessories**

Image:   
 Code: SC R8-1 LRS-150-12



**68** SPI5050RGBID-24V-60D-10-20

5050 60LEDS/M

- Khun SPI digital led strip light.
- With External IC WS2818, which is a 3-channel LED driver control circuit that includes an intelligent digital port data latch and a signal reshaping amplification drive circuit.
- WS2818 has good features in Signal Break-Point Continuous Transmission,adopts dual signal transmission.
- Suitable for advertising, hotel, bar, KTV, bridges, walls and other interior & exterior lighting project.
- 2 years warranty.



WS 2818 IP54 IP65 IP67 IP68 24V 10mm Width 5M REEL

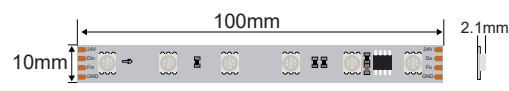

Basic Parameters

Power	12W/m
Input Voltage	24VDC
Input Current	0.5A/m
Cutting Unit	6LEDs/100mm
Size	5000×10×2.1mm
Bend Diameter	>60mm
Copper foil	2oz

Luminous Intensity Distribution

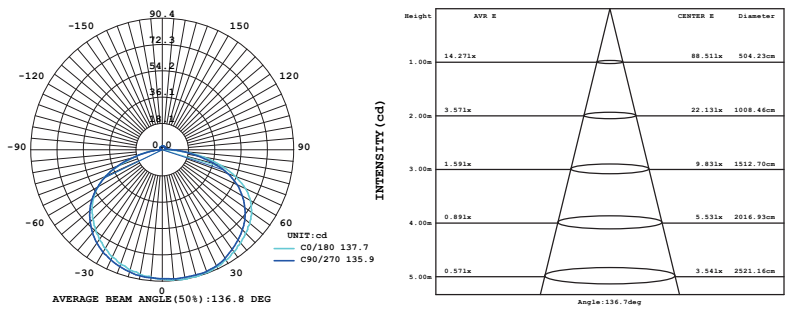

Photo-electric Parameters

CRI	COLOR	LM/M	LM/W
/	RGB	384	32

Recommended Accessories

Image			
Code	SC	R8-1	LRS-100-24

**69** SPI5050RGB-12V-60D-10-20

5050 60LEDS/M

- Khun SPI digital led strip light.
- Applying SMD5050 highlight LEDs, with external TM1923IC, can achieve full color effect by controller.
- Suitable for advertising, hotel, bar, KTV, bridges, walls and other interior & exterior lighting project.
- 2 years warranty.



SPI TM1923 IP54 IP65 IP67 IP68 24V 10mm Width 5M REEL

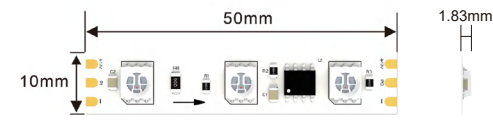

Basic Parameters

Power	15W/m
Input Voltage	12VDC
Input Current	1.281A/m
Cutting Unit	3LEDs/50mm
Size	5000×10×1.83mm
Bend Diameter	>60mm
Copper foil	2oz

Luminous Intensity Distribution

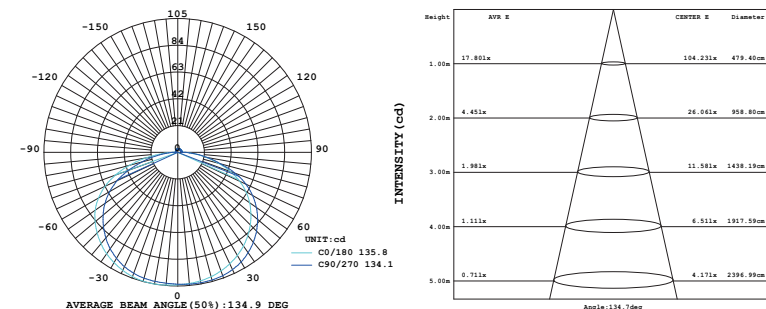

Photo-electric Parameters

CRI	COLOR	LM/M	LM/W
/	RGB	408	26

Recommended Accessories

Image			
Code	SC	R8-1	LRS-100-12

**70 DMX5050RGB-24V-60D-10-20**

5050 60LEDS/M

- Khun DMX digital led strip light.
- Applying SMD5050 highlight LEDs, with external TM 512AC, can achieve full color effect by controller.
- Suitable for advertising, hotel, bar, KTV, bridges, walls and other interior & exterior lighting project.
- 2 years warranty.

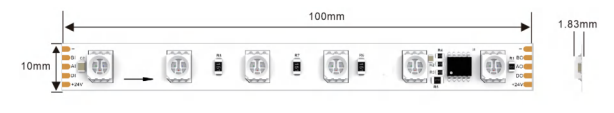

**NEW**

DMX TM512AC IP54 IP65 IP67 IP68 24V 10mm Width 5M REEL

**Basic Parameters**

Power	15W/m
Input Voltage	24VDC
Input Current	0.643A/m
Cutting Unit	6LEDs/100mm
Size	5000×10×1.83mm
Bend Diameter	>60mm
Copper foil	2oz

**Luminous Intensity Distribution**

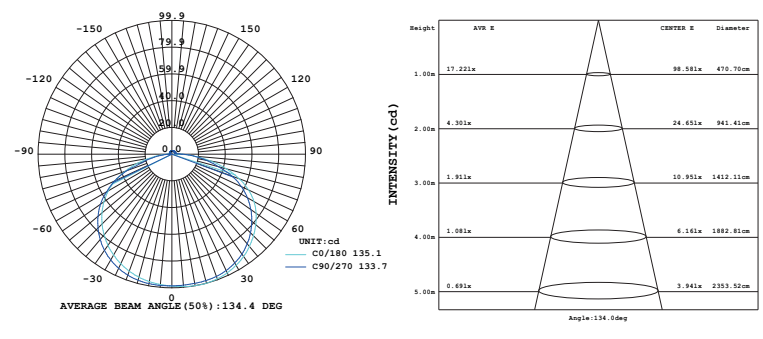

**Photo-electric Parameters**

CRI	COLOR	LM/M	LM/W
/	RGB	383	24

**Recommended Accessories**

Image:

Code: XC R8-1 LRS-100-12

**71 SPI5050RGB-24V-84D-10-20**

5050 84LEDS/M

- Khun SPI digital led strip light.
- Applying SMD5050 highlight LEDs, with external TM1923 IC, can achieve full color effect by controller.
- Suitable for advertising, hotel, bar, KTV, bridges, walls and other interior & exterior lighting project.
- 2 years warranty.

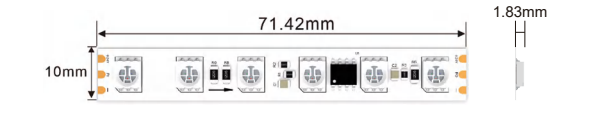

**NEW**

SPI TM1923 IP54 IP65 IP67 IP68 24V 10mm Width 5M REEL

**Basic Parameters**

Power	22W/m
Input Voltage	24VDC
Input Current	0.926A/m
Cutting Unit	6LEDs/71.42mm
Size	5000×10×1.83mm
Bend Diameter	>60mm
Copper foil	2oz

**Luminous Intensity Distribution**

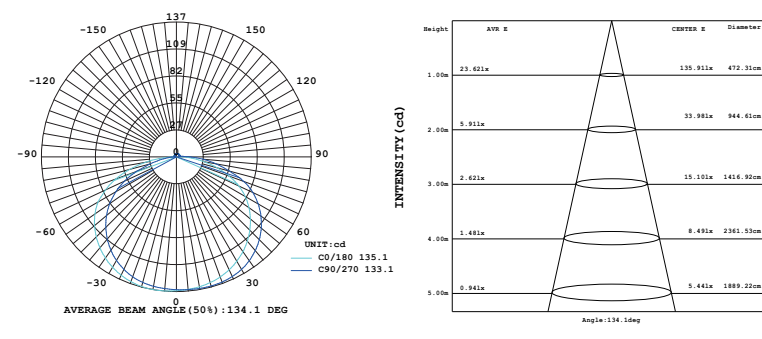

**Photo-electric Parameters**

CRI	COLOR	LM/M	LM/W
/	RGB	565	25

**Recommended Accessories**

Image:

Code: SC R8-1 LRS-150-24



**72** DMX5050RGB-24V-84D-10-20

5050 84LEDS/M

- DKhun MX digital led strip light.
- Applying SMD5050 highlight LEDs, with external TM 512AC, can achieve full color effect by controller.
- Suitable for advertising, hotel, bar, KTV, bridges, walls and other interior & exterior lighting project.
- 2 years warranty.

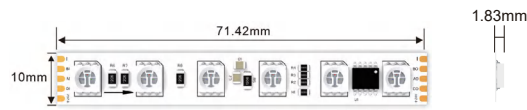

Basic Parameters

Power	22W/m
Input Voltage	24VDC
Input Current	0.893A/m
Cutting Unit	6LEDs/71.42mm
Size	5000×10×1.83mm
Bend Diameter	> 60mm
Copper foil	2oz

Photo-electric Parameters

CRI	COLOR	LM/M	LM/W
/	RGB <span style="color:red">■</span> <span style="color:green">■</span> <span style="color:blue">■</span>	532	24

Recommended Accessories

Image			
Code	XC	R8-1	LRS-150-24

**NEW**



Luminous Intensity Distribution

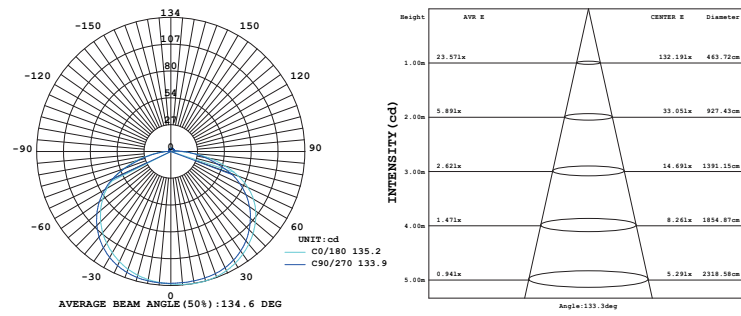

**73** DMX5050RGBW-24V-48D-12-20

5050 48LEDS/M

- Khun DMX digital led strip light.
- Applying SMD 5050 highlight LEDs, with external DMX512 IC, can achieve full color effect by controller.
- Suitable for advertising, hotel, bar, KTV, bridges, walls and other interior & exterior lighting project.
- 2 years warranty.

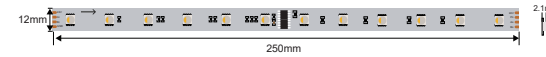

Basic Parameters

Power	12W/m
Input Voltage	24VDC
Input Current	0.5A/m
Cutting Unit	12LEDs/250mm
Size	5000×10×2.1mm
Bend Diameter	> 60mm
Copper foil	2oz

Photo-electric Parameters

CRI	CCT (°K)	LM/M	LM/W
>80	RGBW(2700K) <span style="color:red">■</span> <span style="color:green">■</span> <span style="color:blue">■</span> <span style="color:orange">■</span>	480	40
	RGBW(3000K) <span style="color:red">■</span> <span style="color:green">■</span> <span style="color:blue">■</span> <span style="color:orange">■</span>	480	40
	RGBW(4000K) <span style="color:red">■</span> <span style="color:green">■</span> <span style="color:blue">■</span> <span style="color:orange">■</span>	504	42
	RGBW(6000K) <span style="color:red">■</span> <span style="color:green">■</span> <span style="color:blue">■</span> <span style="color:lightblue">■</span>	504	42

Recommended Accessories

Image			
Code	XC	R8-1	LRS-100-24

**NEW**



Luminous Intensity Distribution

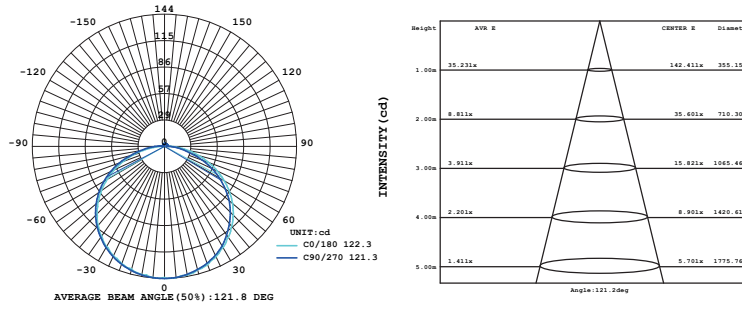

滚滚长江东逝水

**74** SPI5050RGBW-24V-60D-10-20

5050 60LEDS/M

- Khun SPI digital led strip light.
- Applying SMD 5050, external IC to achieve addressable.
- Suitable for advertising, hotel, bar, KTV, bridges, walls and other interior & exterior lighting project.
- 2 years warranty.



SPI TM1814 IP54 IP65 IP67 IP68 24V 10mm Width 5M REEL

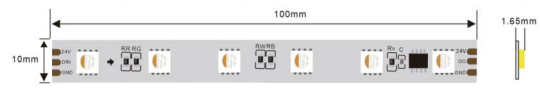

Basic Parameters

Power	32W/m
Input Voltage	24VDC
Input Current	1.346A/m
Cutting Unit	6LEDs/100mm
Size	5000×10×1.65mm
Bend Diameter	>60mm
Copper foil	3oz

Luminous Intensity Distribution

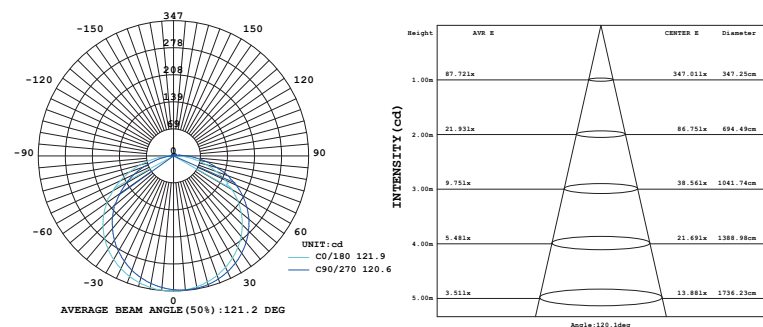

Photo-electric Parameters

CRI	CCT (°K)	LM/M	LM/W
>80	RGBW(2700K)	992	31
	RGBW(3000K)	992	31
	RGBW(4000K)	1092	33
	RGBW(6000K)	1092	33

Recommended Accessories

Image: Code: SC R8-1 LRS-150-24

**75** DMX5050RGBW-24V-60D-10-20

5050 60LEDS/M

- Khun DMX digital led strip light.
- Applying SMD 5050 highlight LEDs, with external TM512AC, can achieve full color effect by controller.
- Suitable for advertising, hotel, bar, KTV, bridges, walls and other interior & exterior lighting project.
- 2 years warranty.



DMX TM512AC IP54 IP65 IP67 IP68 24V 10mm Width 5M REEL



Basic Parameters

Power	18W/m
Input Voltage	24VDC
Input Current	0.786A/m
Cutting Unit	6LEDs/100mm
Size	5000×10×1.65mm
Bend Diameter	>60mm
Copper foil	3oz

Luminous Intensity Distribution

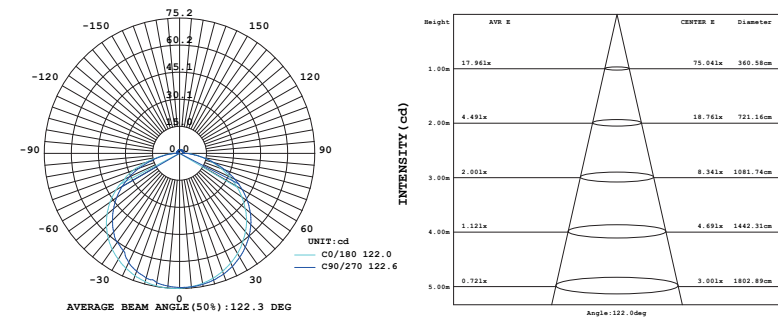

Photo-electric Parameters

CRI	CCT (°K)	LM/M	LM/W
>80	RGBW(2700K)	612	34
	RGBW(3000K)	612	34
	RGBW(4000K)	696	36
	RGBW(6000K)	696	36

Recommended Accessories

Image: Code: XC R8-1 LRS-150-24



**76 SPI5050RGBW-24V-84D-12-20**

5050 84LEDS/M

- Khun SPI digital led strip light.
- Applying 5050 RGBW LEDs, with external TM1814 IC to achieve addressable.
- Suitable for advertising, hotel, bar, KTV, bridges, walls and other interior & exterior lighting project.
- 2 years warranty.



**NEW**

SPI TM1814 IP54 IP65 IP67 IP68 24V 12mm Width 5M REEL

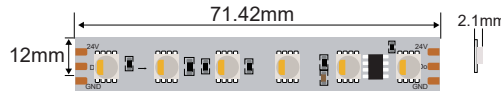

**Basic Parameters**

Power	27W/m
Input Voltage	24VDC
Input Current	1.125A/m
Cutting Unit	6LEDs/71.42mm
Size	5000×12×2.1mm
Bend Diameter	> 60mm
Copper foil	2oz

**Luminous Intensity Distribution**

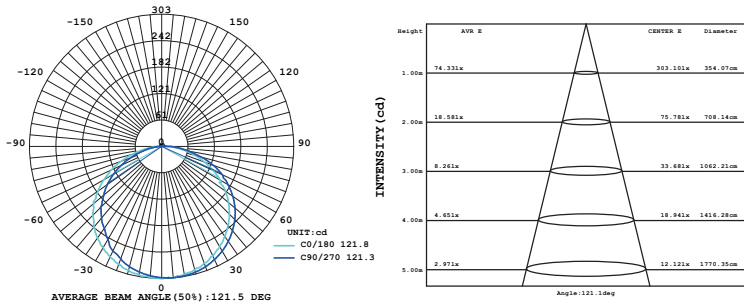

**Photo-electric Parameters**

CRI	CCT (°K)	LM/M	LM/W
>80	RGBW(2700K)	945	35
	RGBW(3000K)	945	35
	RGBW(4000K)	999	37
	RGBW(6000K)	999	37

**Recommended Accessories**

Image			
Code	SC	R8-1	LRS-200-24





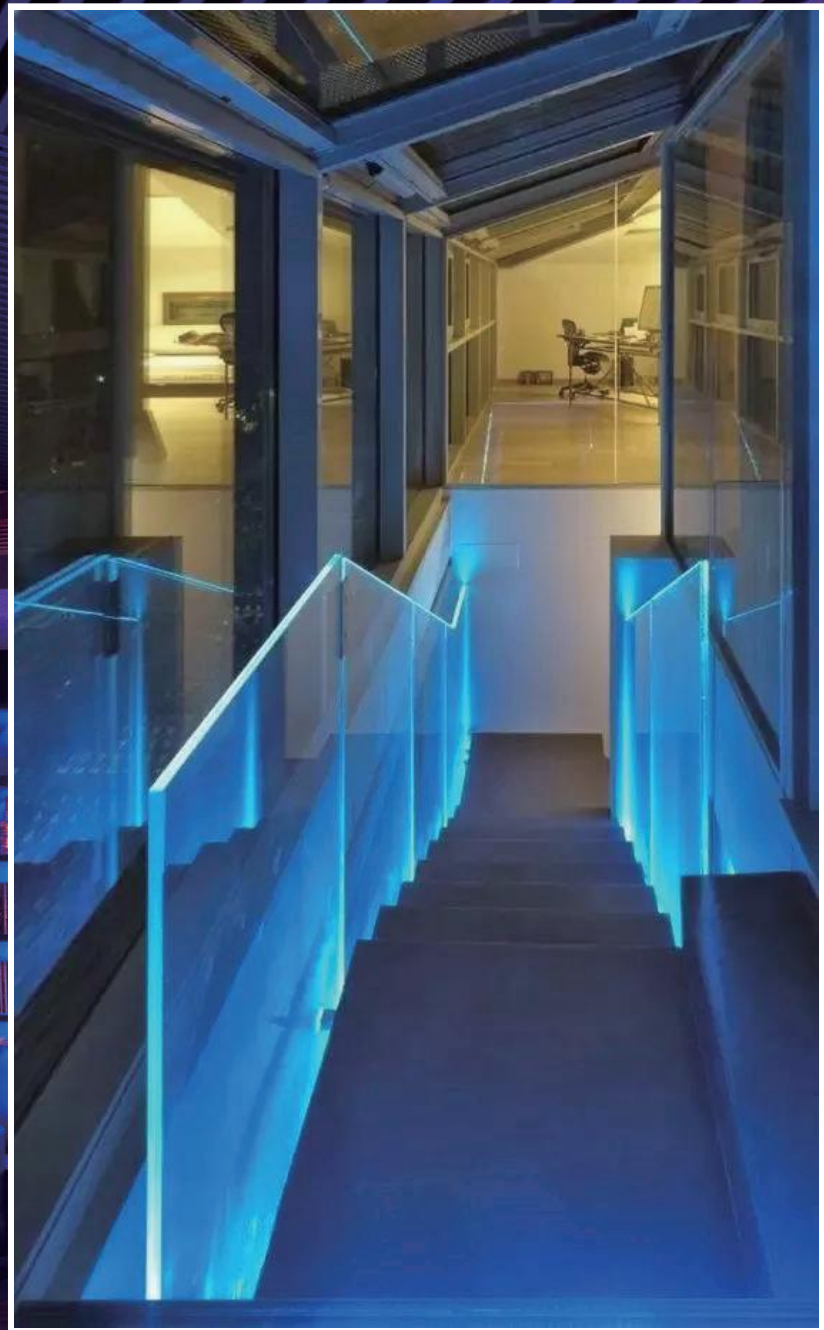



**77 COB2016-24V-480D-8-20**

**COB2016 480LEDs/M**

- Beautiful linear effect with big beam angle 180°.
- Adopt brand LED chip, achieving good quality and high brightness.
- Our COB led strip is certified by CE ROHS.
- Easy to install and preserve.
- Available with 2700K/3000K/4000K/6500K/R/G/B.

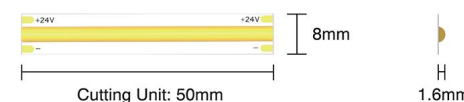

COB Pass ERP IP54 IP65 IP67 24V 8 mm 5M REEL

**Basic Parameters**

Power	10W/m
Input Voltage	24VDC
Input Current	0.417A/m
Cutting Unit	24LEDs/50mm
Size	5000×8×1.6mm
Bend Diameter	>60mm
Copper foil	2oz

**Luminous Intensity Distribution**

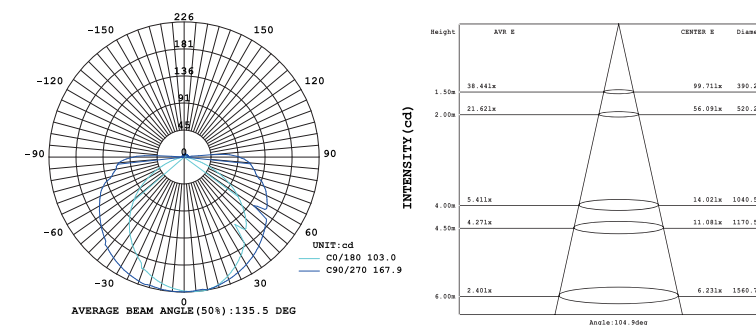

**Photo-electric Parameters**

	CCT (°K)	LM/M	LM/W	Energy Efficiency CLASS
>90	2700K	910	92	F
	3000K	910	92	F
	4000K	980	98	F
	6000K	980	98	F

**Recommended Accessories**

Image	Code
	2PIN-18AWG
	HM-N8BB-2PIN
	V1+R6-1
	LRS-75-24

**Khun COB Series**

Light line and dot-free COB Strips

Big emitting angle, CRI>90.  
Suit for furniture lighting and decorative lighting application.  
10 optional 2700K\3000K\4000K\6500K\R\G\B\Y\RGB\RGBW



**78 COB2016-12V-512D-10-20**

**COB2016 512LEDs/M**

- Beautiful linear effect with big beam angle 180°.
- Adopt brand LED chip, achieving good quality and high brightness.
- Our COB led strip is certified by CE ROHS.
- Easy to install and preserve.
- Available with 2700K/3000K/4000K/6500K/R/G/B.

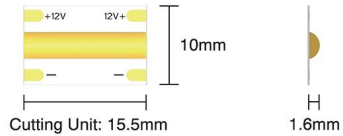

COB Pass ERP IP54 IP65 IP67 12V 10mm 5M REEL

**Basic Parameters**

Power	12W/m
Input Voltage	12V;
Input Current	1A/m;
Cutting Unit	8LEDs/15.5mm;
Size	5000×10×1.6mm
Bend Diameter	>60mm
Copper foil	2oz

**Luminous Intensity Distribution**

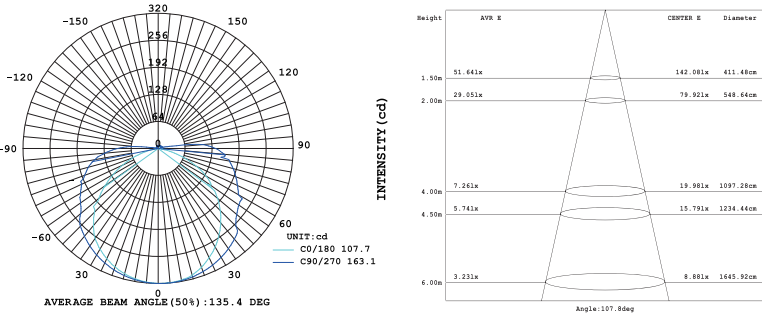

**Photo-electric Parameters**

	CCT (°K)	LM/M	LM/W	Energy Efficiency CLASS
>90	2700K	1152	96	F
	3000K	1152	96	F
	4000K	1212	101	F
	6000K	1212	101	F

**Recommended Accessories**

Image: Code: 2PIN-18AWG, HM-N10BB-2PIN, V1+R6-1, LRS-75-24

**79 COB2016-24V-546D-10-20**

**COB2016 546LEDs/M**

- Beautiful linear effect with big beam angle 180°.
- Adopt brand LED chip, achieving good quality and high brightness.
- Our COB led strip is certified by CE ROHS.
- Easy to install and preserve.
- Available with 2700K/3000K/4000K/6500K/R/G/B.

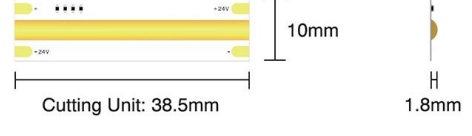
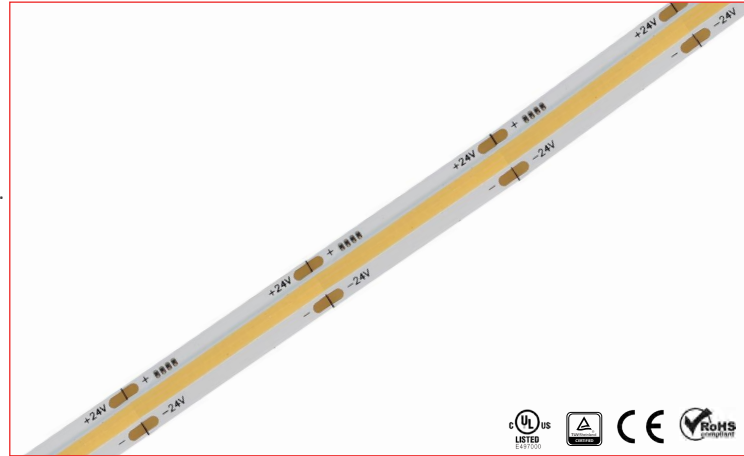

COB Dots free IP54 IP65 IP67 24V 10mm 5M REEL

**Basic Parameters**

Power	18W/m
Input Voltage	24VDC
Input Current	0.75A/m
Cutting Unit	21LEDs/38.5mm
Size	5000×10×1.8mm
Bend Diameter	>60mm
Copper foil	2oz

**Luminous Intensity Distribution**

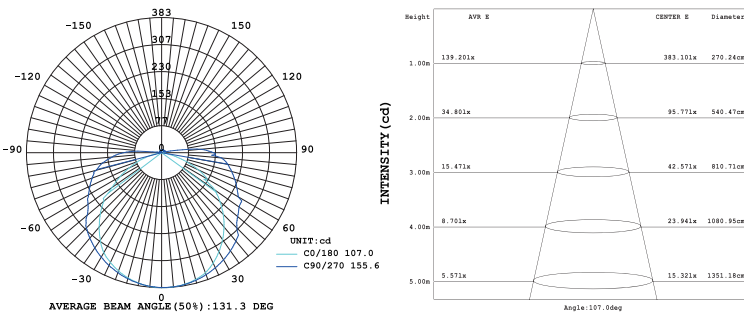

**Photo-electric Parameters**

	CCT (°K)	LM/M	LM/W	Energy Efficiency CLASS
>90	2700K	1332	74	/
	3000K	1332	74	/
	4000K	1404	78	/
	6000K	1404	78	/

**Recommended Accessories**

Image: Code: 2PIN-18AWG, HM-N10BB-2PIN, V1+R6-1, LRS-100-24

**80 COB2016-24V-528D-5-20**

COB2016 528LEDs/M

- Beautiful linear effect with big beam angle 180°.
- Adopt brand LED chip, achieving good quality and high brightness.
- Our COB led strip is certified by CE ROHS.
- Easy to install and preserve.
- Available with 2700K/3000K/4000K/6500K/R/G/B.

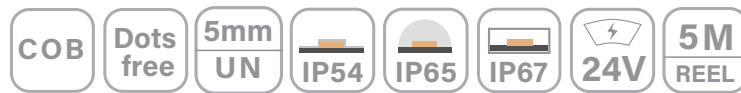
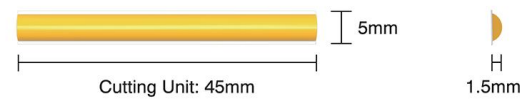

Basic Parameters

Power	9W/m
Input Voltage	24VDC
Input Current	0.375A/m
Cutting Unit	24LEDs/45mm
Size	5000×5×1.5mm
Bend Diameter	> 60mm
Copper foil	2oz

Luminous Intensity Distribution

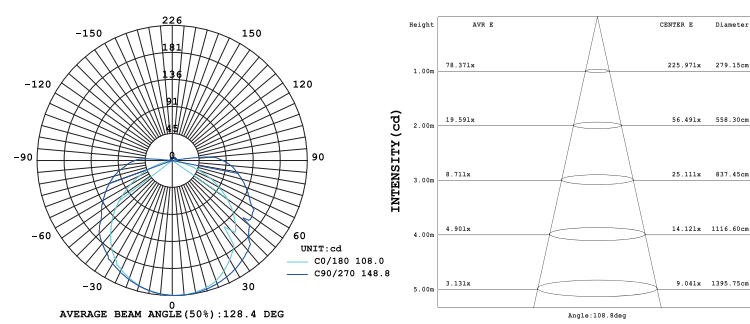

Photo-electric Parameters

	CCT (°K)	LM/M	LM/W	Energy Efficiency CLASS
>90	2700K	792	88	/
	3000K	792	88	/
	4000K	828	92	/
	6000K	828	92	/

Recommended Accessories



**81 COB2016-12V-400D-3-20**

COB2016 400LEDs/M

- Beautiful linear effect with big beam angle 180°.
- Adopt brand LED chip, achieving good quality and high brightness.
- Our COB led strip is certified by CE ROHS.
- Easy to install and preserve.
- Available with 2700K/3000K/4000K/6500K/R/G/B.

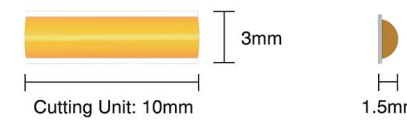

Basic Parameters

Power	4.8W/m
Input Voltage	12VDC
Input Current	0.4A/m
Cutting Unit	4LEDs/10mm
Size	5000×3×1.5mm
Bend Diameter	> 60mm
Copper foil	2oz

Luminous Intensity Distribution

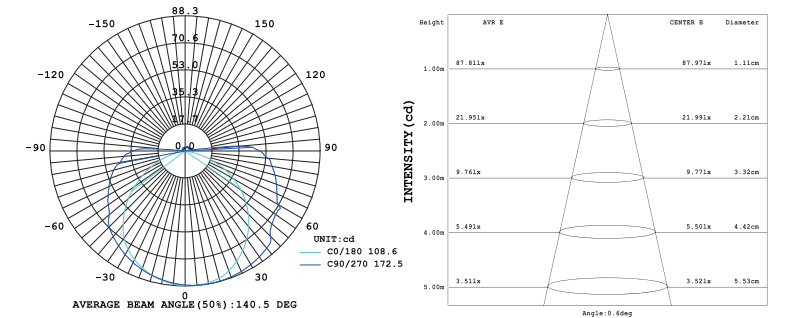
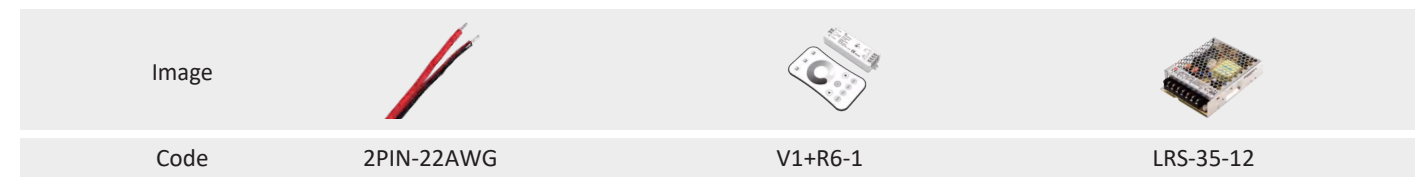

Photo-electric Parameters

	CCT (°K)	LM/M	LM/W	Energy Efficiency CLASS
>90	2700K	432	90	G
	3000K	432	90	G
	4000K	456	95	F
	6000K	456	95	F

Recommended Accessories





**82 COB2016CA-24V-640D-10-20**

**COB2016CA 640LEDs/M**

- Khun Beautiful linear effect with big beam angle 180°.
- Adopt brand LED chip, achieving good quality and high brightness.
- Our COB led strip is certified by CE ROHS.
- Easy to install and preserve.
- Adjustable from 2700K-6500K.

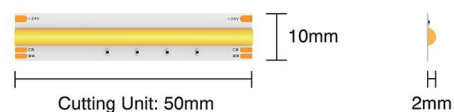

**Basic Parameters**

Power	16W/m
Input Voltage	24VDC
Input Current	0.667A/m
Cutting Unit	32LEDs/50mm
Size	5000×10×2mm
Bend Diameter	>60mm
Copper foil	2oz

**Luminous Intensity Distribution**

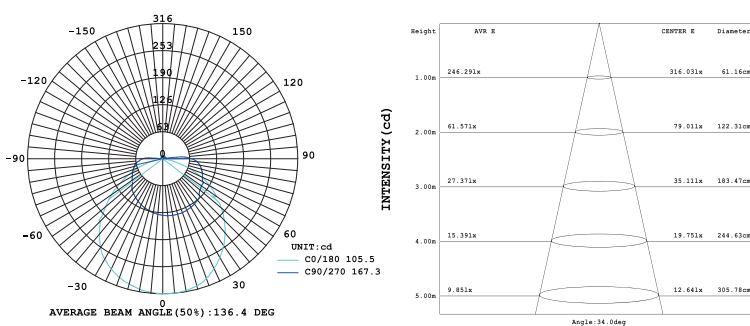

**Photo-electric Parameters**

CCT (°K)	LM/M	LM/W	Energy Efficiency CLASS
2700K	448	56	/
4000K	1168	73	/
6500K	768	96	/

**Recommended Accessories**



**83 COB2016RGB-24V-840D-10-20**

**COB2016 840LEDs/M**

- Khun Beautiful linear effect with big beam angle 180°.
- Adopt brand LED chip, achieving good quality and high brightness.
- Our COB led strip is certified by CE ROHS.
- Easy to install and preserve.
- RGB color, ideal for office, residential, retail and industry lighting.

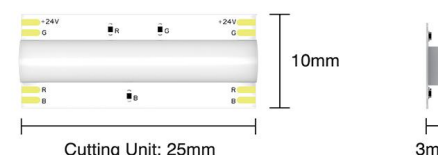

**Basic Parameters**

Power	15W/m
Input Voltage	24VDC
Input Current	0.625A/m
Cutting Unit	21LEDs/25mm
Size	5000×10×3mm
Bend Diameter	>60mm
Copper foil	2oz

**Luminous Intensity Distribution**

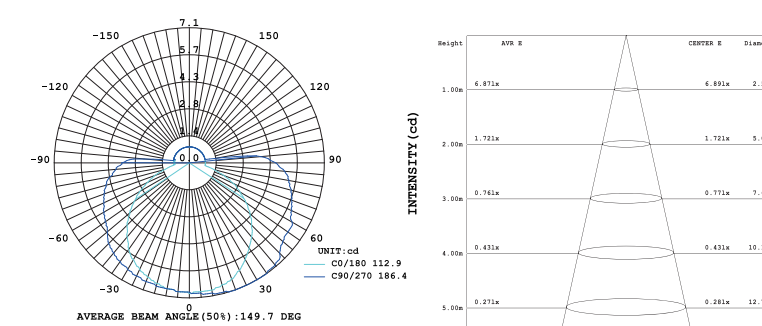

**Photo-electric Parameters**

COLOR	LM/M	LM/W
RGB	615	41

**Recommended Accessories**



**84 COB2016RGBW-24V-840D-12-20**

**COB2016 840LEDs/M**

- Beautiful linear effect with big beam angle 180°.
- Adopt brand LED chip, achieving good quality and high brightness.
- Our COB led strip is certified by CE ROHS.
- Easy to install and preserve.
- RGBW color use for more places.

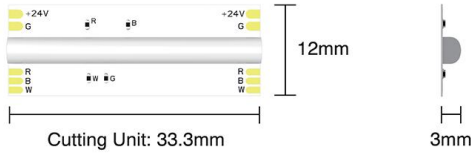
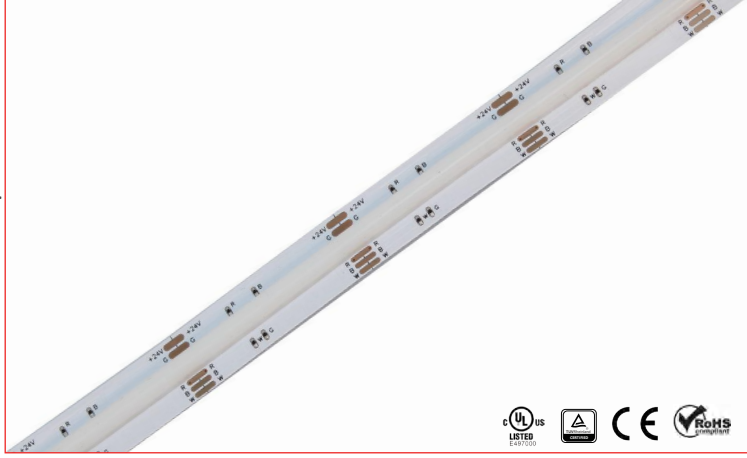

COB RGBW IP54 IP65 IP67 24V 12mm 5M REEL

**Basic Parameters**

Power	18W/m
Input Voltage	24VDC
Input Current	0.75A/m
Cutting Unit	21LEDs/33.3mm
Size	5000×12×3mm
Bend Diameter	> 60mm
Copper foil	2oz

**Luminous Intensity Distribution**

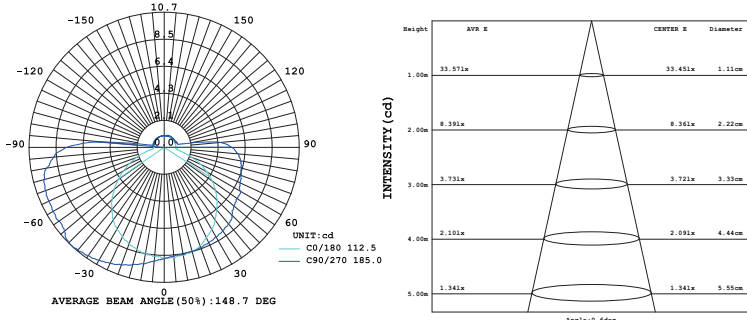

**Photo-electric Parameters**

	CCT (°K)	LM/M	LM/W
>90	RGBW( 2700K)	468	26
	RGBW( 3000K)	468	26
	RGBW( 4000K)	504	28
	RGBW( 6000K)	504	28

**Recommended Accessories**

Image: Code: 5PIN-20AWG, VP+R8-1, LRS-150-24

**85 COB2016SE-24V-480D-8-20**

**COB2016 480LEDs/M**

- Beautiful linear effect with big beam angle 180°.
- Adopt brand LED chip, achieving good quality and high brightness.
- Our COB led strip is certified by CE ROHS.
- Easy to install and preserve.
- Side emitting for styling.

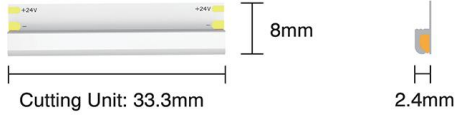

COB SIDE Emitting IP54 IP65 IP67 24V 8mm 5M REEL

**Basic Parameters**

Power	10W/m
Input Voltage	24VDC
Input Current	0.417A/m
Cutting Unit	16LEDs/33.3mm
Size	5000×8×2.4mm
Bend Diameter	> 60mm
Copper foil	2oz

**Luminous Intensity Distribution**

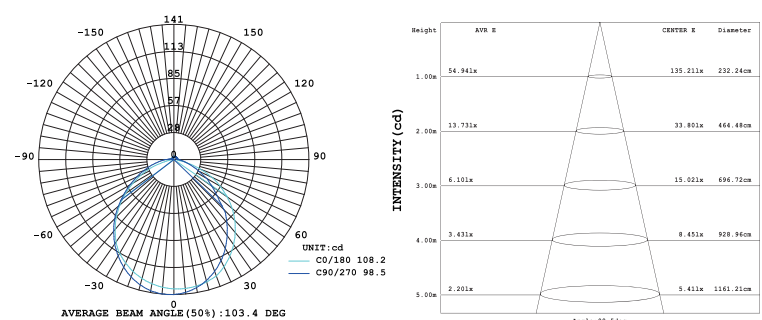

**Photo-electric Parameters**

	CCT (°K)	LM/M	LM/W	Energy Efficiency CLASS
>90	2700K	290	29	/
	3000K	308	31	/
	4000K	330	33	/
	6000K	350	35	/

**Recommended Accessories**

Image: Code: 2PIN-18AWG, V1+R6-1, LRS-75-12



**86** COBW2016-24V-512D-8-20

COB2016 512LEDs/M (Box dam)

- Has 120° beam angle, smaller than normal COB strip, achieve better lighting concentration and no light dot.
- Box dam design, has more delicate and beautiful appearance.
- Good quality, high brightness and competitive price.



COB Pass ERP IP54 IP65 IP67 24V 8mm 5M REEL

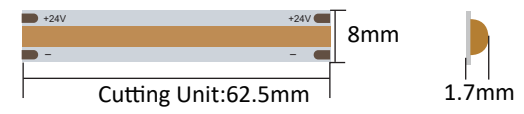

Basic Parameters

Power	10W/m
Input Voltage	24VDC
Input Current	0.4677A/m
Cutting Unit	32LEDs/62.5mm
Size	5000x8x1.7mm
Bend Diameter	>60mm
Copper foil	2oz

Luminous Intensity Distribution

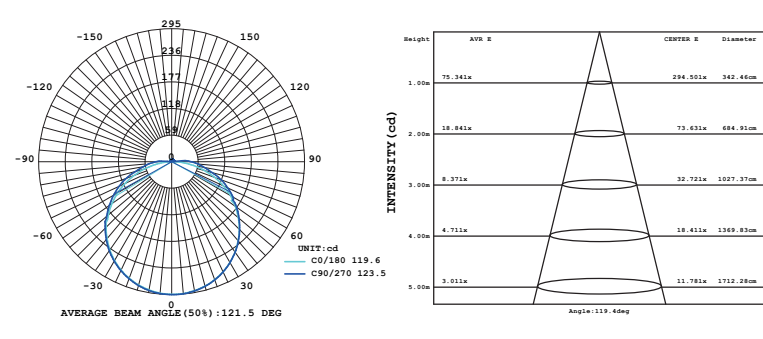

Photo-electric Parameters

	CCT (°K)	LM/M	LM/W	Energy Efficiency CLASS
>90	2700K	1080	86	F
	3000K	1080	86	F
	4000K	1134	100	F
	6000K	1134	100	F

Recommended Accessories

Image: Code: 2PIN-18AWG, V1+R6-1, RS-LRS-75-24

**87** COBW2016CA-24V-588D-12-20

COB2016 588LEDs/M (Box dam)

- Has 120° beam angle, smaller than normal COB strip, achieve better lighting concentration and no light dot.
- Box dam design, has more delicate and beautiful appearance.
- Good quality, high brightness and competitive price.



COB DUAL COLOR IP54 IP65 IP67 24V 12mm 5M REEL

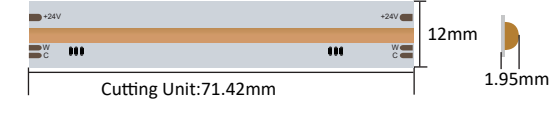

Basic Parameters

Power	14W/m
Input Voltage	24VDC
Input Current	0.5909A/m
Cutting Unit	42LEDs/71.42mm
Size	5000x12x1.95mm
Bend Diameter	>60mm
Copper foil	2oz

Luminous Intensity Distribution

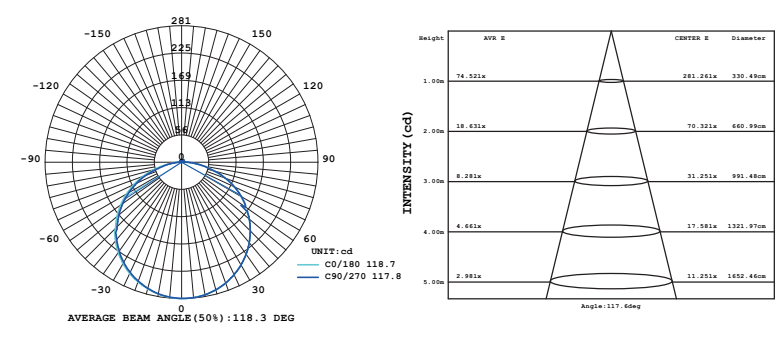

Photo-electric Parameters

	CCT (°K)	LM/M	LM/W	Energy Efficiency CLASS
>90	2700K	403	57	/
	4000K	908	64	/
	6500K	505	71	/

Recommended Accessories

Image: Code: 3PIN-18AWG, V2+R7-1, LRS-100-24

**88** COBW2016RGB-24V-1134D-12-20

COB2016 1134LEDs/M (Box dam)

- Khun Has 120° beam angle, smaller than normal COB strip, achieve better lighting concentration and no light dot.
- Box dam design, has more delicate and beautiful appearance.
- Good quality, high brightness and competitive price.

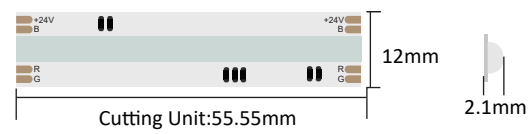

Basic Parameters

Power	15W/m
Input Voltage	24VDC
Input Current	0.6359A/m
Cutting Unit	63LEDs/55.55mm
Size	5000×12×2.1mm
Bend Diameter	>60mm
Copper foil	2oz

Luminous Intensity Distribution

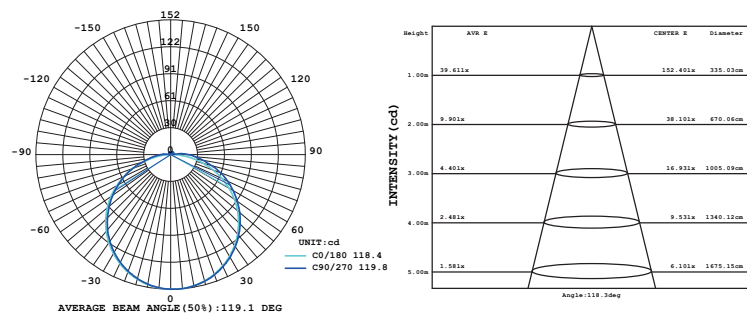

Photo-electric Parameters

COLOR	LM/M	LM/W
RGB	530	35

Recommended Accessories

Image	Code
	4PIN-20AWG
	V3+R8-1
	LRS-100-24

**89** COB2016NEON-24V-480D-8-67

COB2016 480LEDs/M

- Khun Easy to install and preserve.
- Our COB led strip is certified by CE ROHS.
- Apply environmental friendly material neon tube.
- Available with 2700K/3000K/4000K/6500K/R/G/B.
- No light dot, beautiful linear effect with big beam angle 180°.
- Adopt brand LED chip, achieving good quality and high brightness.

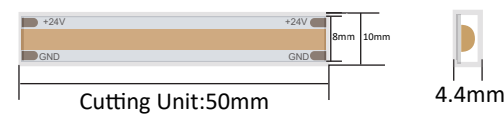

Basic Parameters

Power	9W/m
Input Voltage	24VDC
Input Current	0.4443A/m
Cutting Unit	24LEDs/50mm
Neon Size	4x10mm
Bend Diameter	>60mm
Copper foil	2oz

Luminous Intensity Distribution

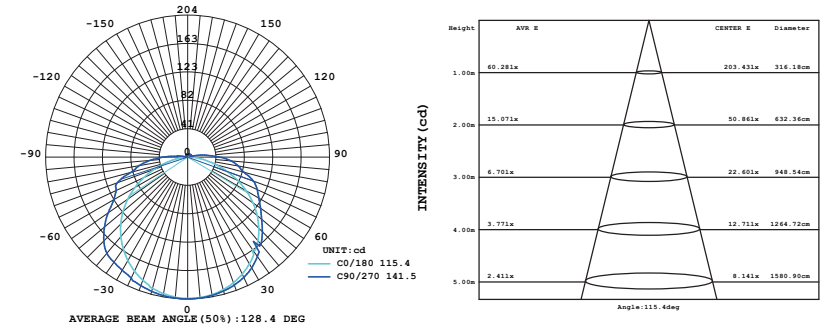

Photo-electric Parameters

	CCT (°K)	LM/M	LM/W	Energy Efficiency CLASS
>90(White)	2700K	805	75	/
	3000K	805	75	/
	4000K	845	79	/
>90(Black)	6000K	845	79	/
	2700K	700	69	/
	3000K	700	69	/
	4000K	735	72	/
	6000K	735	72	/

Recommended Accessories

Image	Code
	2PIN-18AWG
	Horizontal outlet cap & No wire end cap S0410
	V1+R6-1
	LRS-100-24



**90** COB2016NEON-24V-480D-8-68

**COB2016 480LEDs/M**

- Khun Easy to install and preserve.
- Our COB led strip is certified by CE ROHS.
- Apply environmental friendly material neon tube.
- Available with 2700K/3000K/4000K/6500K/R/G/B.
- No light dot, beautiful linear effect with big beam angle 180°.
- Adopt brand LED chip, achieving good quality and high brightness.

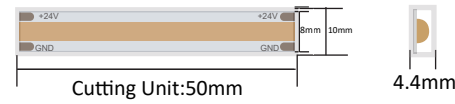
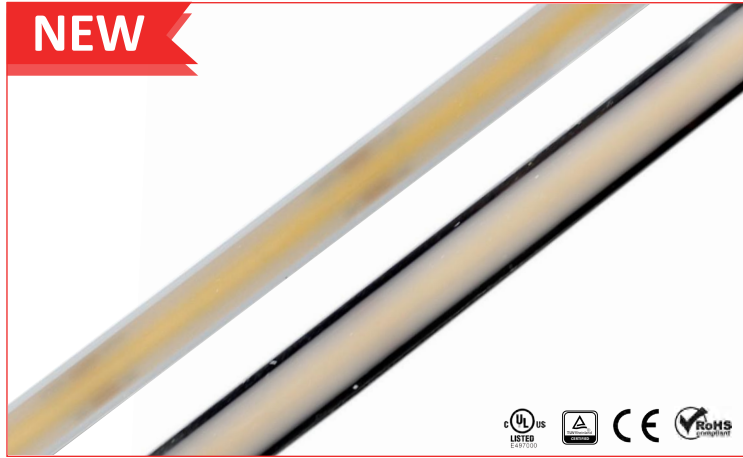

COB Dots free NEON TOP VIEW IP68 24V 8mm 5M REEL

**Basic Parameters**

Power	9W/m
Input Voltage	24VDC
Input Current	0.3699A/m
Cutting Unit	24LEDs/50mm
Neon Size	4x10mm
Bend Diameter	>60mm
Copper foil	2oz

**Luminous Intensity Distribution**

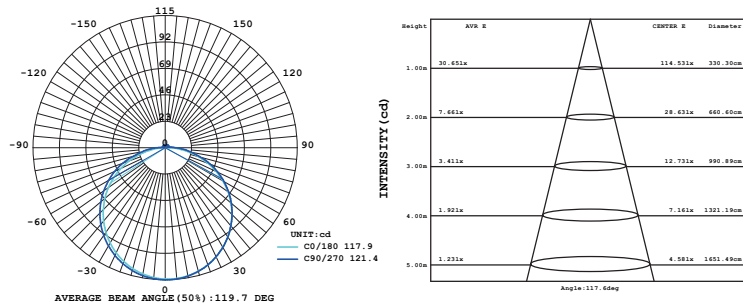

**Photo-electric Parameters**

	CCT (°K)	LM/M	LM/W	Energy Efficiency CLASS
>90(White)	2700K	589	66	/
	3000K	589	66	/
	4000K	618	69	/
	6000K	618	69	/
>90(Black)	2700K	397	43	/
	3000K	397	43	/
	4000K	378	45	/
	6000K	378	45	/

**Recommended Accessories**

Image				
Code	2PIN-18AWG	Horizontal outlet cap & No wire end cap S0410	V3+R8-1	LRS-75-24

**91** COB2016MC-12V-528D-8-20

**COB2016 528LEDs/M**

- Khun Easy to install and preserve;
- Our COB led strip is certified by CE ROHS;
- Available with 2700K/3000K/4000K/6500K/R/G/B;
- Anywhere cuttable, is more convenient for project using;
- No light dot, beautiful linear effect with big beam angle 180°;
- Adopt brand LED chip, achieving good quality and high brightness.



COB MINI CUT IP54 IP65 IP67 12V 8mm 5M REEL

**Basic Parameters**

Power	10W/m
Input Voltage	12VDC
Input Current	0.8150A/m
Cutting Unit	Anywhere Cuttable
Size	5000x8x1.8mm
Bend Diameter	>60mm
Copper foil	2oz

**Luminous Intensity Distribution**

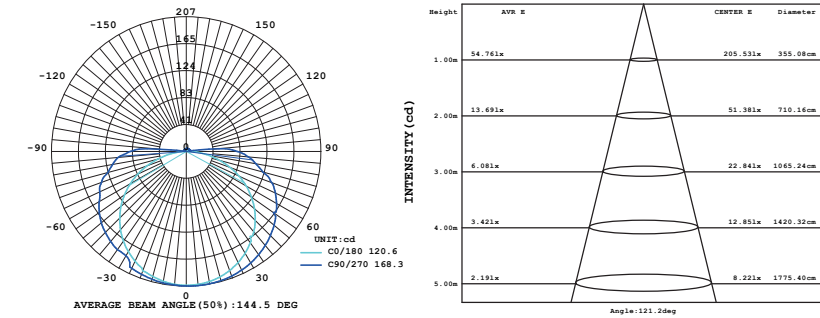

**Photo-electric Parameters**

	CCT (°K)	LM/M	LM/W	Energy Efficiency CLASS
>90	2700K	854	87	/
	3000K	854	87	/
	4000K	899	92	/
	6000K	899	92	/

**Recommended Accessories**

Image				
Code	2PIN-18AWG	HM-N8BB-2PIN	V1+R6-1	LRS-75-24

**92** COB2016SPIRGB-12V-630D-12-20

COB2016 630LEDs/M

- Khun Easy to install and preserve.
- Our COB led strip is certified by CE ROHS.
- No light dot, beautiful linear effect with big beam angle 180°.
- Adopt brand LED chip, achieving good quality and high brightness.
- RGB changeable color, ideal for residential and entertaining lighting.

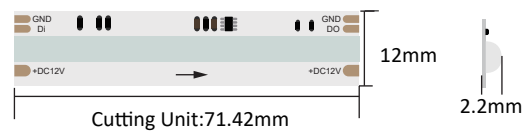

COB RGB SPI IP54 IP65 IP67 12V 12mm 5M REEL

Basic Parameters

Power	10W/m
Input Voltage	12VDC
Input Current	0.7904A/m
Cutting Unit	45LEDs/71.42mm
Size	5000x12x2.2mm
Bend Diameter	>60mm
Copper foil	2oz

Luminous Intensity Distribution

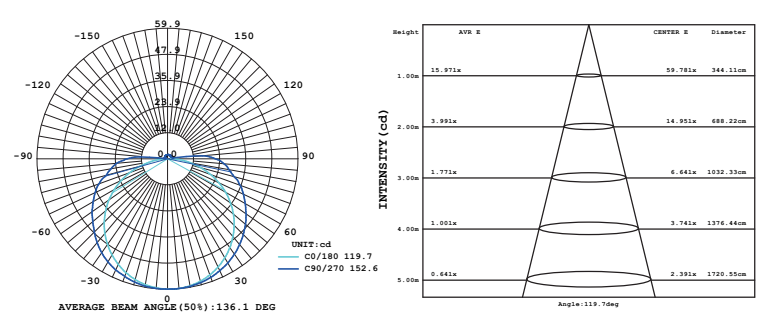

Photo-electric Parameters

COLOR	LM/M	LM/W
RGB	254	27

Recommended Accessories

Image			
Code	SC	R8-1	LRS-75-24

**93** COB2016SPIRGB-24V-630D-12-20

COB2016 630LEDs/M

- Khun Easy to install and preserve;
- Our COB led strip is certified by CE ROHS;
- Available with 2700K/3000K/4000K/6500K/R/G/B;
- No light dot, beautiful linear effect with big beam angle 180°;
- Adopt brand LED chip, achieving good quality and high brightness;
- RGB changeable color, ideal for residential and entertaining lighting.

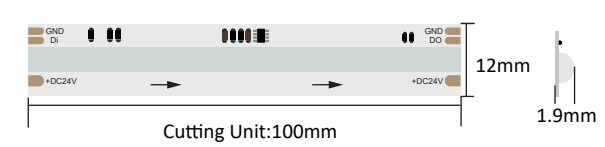

COB RGB SPI IP54 IP65 IP67 24V 12mm 5M REEL

Basic Parameters

Power	13W/m
Input Voltage	24VDC
Input Current	0.5147A/m
Cutting Unit	63LEDs/100mm
Size	5000x12x1.9mm
Bend Diameter	>60mm
Copper foil	2oz

Luminous Intensity Distribution

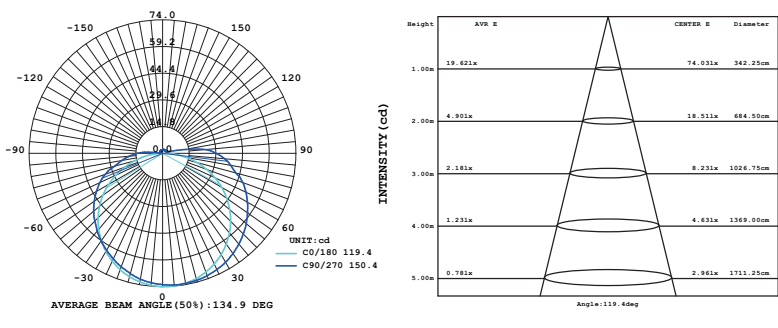

Photo-electric Parameters

COLOR	LM/M	LM/W
RGB	375	30

Recommended Accessories

Image			
Code	SC	R8-1	LRS-100-24



**94 COB2016CC-24V-504D-10-20**

COB2016 504LEDs/M

- Khun Controlled by constant current IC, is very stable.
- Single end power supply with 10m, no voltage drop.
- Good quality, high brightness and competitive price.

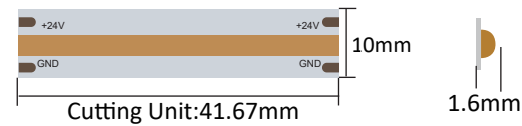

**NEW**

COB 10M RUN One Side IP54 IP65 IP67 24V 10 mm 5M REEL

Basic Parameters

Luminous Intensity Distribution

Power	11W/m
Input Voltage	24VDC
Input Current	0.4677A/m
Cutting Unit	21LEDs/41.67mm
Size	5000×10×1.6mm
Bend Diameter	> 60mm
Copper foil	2oz

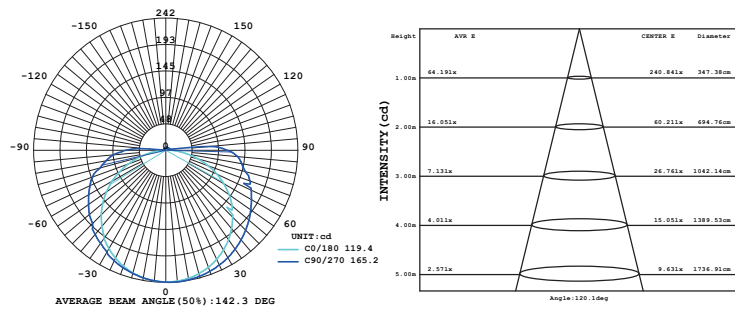

Photo-electric Parameters

	CCT (°K)	LM/M	LM/W	Energy Efficiency CLASS
>90	2700K	1067	92	/
	3000K	1067	92	/
	4000K	1120	97	/
	6000K	1120	97	/

Recommended Accessories

Image				
Code	2PIN-18AWG	HM-N10BB-2PIN	V1+R6-1	LRS-75-24

**95 COBD2016-24V-80D-8-20**

COBD2016 80LEDs/M

- Khun Cost-effective solutions with better prices.
- 2700K/3000K/4000K/6000K/RGB/TW optional.
- Apply high light chip to achieve good luminous efficiency.
- Higher heat conductivity for better thermal management.
- Better anti-bending capacity than normal COB LED Strip Light.



**NEW**

COB IP54 IP65 IP67 IP68 24V 8 mm 5M REEL

Basic Parameters

Luminous Intensity Distribution

Power	8W/m
Input Voltage	24VDC
Input Current	0.3473A/m
Cutting Unit	8LEDs/100mm
Size	5000×8×1.65mm
Bend Diameter	> 60mm
Copper foil	2oz

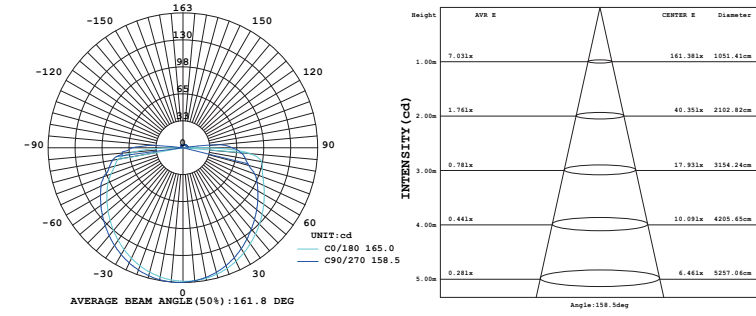

Photo-electric Parameters

	CCT (°K)	LM/M	LM/W	Energy Efficiency CLASS
>90	2700K	713	85	/
	3000K	713	85	/
	4000K	719	89	/
	6000K	719	89	/

Recommended Accessories

Image				
Code	2PIN-18AWG	HM-N8BB-2PIN	V1+R6-1	LRS-50-24

**96 COBD2016-24V-160D-8-20**

COBD2016 160LEDs/M

- Cost-effective solutions with better prices.
- 2700K/3000K/4000K/6000K/RGB/TW optional.
- Apply high light chip to achieve good luminous efficiency.
- Higher heat conductivity for better thermal management.
- Better anti-bending capacity than normal COB LED Strip Light.



**Basic Parameters**

Power	10W/m
Input Voltage	24VDC
Input Current	0.435A/m
Cutting Unit	8LEDs/50mm
Size	5000×8×1.65mm
Bend Diameter	>60mm
Copper foil	2oz

**Luminous Intensity Distribution**

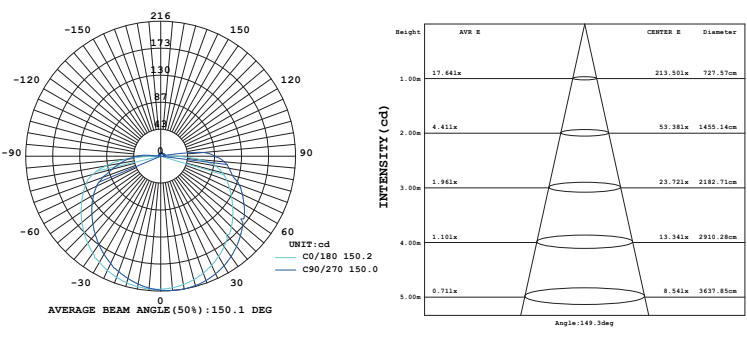

**Photo-electric Parameters**

	CCT (°K)	LM/M	LM/W	Energy Efficiency CLASS
>90	2700K	848	85	/
	3000K	848	85	/
	4000K	931	89	/
	6000K	931	89	/

**Recommended Accessories**



**97 COBD2016-24V-240D-8-20**

COBD2016 240LEDs/M

- Cost-effective solutions with better prices.
- 2700K/3000K/4000K/6000K/RGB/TW optional.
- Apply high light chip to achieve good luminous efficiency.
- Higher heat conductivity for better thermal management.
- Better anti-bending capacity than normal COB LED Strip Light.

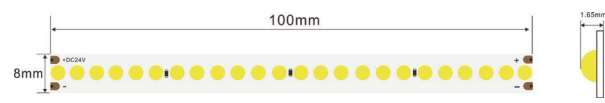

**Basic Parameters**

Power	12W/m
Input Voltage	24VDC
Input Current	0.5202A/m
Cutting Unit	24LEDs/100mm
Size	5000×8×1.65mm
Bend Diameter	>60mm
Copper foil	2oz

**Luminous Intensity Distribution**

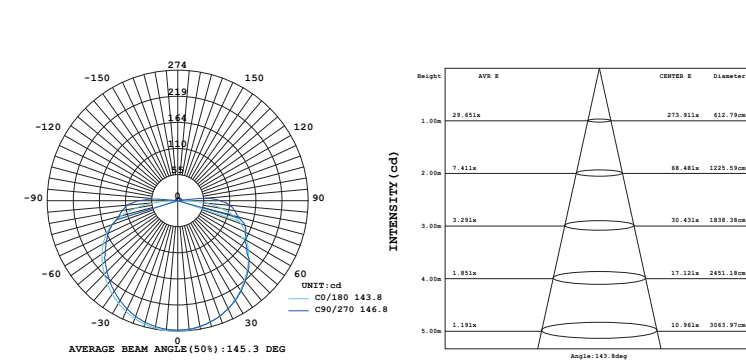

**Photo-electric Parameters**

	CCT (°K)	LM/M	LM/W	Energy Efficiency CLASS
>90	2700K	1071	89	/
	3000K	1071	89	/
	4000K	1170	94	/
	6000K	1170	94	/

**Recommended Accessories**





98 COBD2016CA-24V-160D-10-20

COB2016 160LEDs/M

- Adjustable from 2700K-6500K.
- Cost-effective solutions with better prices.
- Apply high light chip to achieve good luminous efficiency.
- Higher heat conductivity for better thermal management.
- Better anti-bending capacity than normal COB LED Strip Light.



Basic Parameters

Power	20W/m
Input Voltage	24VDC
Input Current	0.9617A/m
Cutting Unit	16LEDs/100mm
Size	5000×10×1.65mm
Bend Diameter	>60mm
Copper foil	2oz

Luminous Intensity Distribution

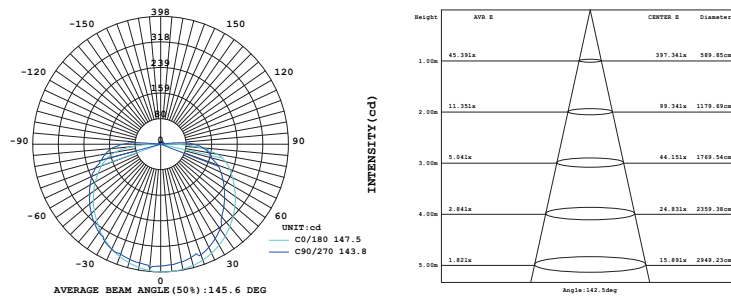

Photo-electric Parameters

CCT (°K)	LM/M	LM/W	Energy Efficiency CLASS
3000K	1443	72	/
4300K	1515	76	/
6500K	1571	78	/

Recommended Accessories

Image				
Code	3PIN-20AWG	HM-N10BB-2PIN	V3+R8-1	LRS-150-24

99 COBD2016RGB-24V-480D-10-20

COB2016 480LEDs/M

- Cost-effective solutions with better prices.
- 2700K/3000K/4000K/6000K/RGB/TW optional.
- Apply high light chip to achieve good luminous efficiency.
- Higher heat conductivity for better thermal management.
- Better anti-bending capacity than normal COB LED Strip Light.

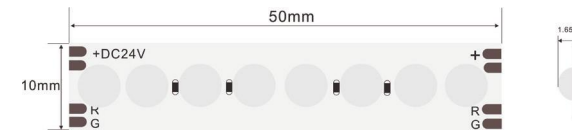

Basic Parameters

Power	15W/m
Input Voltage	24VDC
Input Current	0.6721A/m
Cutting Unit	8LEDs/50mm
Size	5000×10×1.65mm
Bend Diameter	>60mm
Copper foil	2oz

Luminous Intensity Distribution

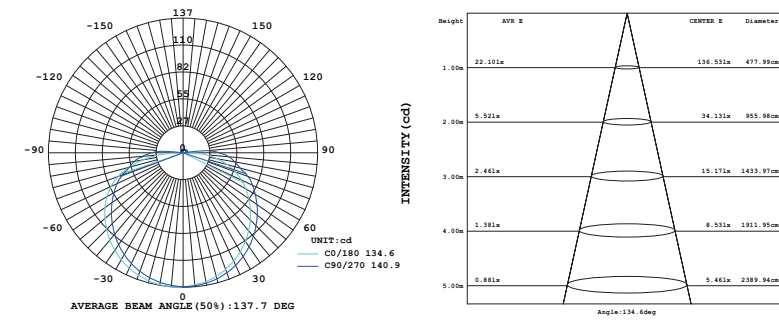

Photo-electric Parameters

COLOR	LM/M	LM/W
RGB	597	37

Recommended Accessories

Image				
Code	4PIN-20AWG	HM-N10BB-4PIN	V3+R8-1	LRS-100-24





## **Environmentally friendly silicone material**

### **Khun Neon Flex Strips**

"Top Bend ", "Side Bend", "3D series" and "360° Lighting".

Ip67&IP68 High Protection Level.

Can be used for sign lighting, indoor and outdoor decorative lighting and architecture contour lighting molding.



360° Round Series

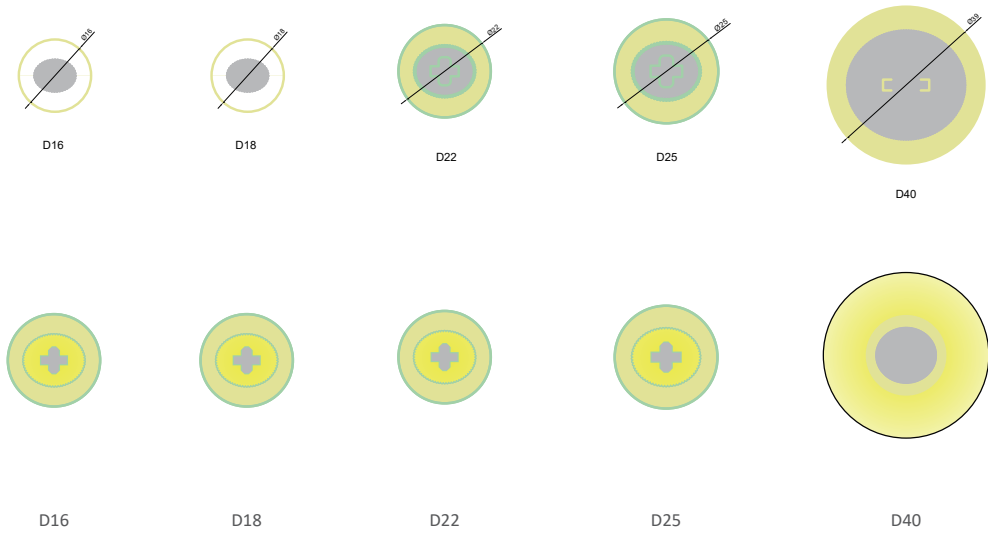

Side Bend Series



Extrusion Series



Top Bend Series





## 360° Khun Neon Flex series

Khun 360° Neon Flex series 360° light emission, no dark area.

Silicone material, match with different application solution to meet any molding needs, can be applied in straight line, circular, curved, and other special shape.



**100 D25P1-24V10-2835T-160D**

**D25 160LEDs/M**

- Khun 360° round light surface, uniform light, with dotless effect.
- High quality silicone, corrosion & acid & alkali resistance, anti-yellowing.
- Silicone extrusion process, IP67 protection level.
- Good flexibility, good bending, easy modeling and anti-pulling force.
- Applied for indoor&outdoor decorative lighting and architectural outline lighting etc.
- Provide Complete Accessory System for Vertical Ceiling, Suspended Ceiling, horizontal Lifting and other Creative Installations.

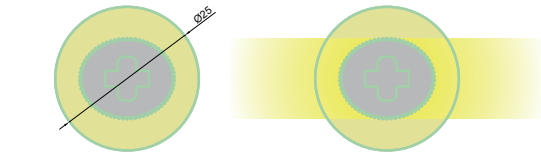

**Basic Parameters**

Power	20W/m
Input Voltage	24VDC
Input Current	0.681A/m
Cutting Unit	8LEDs/50mm
Diameter	25mm
Bend Diameter	>120mm
Copper foil	3oz

**Luminous Intensity Distribution**

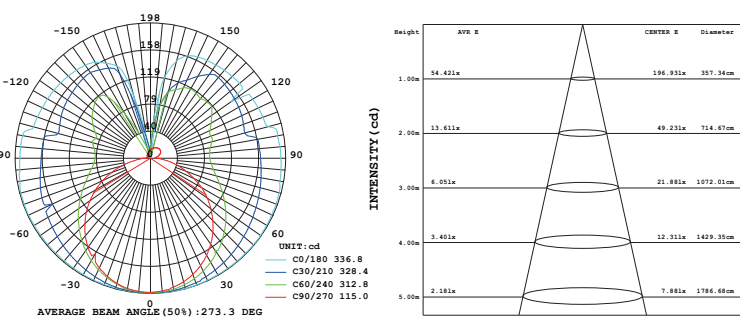

**Photo-electric Parameters**

CRI	CCT (°K)	LM/M	LM/W
>80	4000K	2079	103
	4000K(MINI)	1383	72
	RGBW	730	35
>90	2700K+6000K	1310	65
/	RGB	696	33

**Recommended Accessories**

Image	Code	Image	Code
	Silicone end cap with wire outlet D25		Flat end cap with wire outlet D25
	Silicone end cap without wire outlet D25		Flat end cap without wire outlet D25
	Silicone end cap with side wire outlet D25		PC clip D25
	Aluminium profile end cap with wire D25		PC Groove D25
	Aluminium profile end cap without wire D25		Stainless steel ring

**101 D22P1-24V08-2835T-160D**

**D22 160LEDs/M**

- Khun 360° round light surface, uniform light, with dotless effect.
- High quality silicone, corrosion & acid & alkali resistance, anti-yellowing.
- Silicone extrusion process, IP67 protection level.
- Good flexibility, good bending, easy modeling and anti-pulling force.
- Applied for indoor&outdoor decorative lighting and architectural outline lighting etc.
- Provide Complete Accessory System for Vertical Ceiling, Suspended Ceiling, horizontal Lifting and other Creative Installations.

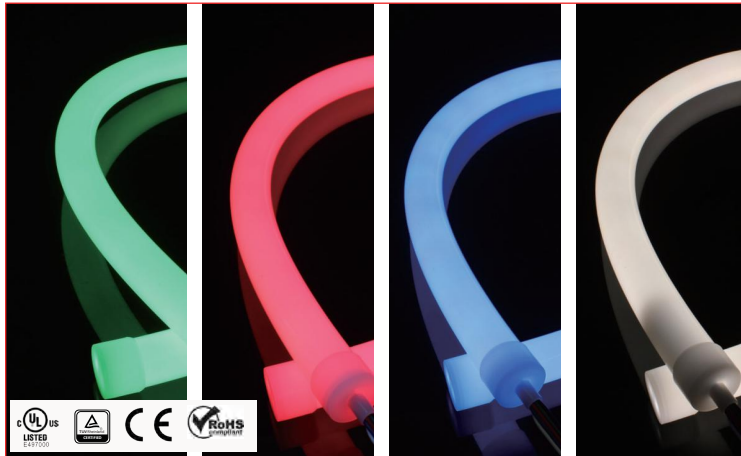

**Basic Parameters**

Power	20W/m
Input Voltage	24VDC
Input Current	0.814A/m
Cutting Unit	8LEDs/50mm
Diameter	22mm
Bend Diameter	>120mm
Copper foil	2oz/3oz

**Luminous Intensity Distribution**

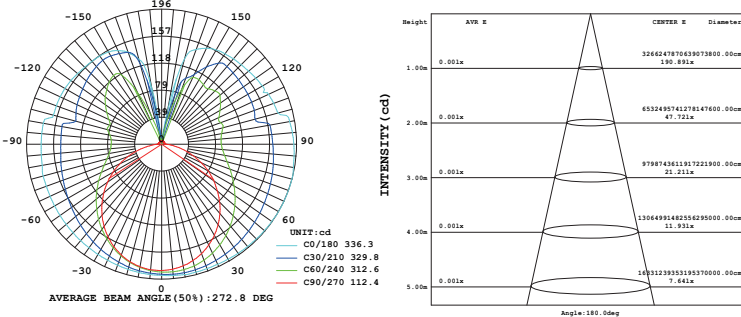

**Photo-electric Parameters**

CRI	CCT (°K)	LM/M	LM/W
>80	4000K	1688	86
	4000K(MINI)	1109	58
	2700K+6000K	1093	54
/	RGB	536	27

**Recommended Accessories**

Image	Code
	Silicone end cap with wire outlet D22
	Silicone end cap without wire outlet D22
	Aluminium profile end cap with wire D22
	Aluminium profile end cap without wire D22
	PC clip D22

## 102 D18P1-24V06-2835T-160D

### D18 160LEDs/M

- Khun 360° round light surface, uniform light, with dotless effect.
- High quality silicone, corrosion & acid & alkali resistance, anti-yellowing.
- Silicone extrusion process, IP67 protection level.
- Good flexibility, good bending, easy modeling and anti-pulling force.
- Applied for indoor&outdoor decorative lighting and architectural outline lighting etc.
- Provide Complete Accessory System for Vertical Ceiling, Suspended Ceiling, horizontal Lifting and other Creative Installations.



#### Basic Parameters

Power	20W/m
Input Voltage	24VDC
Input Current	0.833A/m
Cutting Unit	8LEDs/50mm
Diameter	18mm
Bend Diameter	>120mm
Copper foil	3oz

#### Luminous Intensity Distribution

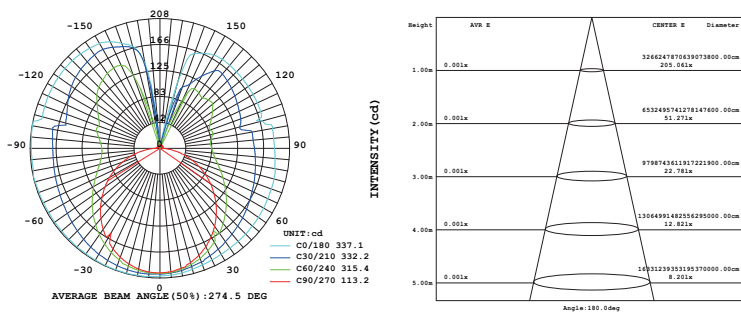

#### Photo-electric Parameters

CRI	CCT (°K)	LM/M	LM/W
>80	4000K	2311	115
	4000K(MINI)	1564	78

#### Recommended Accessories

Image	Code
	Silicone end cap with wire outlet D18
	Silicone end cap without wire outlet D18
	PC clip D18
	PC Groove D18

## 103 D16P1-24V05-2835T-210D

### D16 210LEDs/M

- Khun 360° round light surface, uniform light, with dotless effect.
- High quality silicone, corrosion & acid & alkali resistance, anti-yellowing.
- Silicone extrusion process, IP67 protection level.
- Good flexibility, good bending, easy modeling and anti-pulling force.
- Applied for indoor&outdoor decorative lighting and architectural outline lighting etc.
- Provide Complete Accessory System for Vertical Ceiling, Suspended Ceiling, horizontal Lifting and other Creative Installations.

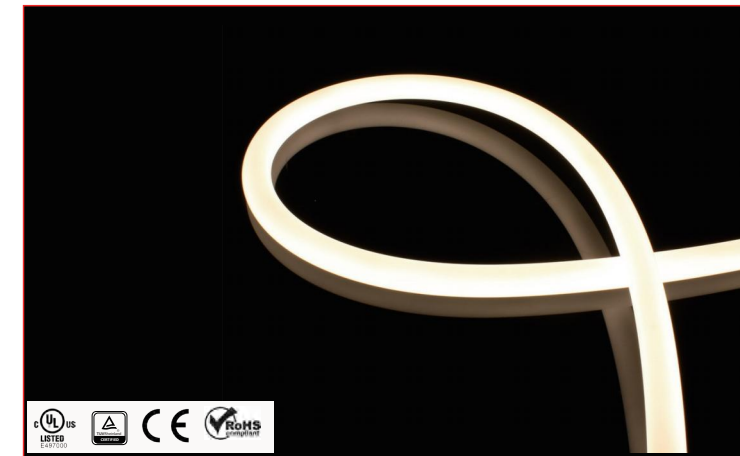

#### Basic Parameters

Power	20W/m
Input Voltage	24VDC
Input Current	0.833A/m
Cutting Unit	7LEDs/33.33mm
Diameter	16mm
Bend Diameter	>120mm
Copper foil	2oz/3oz

#### Luminous Intensity Distribution

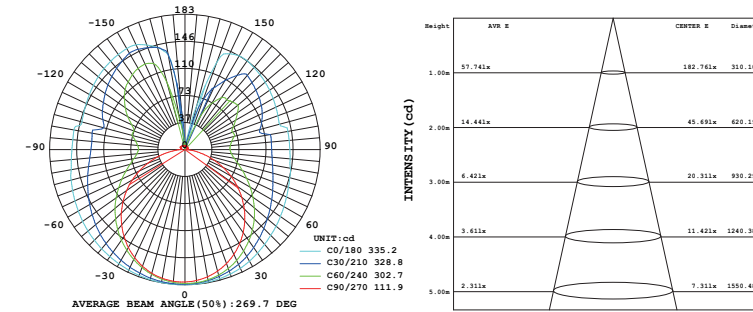

#### Photo-electric Parameters

CRI	CCT (°K)	LM/M	LM/W
>80	4000K	1964	98
	4000K(MINI)	2224	111

#### Recommended Accessories

Image	Code
	Silicone end cap with wire outlet D16
	Silicone end cap without wire outlet D16
	PC clip D16





## Khun 3D Series

Khun 3D series neon adopt flexible silicone material, strong plasticity, combined with top-bend, side-bend two type lighting surfaces, and the matched installation solution, meets the needs of multiple lighting.



**104 3D1616-24V06-2835T-160D**

**3D-1616 160LEDs/M**

- Khun 3D series neon, adopt flexible silicone material, strong plasticity, top-bend and side-bend.
- High quality silicone, corrosion & acid & alkali resistance, anti-yellowing.
- Good flexibility, good bending, easy modeling and anti-pulling force.
- Silicone extrusion process, IP67 protection level.
- Applied for indoor&outdoor decorative lighting and architectural outline lighting etc.

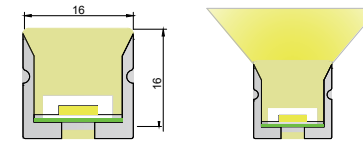

**Basic Parameters**

Power	8W/m
Input Voltage	24VDC
Input Current	0.33A/m
Cutting Unit	8LEDs/50mm
Size	5000×16×16mm
Bend Diameter	> 60mm
Copper foil	2oz

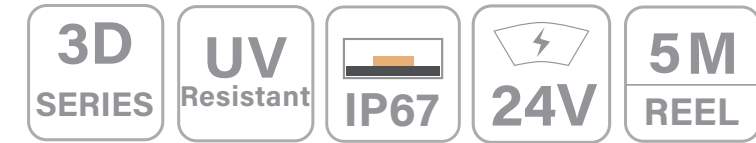
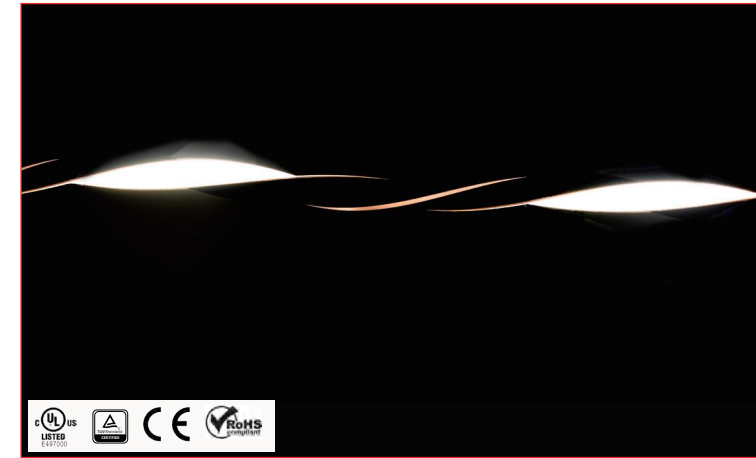

**Luminous Intensity Distribution**

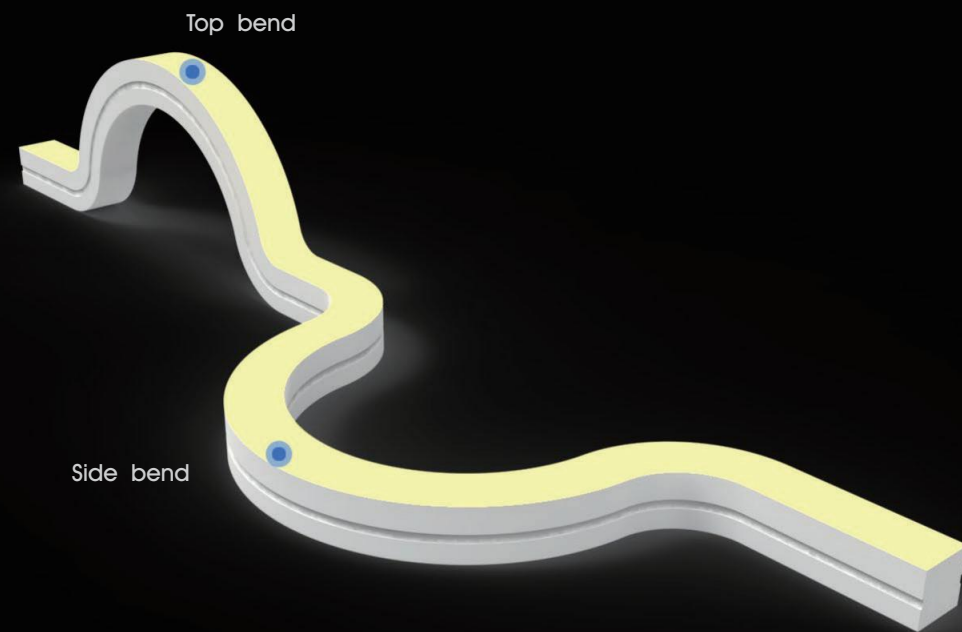
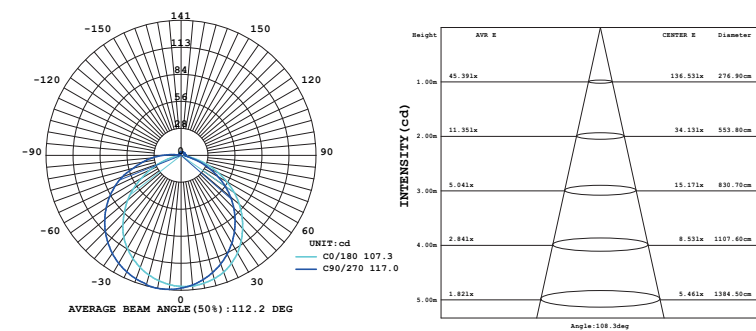

**Photo-electric Parameters**

CRI	CCT (°K)	LM/M	LM/W
>80	2700K	593	72
	3000K	593	72
	4000K	625	76
>90	6000K	625	76
	2700K	534	64
	3000K	534	64
	4000K	562	68
	6000K	562	68

**Recommended Accessories**

Image	Code	Image	Code
	PC clip 3D1616		Horizontal outlet cap & No wire end cap 3D1616
	PC groove 3D1616		
	Aluminum alloy clip 3D1616		
	Flat mounting aluminum groove 3D1616		
	Stainless steel S-shaped buckle belt		





## Khun IP68 270° large luminous Surface

270°dome structure design, large luminous surface and homogeneous light.  
Ik08, IP68, able to be used in soaking environment.  
Systematized solution of installation.

# IP68 270° LARGE LUMINOUS SURFACE

## 105 1225-24V10-2835S-120D-IP68

1225 120LEDs/M

- Khun Mushroom head shape, 270° wide beam angle, with high efficiency light.
- Silicone extrusion process, IP68 protection level.
- High quality silicone, corrosion & acid & alkali resistance, anti-yellowing.
- Good flexibility, good bending, easy modeling and anti-pulling force.
- Applied for indoor&outdoor decorative lighting and architectural outline lighting etc.

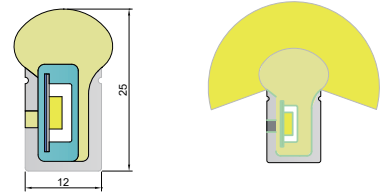

### Basic Parameters

Typ. Power	10W/m
Input Voltage	24VDC
Input Current	0.417A/m
Cutting Unit	6LEDs/50mm
Size	5000×12×25mm
Bend Diameter	>60mm
Copper foil	2oz/3oz

### Luminous Intensity Distribution

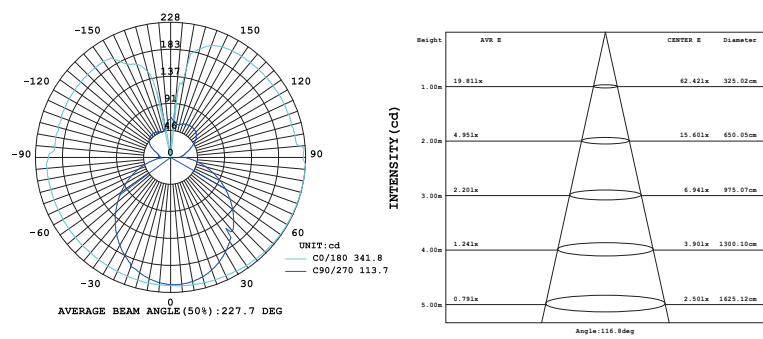

### Photo-electric Parameters

CRI	CCT (°K)	LM/M	LM/W
>80	2700K	427	41
	3000K	427	41
	4000K	540	44
	6000K	540	44
>90	2700K	384	37
	3000K	384	37
	4000K	405	39
	6000K	405	39

### Recommended Accessories

Image	Code	Image	Code
	Side outlet cap & Horizontal outlet cap S1225		Stainless steel S-shaped buckle belt S1225
	No wire end cap S1225		Aluminum alloy clip S1225
	Stainless steel clip S1225		Flat mounting aluminum groove S1225
	Stainless steel round hoop		Catapult clip S1225
	Straight buckle belt S1225		

# IP68 120° LUMINOUS SURFACE

## 106 1616-24V10-2835T-120D-IP68

1616 120LEDs/M

- Khun Silicone extrusion process, IP68 protection level;
- High quality silicone, corrosion & acid & alkali resistance, anti-yellowing.
- Good flexibility, good bending, easy modeling and anti-pulling force.
- Applied for indoor&outdoor decorative lighting and architectural outline lighting etc.

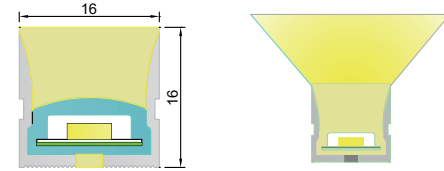

### Basic Parameters

Typ. Power	10W/m
Input Voltage	24VDC
Input Current	0.417A/m
Cutting Unit	6LEDs/50mm
Size	5000×16×16mm
Bend Diameter	>60mm
Copper foil	2oz

### Luminous Intensity Distribution

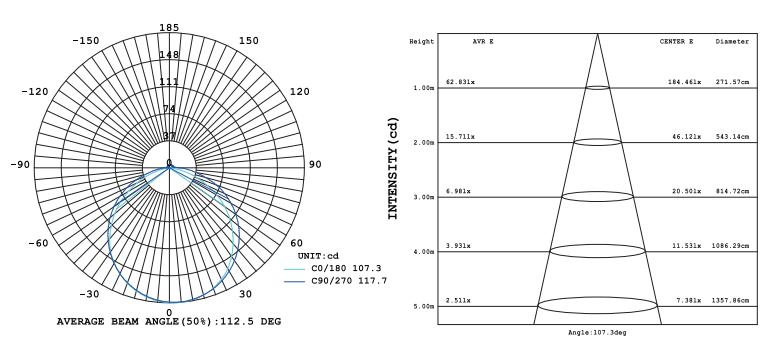

### Photo-electric Parameters

CRI	CCT (°K)	LM/M	LM/W
>80	2700K	534	52
	3000K	534	52
	4000K	563	55
	6000K	563	55
>90	2700K	480	46
	3000K	480	46
	4000K	506	49
	6000K	506	49

### Recommended Accessories

Image	Code	Image	Code
	Side outlet cap & Bottom outlet cap T1616		Aluminum alloy clip T1616
	Horizontal outlet cap & No wire end cap T1616		Flat mounting aluminum groove T1616
	Stainless steel round hoop		PC clip D25
	Stainless steel clip T1616		
	Straight buckle belt T1616		



**107 0410-24V06-2835S-160D**

**0410 160LEDs/M**

- Khun Small size, 04\*10mm, dot-free illumination;
- High quality silicone, corrosion & acid & alkali resistance, anti-yellowing.
- Good flexibility, good bending, easy modeling and anti-pulling force.
- Silicone extrusion process, IP67 protection level.
- Applied for indoor&outdoor decorative lighting and architectural outline lighting etc.

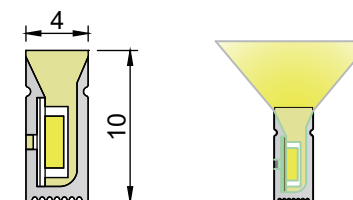

Side View

Small Size

UV Resistant

IP67

24V

5M REEL

**Basic Parameters**

Power	8W/m
Input Voltage	24VDC
Input Current	0.33A/m
Cutting Unit	8LEDs/50mm
Size	5000x04x10mm
Bend Diameter	>60mm
Copper foil	2oz

**Luminous Intensity Distribution**

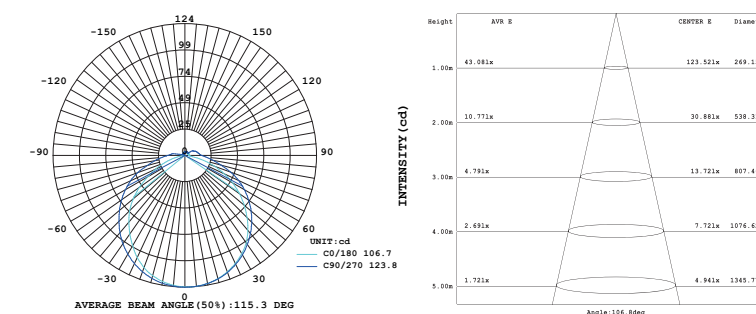
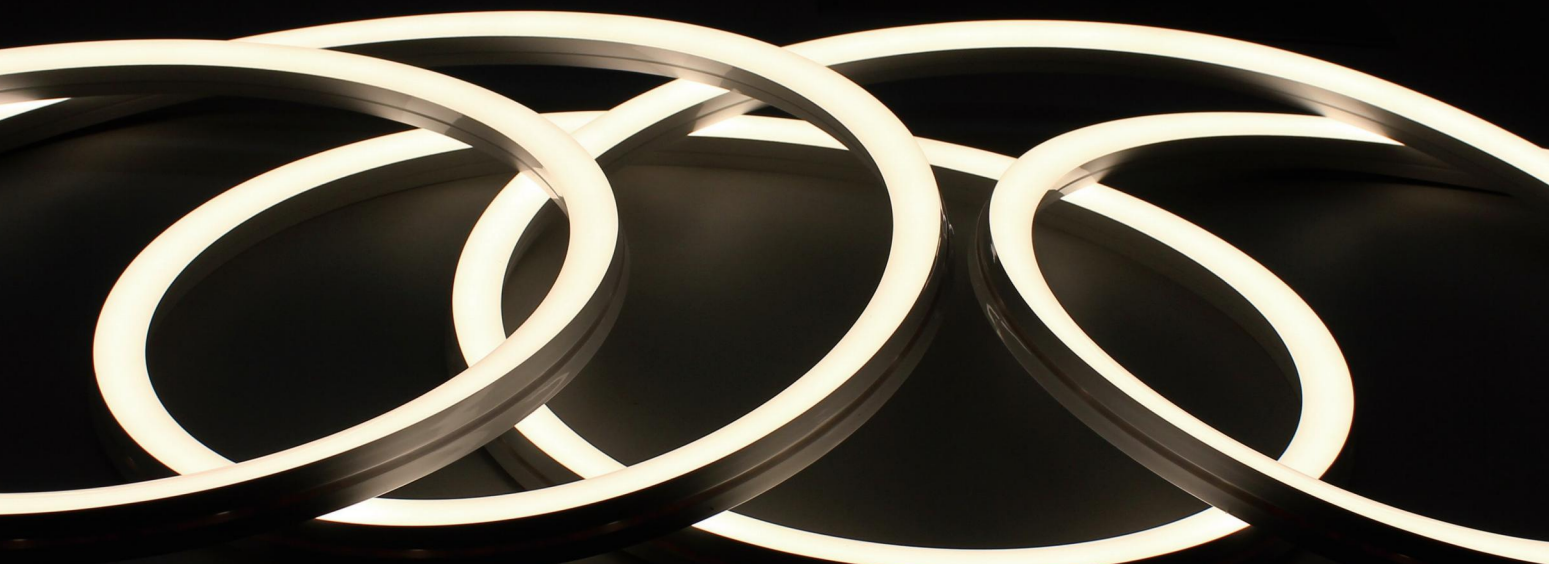

**Photo-electric Parameters**

CRI	CCT (°K)	LM/M	LM/W
>80	2700K	404	49
	3000K	404	49
	4000K	426	52
>90	6000K	426	52
	2700K	363	43
	3000K	363	43
>90	4000K	383	46
	6000K	383	46

**Recommended Accessories**

Image	Code	Image	Code
	Horizontal outlet cap & No wire end cap S0410		Stainless steel S-shaped buckle belt S0410
	Stainless steel round hoop		Flat mounting aluminum groove S0410
	Stainless steel clip S0410		



**Khun Side Bend Series**

Side bend series neon adopt unique optical structure design, uniform light and no shadow. Side-bending design can be used for building outline, indoor and outdoor decorative lighting and other scenes.

**108** 0613-24V08-2835S-120D

0613 120LEDs/M

- Khun Mushroom head shape, 180° wide beam angle, with high efficiency light.
- High quality silicone, corrosion & acid & alkali resistance, anti-yellowing.
- Good flexibility, good bending, easy modeling and anti-pulling force.
- Silicone extrusion process, IP67 protection level.
- Applied for indoor&outdoor decorative lighting and architectural outline lighting etc.

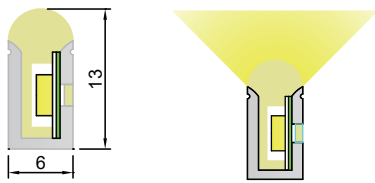

Basic Parameters

Typ. Power	10W/m
Input Voltage	24VDC
Input Current	0.417A/m
Cutting Unit	6LEDs/50mm
Size	5000×6×13mm
Bend Diameter	>60mm
Copper foil	2oz/3oz

Luminous Intensity Distribution

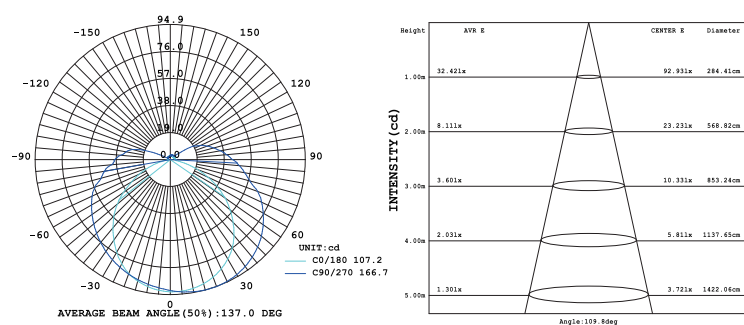

Photo-electric Parameters

CRI	CCT (°K)	LM/M	LM/W
>80	2700K	411	40
	3000K	411	40
	4000K	433	42
>90	6000K	433	42
	2700K	369	35
	3000K	369	35
	4000K	389	37
	6000K	389	37

Recommended Accessories

Image	Code	Image	Code
	Horizontal outlet cap& No wire end cap S0613		Stainless steel S-shaped buckle belt S0613
	Stainless steel clip S0613		Aluminum alloy clip S0613
	Stainless steel round hoop		Flat mounting aluminum groove S0613

**109** 1022-24V10-2835S-120D

1022 120LEDs/M

- Khun Mushroom head shape, 270° wide beam angle, with high efficiency light.
- High quality silicone, corrosion & acid & alkali resistance, anti-yellowing.
- Good flexibility, good bending, easy modeling and anti-pulling force.
- Silicone extrusion process, IP67 protection level.
- Applied for indoor&outdoor decorative lighting and architectural outline lighting etc.

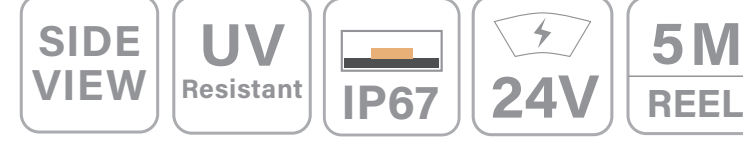
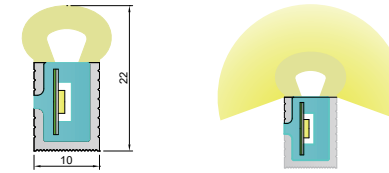

Basic Parameters

Typ. Power	10W/m
Input Voltage	24VDC
Input Current	0.417A/m
Cutting Unit	6LEDs/50mm
Size	5000×10×22mm
Bend Diameter	>60mm
Copper foil	2oz/3oz

Luminous Intensity Distribution

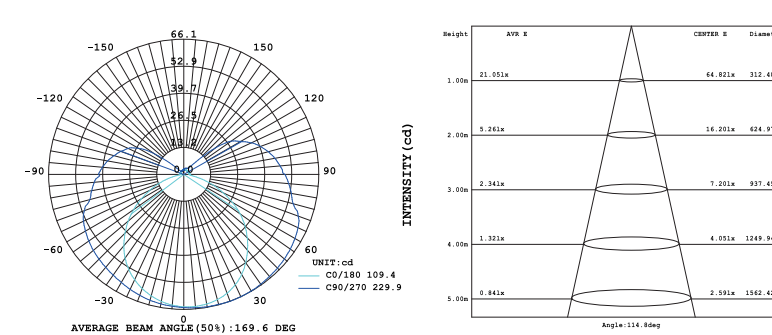

Photo-electric Parameters

CRI	CCT (°K)	LM/M	LM/W
>80	2700K	379	36
	3000K	379	36
	4000K	399	38
>90	6000K	399	38
	2700K	341	32
	3000K	341	32
	4000K	359	34
	6000K	359	34

Recommended Accessories

Image	Code	Image	Code
	Wire solderless terminal S1022		Stainless steel clip S1022
	Butt solderless terminal S1022		Straight buckle belt S1022
	Grounding welding-free connection terminal S1022		Stainless steel S-shaped buckle belt S1022
	Butt solderless terminal S1022		Catapult clip S1022
	Side outlet cap S1022		Aluminum alloy clip S1022
	Horizontal outlet cap & No wire end cap S1022		Flat mounting aluminum groove S1022





## Khun Top Bend Series

Top bend series neon flex adopt environmental silicone material, up to IP67 protection level, even if used outdoor for a long time, the surface will not turn yellow easily.

**110 1715-24V10-2835T-120D**

1715 120LEDs/M

- Khun Mushroom head shape, 180° wide beam angle, with high efficiency light.
- High quality silicone, corrosion & acid & alkali resistance, anti-yellowing.
- Good flexibility, good bending, easy modeling and anti-pulling force.
- Silicone extrusion process, IP67 protection level.
- Applied for indoor&outdoor decorative lighting and architectural outline lighting etc.

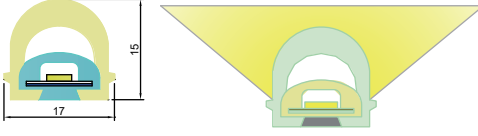
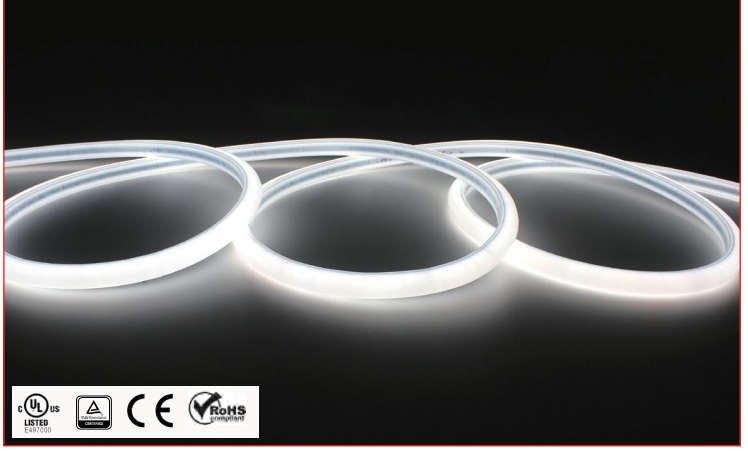

**Basic Parameters**

Typ. Power	10W/m
Input Voltage	24VDC
Input Current	0.417A/m
Cutting Unit	6LEDs/50mm
Size	5000×17×15mm
Bend Diameter	>60mm
Copper foil	2oz/3oz

**Luminous Intensity Distribution**

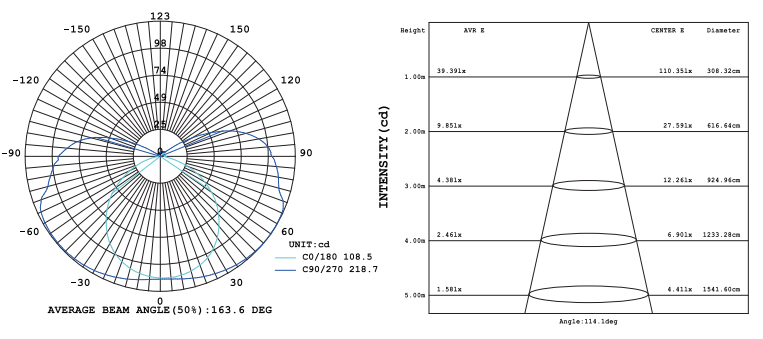

**Photo-electric Parameters**

CRI	CCT (°K)	LM/M	LM/W
>80	2700K	810	78
	3000K	810	78
	4000K	853	83
	6000K	853	83
>90	2700K	728	70
	3000K	728	70
	4000K	767	74
	6000K	767	74

**Recommended Accessories**

Image	Code	Image	Code
	Wiring connector (no welding)		End Cap without line
	Joint connector (no welding)		Round hoop
	Electric connector with line (no welding)		PC transparent fix clip
	Joint connector with line (no welding)		Linear PC transparent fix lip(one meter)
	End Cap with left line		Aluminum alloy buckle
	End Cap with right line		Aluminum alloy buckle (one meter)

**111 1010-24V08-2835T-140D**

1010 140LEDs/M

- Khun 10mm width flat luminous surface.
- High quality silicone, corrosion & acid & alkali resistance, anti-yellowing.
- Good flexibility, good bending, easy modeling and anti-pulling force.
- Silicone extrusion process, IP67 protection level.
- Applied for indoor&outdoor decorative lighting and architectural outline lighting etc.

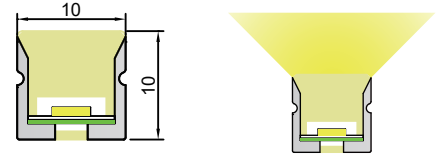

**Basic Parameters**

Typ. Power	10W/m
Input Voltage	24VDC
Input Current	0.147A/m
Cutting Unit	7LEDs/50mm
Size	5000×10×10mm
Bend Diameter	>60mm
Copper foil	2oz/ 3oz

**Luminous Intensity Distribution**

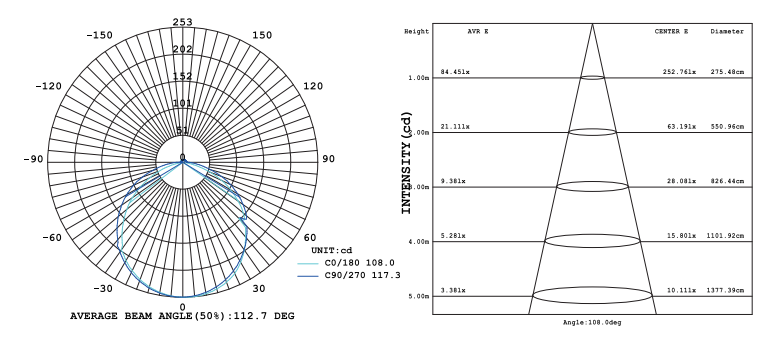

**Photo-electric Parameters**

CRI	CCT (°K)	LM/M	LM/W
>80	2700K	740	74
	3000K	740	74
	4000K	780	78
	6000K	780	78
>90	2700K	600	60
	3000K	600	60
	4000K	650	65
	6000K	650	65

**Recommended Accessories**

Image	Code	Image	Code
	Silicone End Cap with side Line		Round hoop
	Silicone End Cap horizontal direction with Line		Linear buckle belt (one meter per group)
	Silicone End Cap with bottom Line		Aluminum alloy buckle
	Silicone End Cap without Line		Aluminum alloy buckle (one meter)
	Stainless fix clip		



# Khun LED Panel Flex

Cut out any design you want

Single Color/Dual color/Multi-color/Digital optional;  
Suitable for advertisements/counter/bar tops/curved surfaces etc.

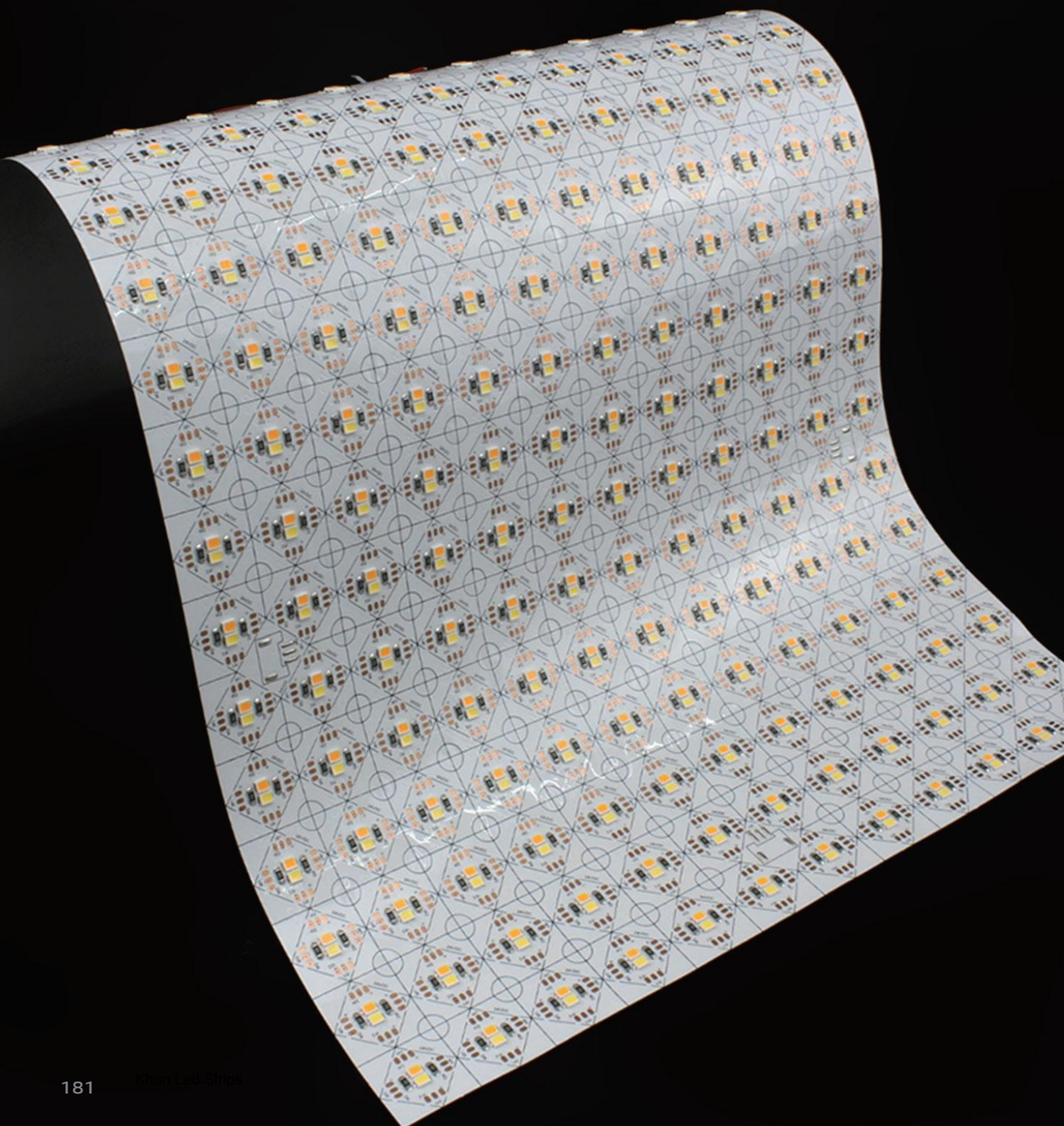

## 112 PL2835-24V-288D-20

2835 288LEDS/PCS

- Ideally suitable for advertisements, counter and bar tops, curved surfaces, low clearance applications.
- With high density 2835 led source, are specifically engineered to be dimmable.
- Easily and quickly without soldering. Can be cut every one led, allows for non-site customization which can eliminate custom order lead times.

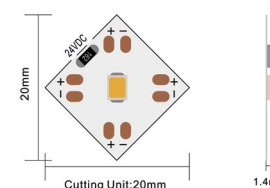

**ONE LED**

**IP54**

**24V**

**480\*240 mm**

**1 PCS Package**

### Basic Parameters

Power	30W/PCS
Input Voltage	24VDC
Input Current	1.25A/PCS
Cutting Unit	20*20mm
Size	480x240x1.4mm
Bend Diameter	>60mm
Copper foil	2oz

### Luminous Intensity Distribution

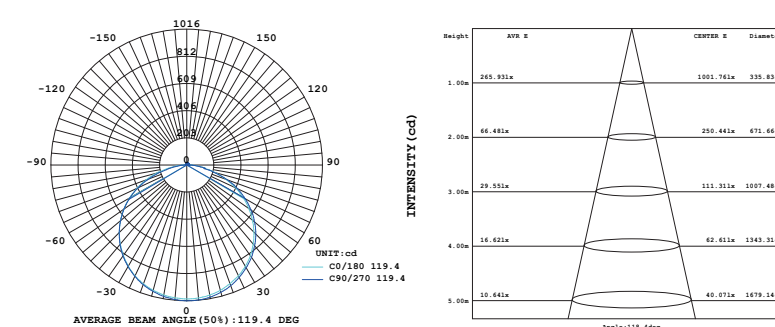

### Photo-electric Parameters

	CCT (°K)	LM/M	LM/W
>80	2700K	2839	96
	3000K	2839	96
	4000K	3219	101
	6000K	3219	101

### Recommended Accessories

Image			
Code	2PIN-18AWG	V1+R6-1	LRS-50-24



## 113 PL6060-24V-288D-20

6060 288LEDS/PCS

- Khun Ideally suitable for advertisements, counter and bar tops, curved surfaces, low clearance applications.
- Large size 6060 led source combined with lens, light-emitting angle reaches 160° with uniform illumination. It's specifically engineered to be a dimmable and field customized solution.
- Easily and quickly without soldering. Can be bent and cut into virtually any shape, allows for non-site customization which can eliminate custom order lead time.



With Lens IP54 24V 480\*240 mm 1 PCS Package

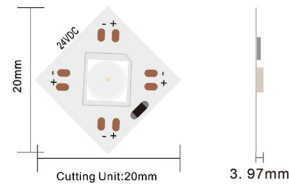

### Basic Parameters

Power	35W/PCS
Input Voltage	24VDC
Input Current	1.46A/PCS
Cutting Unit	20*20mm
Size	480x240x3.97mm
Bend Diameter	>60mm
Copper foil	2oz

### Luminous Intensity Distribution

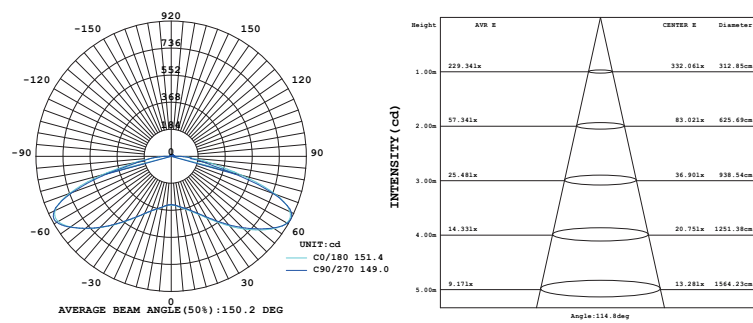

### Photo-electric Parameters

	CCT (°K)	LM/M	LM/W
>80	2700K	3272	93
	3000K	3272	93
	4000K	3365	98
	6000K	3365	98

### Recommended Accessories

Image			
Code	2PIN-18AWG	V1+R6-1	LRS-50-24

## 114 PL2835TW-24V-576D-20

2835 576LEDS/PCS

- Khun Ideally suitable for advertisements, counter and bar tops, curved surfaces, low clearance applications.
- Apply SMD 2835 light source, dual color adjustable at 1800K-6500K.
- Easily and quickly without soldering. Can be bent and cut into virtually any shape, allows for non-site customization which can eliminate custom order lead time.



Dual Color IP54 24V 480\*240 mm 1 PCS Package

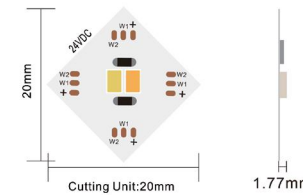

### Basic Parameters

Power	36W/PCS
Input Voltage	24VDC
Input Current	1.5A/PCS
Cutting Unit	20*20mm
Size	480x240x1.77mm
Bend Diameter	>60mm
Copper foil	2oz

### Luminous Intensity Distribution

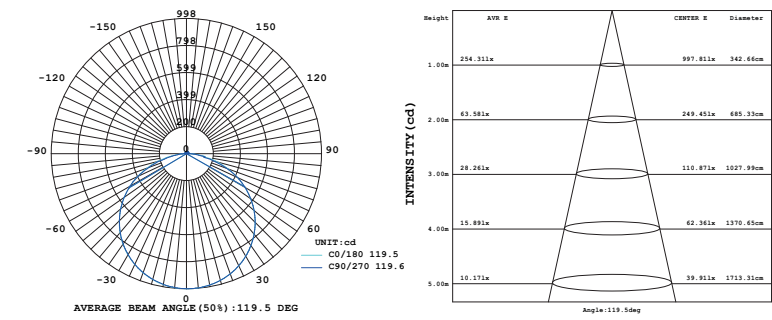

### Photo-electric Parameters

	CCT (°K)	LM/M	LM/W
	1800K	1275	70
	3500K	2895	79
	6500K	1680	92

### Recommended Accessories

Image			
Code	3PIN-18AWG	V2+R7	LRS-50-24



**115 PL5050RGB-24V-288D-20**

5050 288LEDS/PCS

- Ideally suitable for advertisements, backlighting, counter and bar tops.
- With 5050 RGB led source, high density, panel flex are specifically engineered to be dimmable, field customizable solution.
- Easily and quickly without soldering, can be cut every 12 leds.

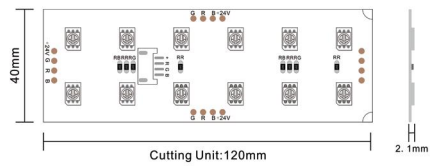

**RGB** **IP54** **24V** **480\*240 mm** **1 PCS Package**

**Basic Parameters**

Power	55W/PCS
Input Voltage	24VDC
Input Current	2.31A/PCS
Cutting Unit	40*120mm
Size	480×240×2.1mm
Bend Diameter	>60mm
Copper foil	2oz

**Luminous Intensity Distribution**

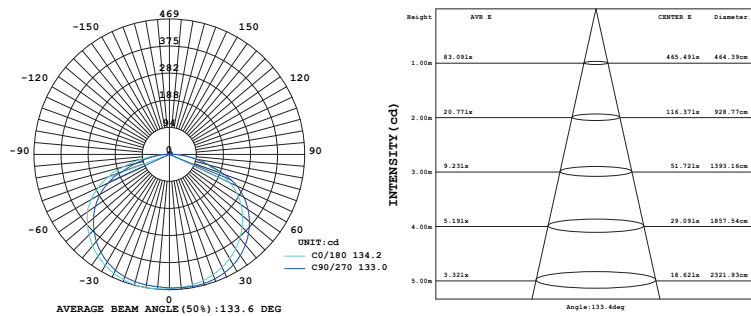

**Photo-electric Parameters**

COLOR	LM/M	LM/W
RGB <span style="color:red">■</span> <span style="color:green">■</span> <span style="color:blue">■</span>	1543	27

**Recommended Accessories**

Image			
Code	4PIN-20AWG	V3+R8-1	LRS-75-24

**116 PL5050RGBW-24V-288D-20**

5050 288LEDS/PCS

- Suitable for advertisements, counter and bar tops, curved surfaces, low clearance applications etc.
- With high output 5050 RGBW 4 in 1 chip, panel flex are specifically engineered to be dimmable, field customizable solution and around curvilinear shapes.
- Easily and quickly without soldering. It allows non-site customization which can eliminate custom order lead times.

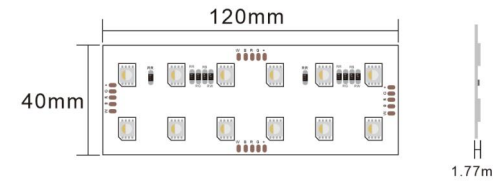
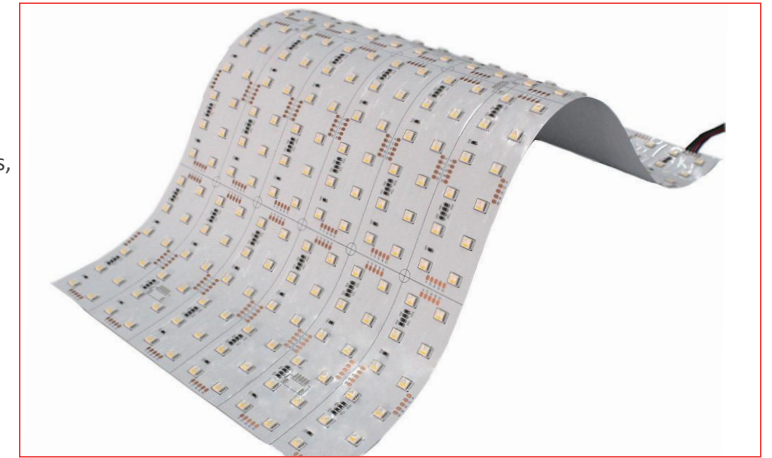

**RGBW** **IP54** **24V** **480\*240 mm** **1 PCS Package**

**Basic Parameters**

Power	60W/PCS
Input Voltage	24VDC
Input Current	2.5A/PCS
Cutting Unit	40*120mm
Size	480×240×1.77mm
Bend Diameter	>60mm
Copper foil	2oz

**Luminous Intensity Distribution**

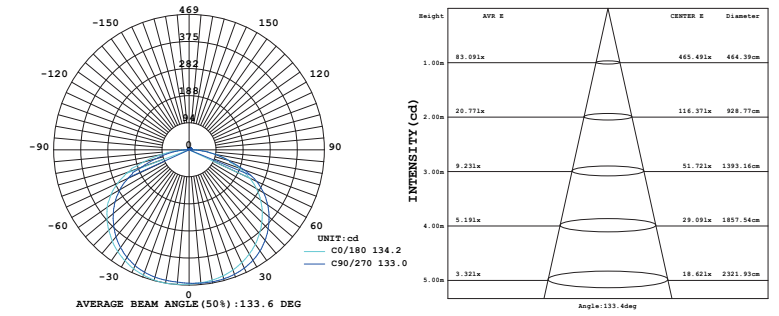

**Photo-electric Parameters**

	CCT (°K)	LM/M	LM/W
>80	RGBW( 2700K) <span style="color:red">■</span> <span style="color:green">■</span> <span style="color:blue">■</span> <span style="color:orange">■</span>	3240	54
	RGBW( 3000K) <span style="color:red">■</span> <span style="color:green">■</span> <span style="color:blue">■</span> <span style="color:orange">■</span>	3240	54
	RGBW( 4000K) <span style="color:red">■</span> <span style="color:green">■</span> <span style="color:blue">■</span> <span style="color:orange">■</span>	3559	57
	RGBW( 6000K) <span style="color:red">■</span> <span style="color:green">■</span> <span style="color:blue">■</span> <span style="color:lightblue">■</span>	3559	57

**Recommended Accessories**

Image			
Code	5PIN-20AWG	V3+R8-1	LRS-100-24

**117 PL5050RGBWW-24V-288-20**

5050 288LEDS/PCS

- Suitable for advertisements, counter and bar tops, curved surfaces, low clearance applications and situations where exact measurements are not known or likely to change.
- With high output SMD5050 RGBWW 5 in 1 chip, panel flex are specifically engineered to be dimmable, field customizable solution and around curvilinear shapes.
- Easily and quickly without soldering. It allows non-site customization which can eliminate custom order lead times.

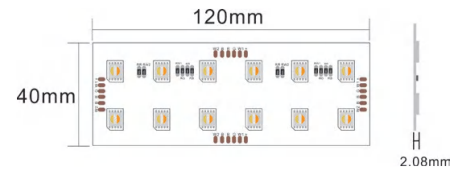

RGB CCT IP54 24V 480\*240 mm 1 PCS Package

**Basic Parameters**

Power	70W/PCS
Input Voltage	24VDC
Input Current	2.989A/PCS
Cutting Unit	40*120mm
Size	480*240*2.08mm
Bend Diameter	>60mm
Copper foil	2oz

**Luminous Intensity Distribution**

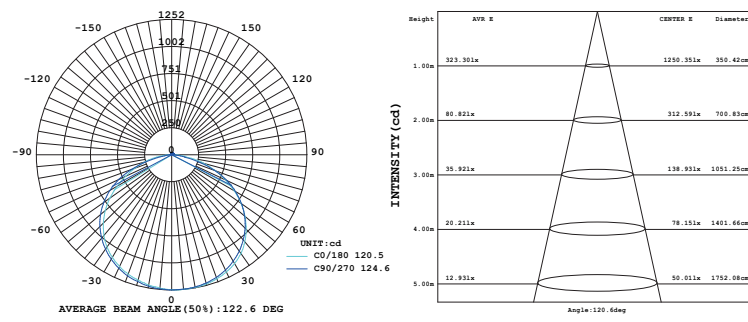

**Photo-electric Parameters**

	CCT (°K)	LM/M	LM/W
>80	1800K+6500K <span style="color:red">■</span> <span style="color:green">■</span> <span style="color:blue">■</span>	3994	55

**Recommended Accessories**

Image			
Code	6PIN-20AWG	V5+M+R17	LRS-100-24

**118 PL5050SPIRGB-24V-288D-20**

5050 288LEDS/PCS

- Suitable for advertisements, counter and bar tops, curved surfaces, low clearance applications, etc.
- With TM1923IC and high output 5050 RGB LED source, SPI digital panel flex are specifically engineered to be dimmable, field customizable solution and around curvilinear shapes.
- Easily and quickly without soldering. It allows non-site customization which can eliminate custom order lead times.

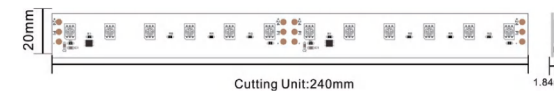
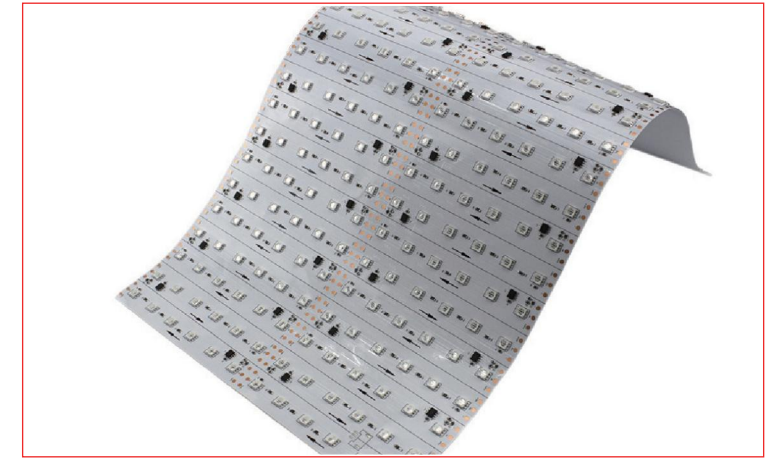

SPI TM923IC IP54 24V 480\*240 mm 1 PCS Package

**Basic Parameters**

Power	75W/PCS
Input Voltage	24VDC
Input Current	3.147A/PCS
Cutting Unit	20*240mm
Size	480*240*1.84mm
Bend Diameter	>60mm
Copper foil	2oz

**Luminous Intensity Distribution**

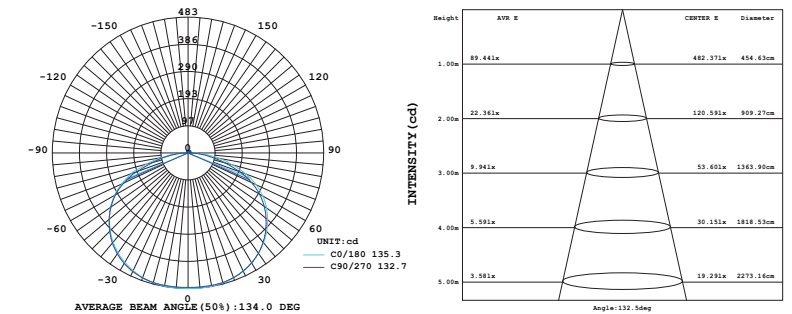

**Photo-electric Parameters**

COLOR	LM/M	LM/W
RGB <span style="color:red">■</span> <span style="color:green">■</span> <span style="color:blue">■</span>	1751	23

**Recommended Accessories**

Image			
Code	4PIN-20AWG	V3+R8-1	LRS-100-24



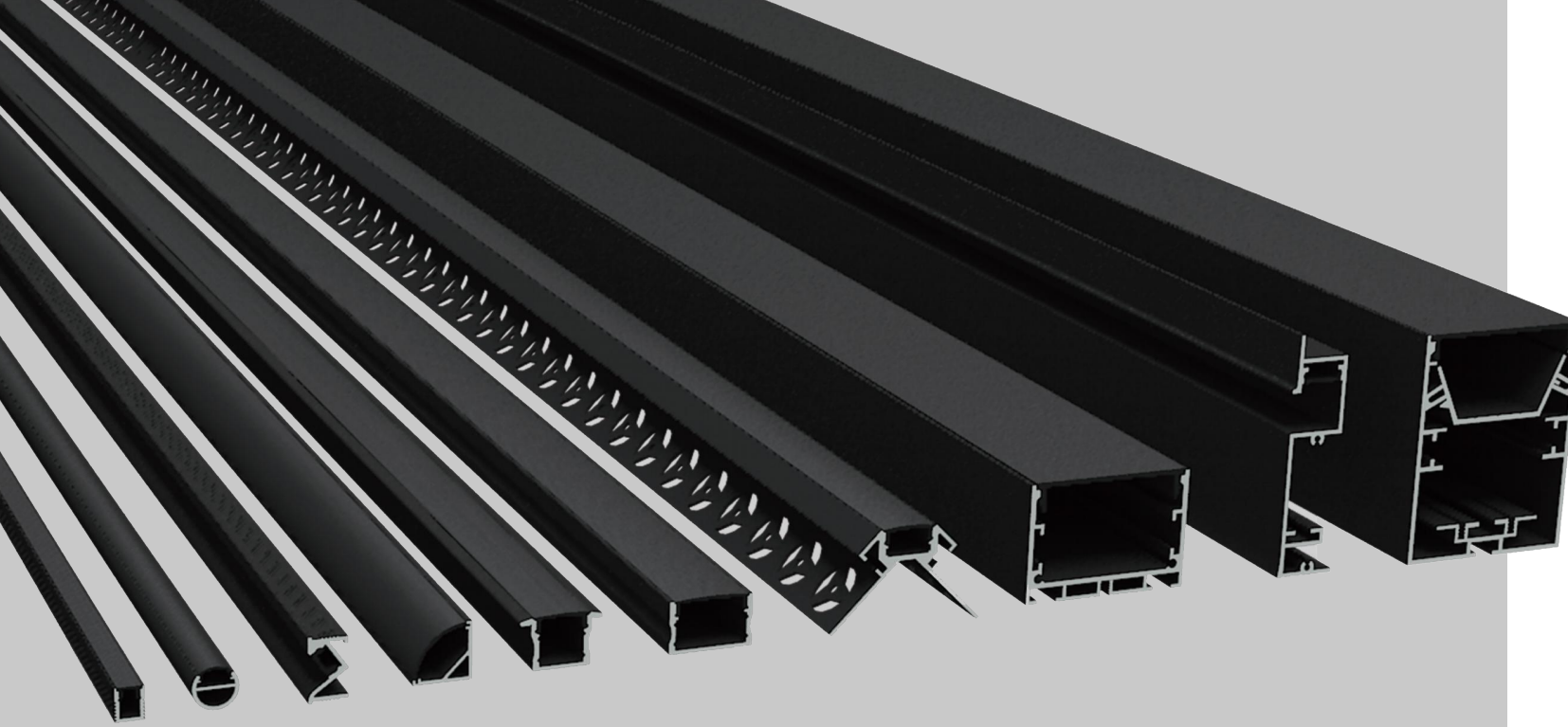

## Best choice for linear lighting Khun Aluminum Profile

Al6063-T5 aluminum profile with high quality surface treatment and excellent heat dissipation performance.  
Easy to install and maintain the light source.  
It can be widely used in ceiling, wall, ground and other scenes to create fashionable and novel space decoration lighting effect.



## Hot-sale Series

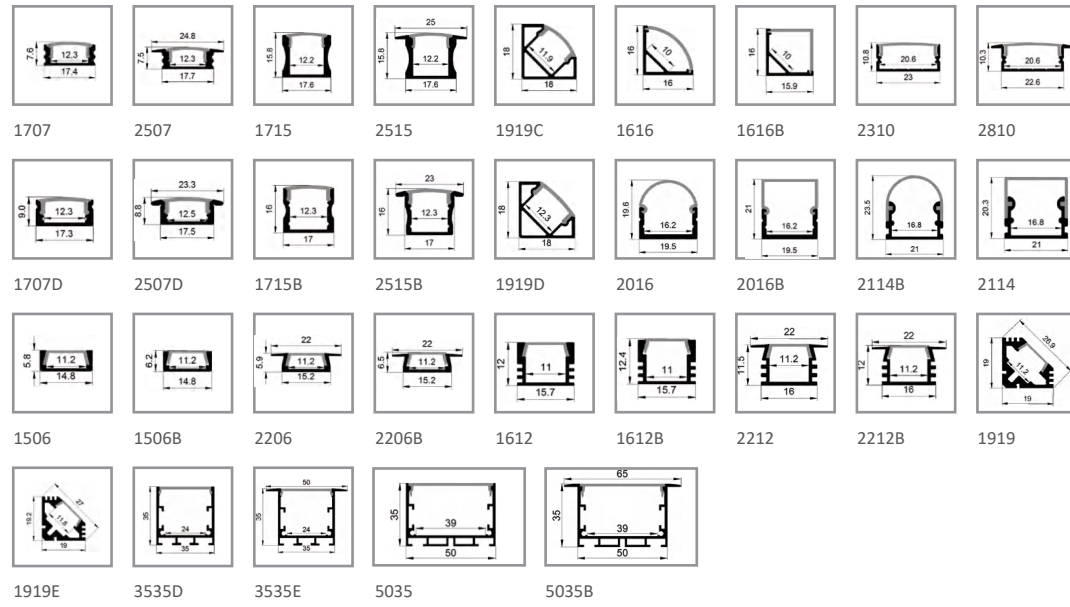

## Surface Mounted Series

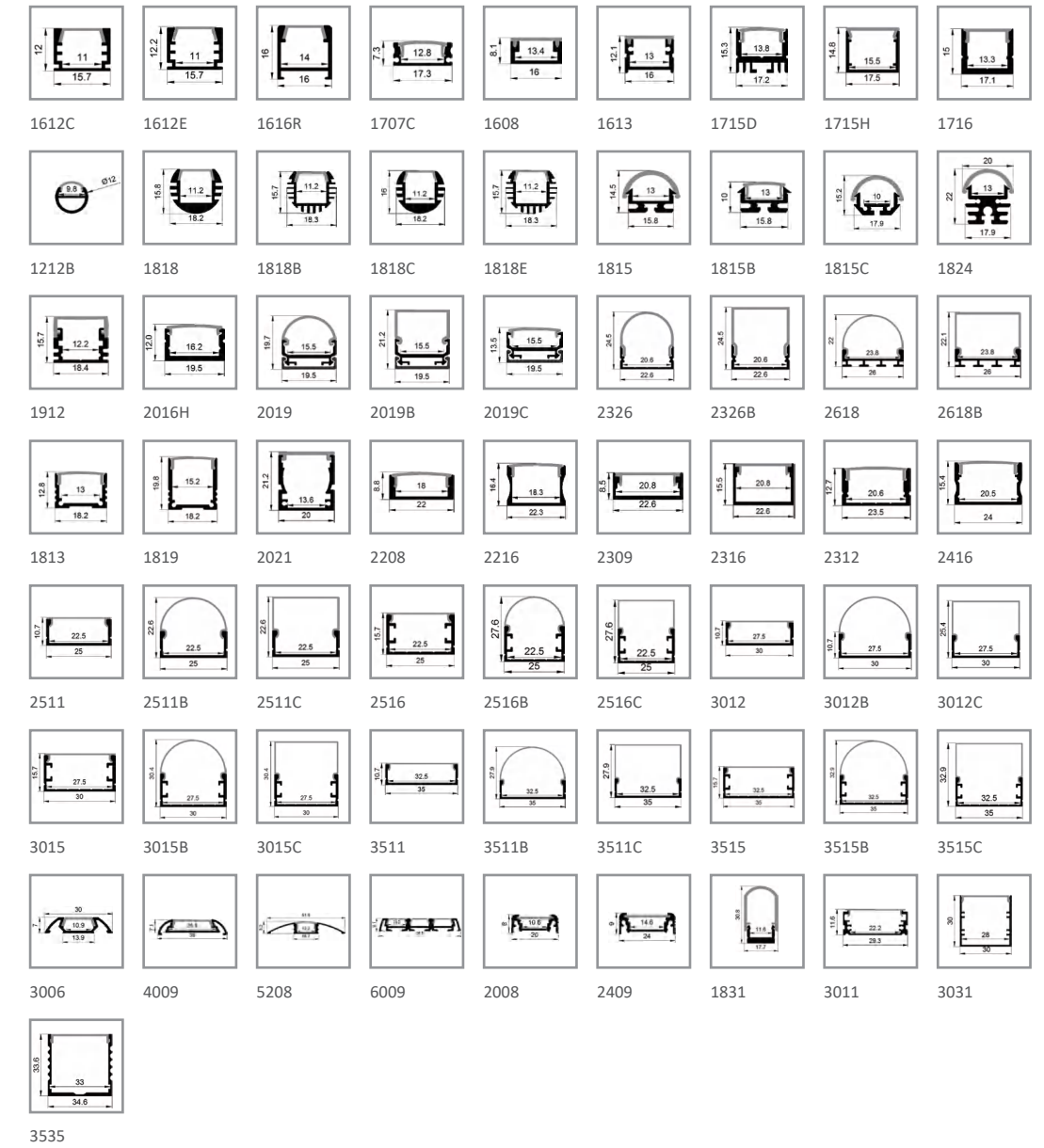

## Mini Series

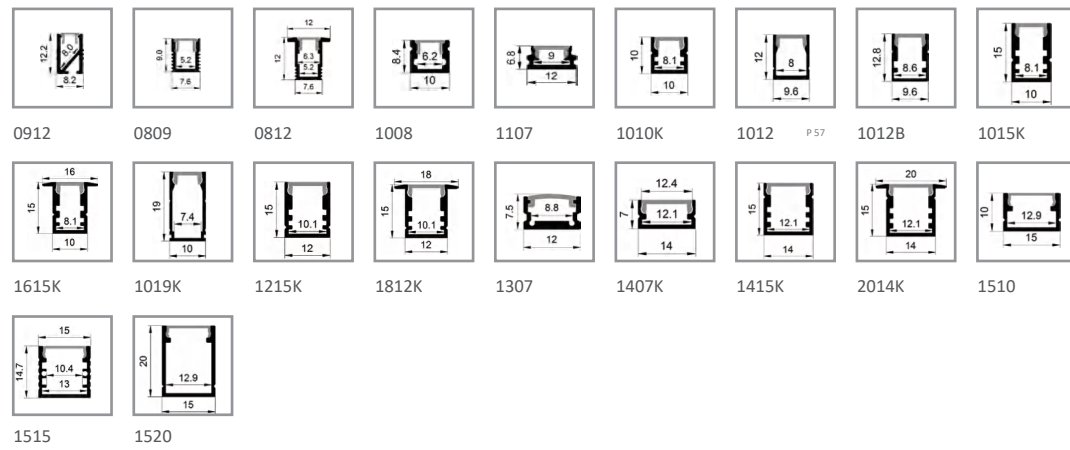

## Angular Series

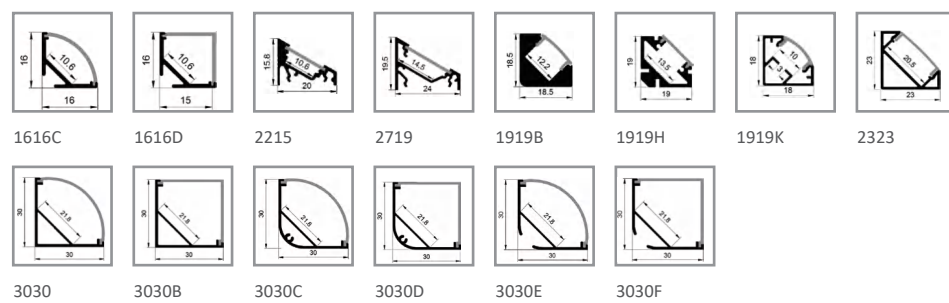

## Lens Beam Angle

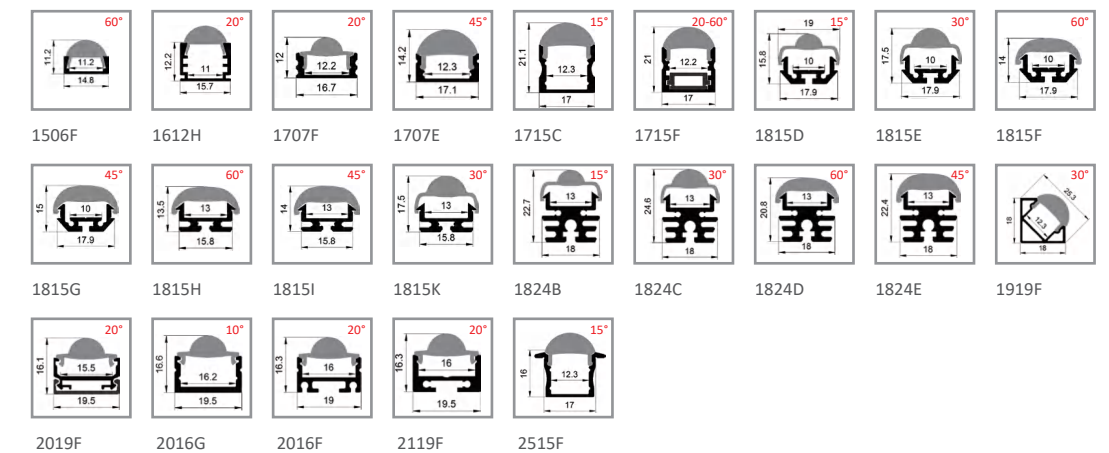



## Wall Series

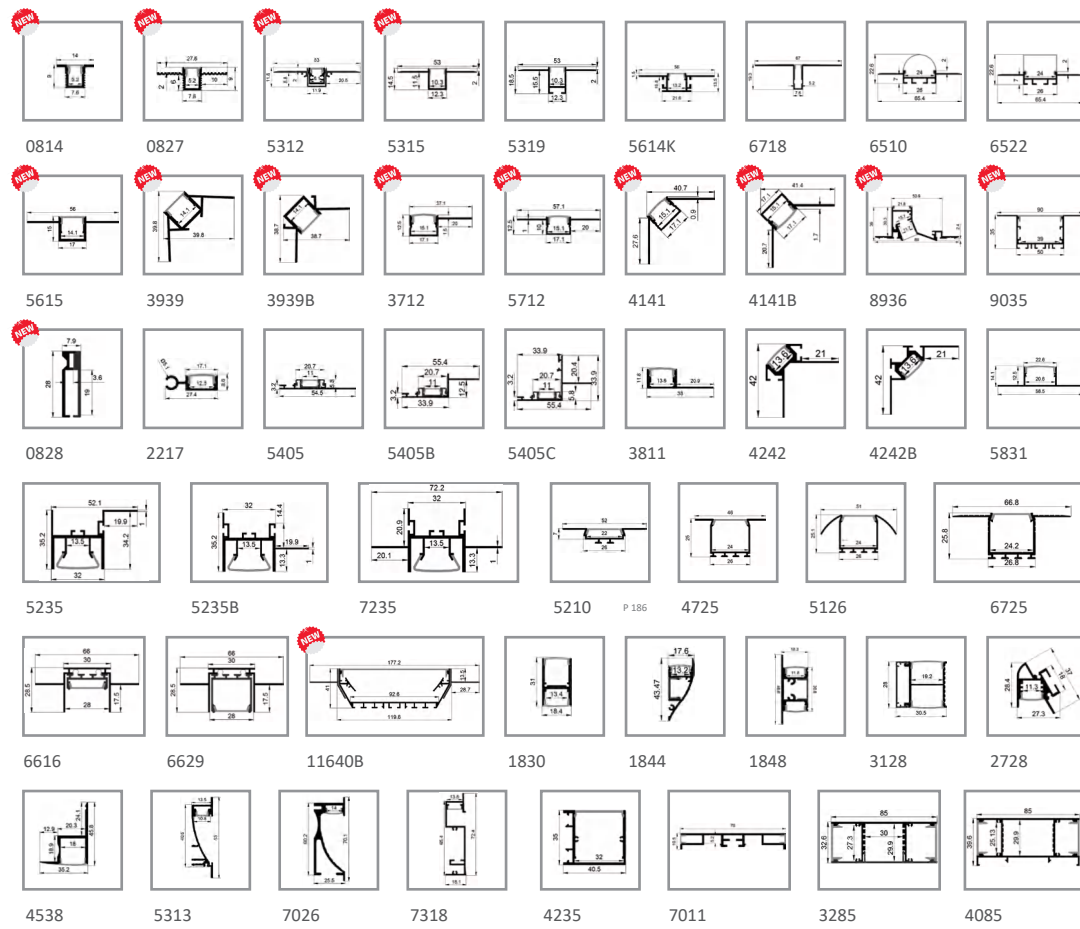

## Recessed Series

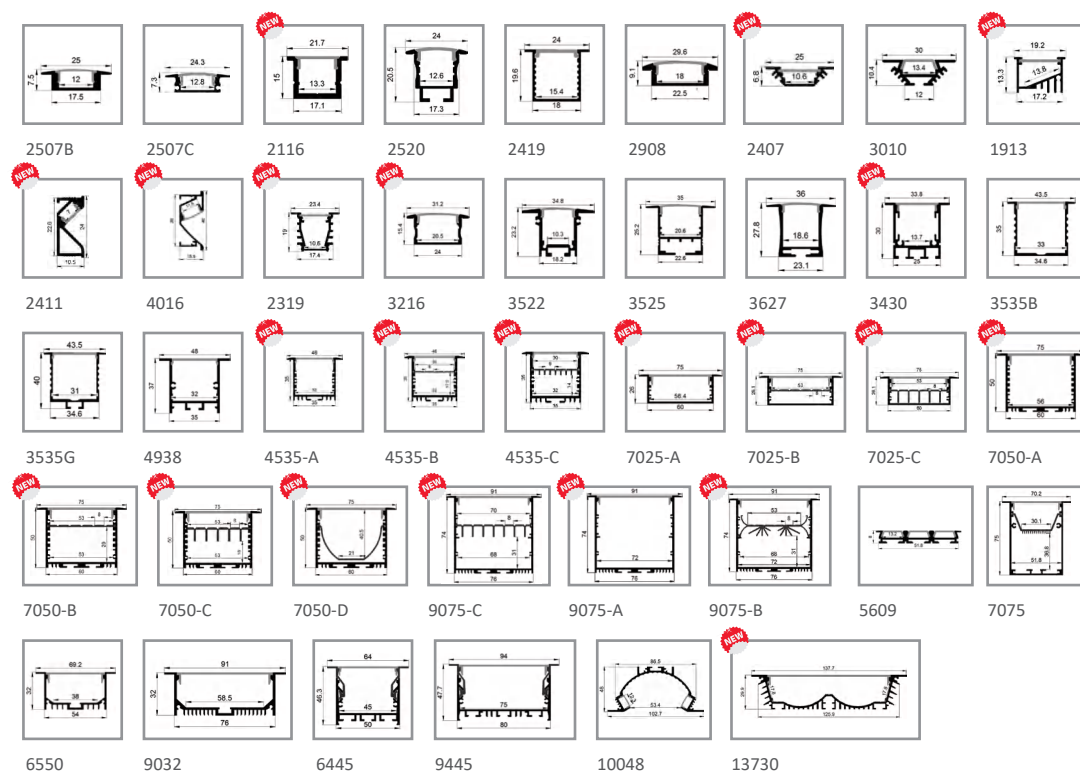

## Suspending and Surface Series

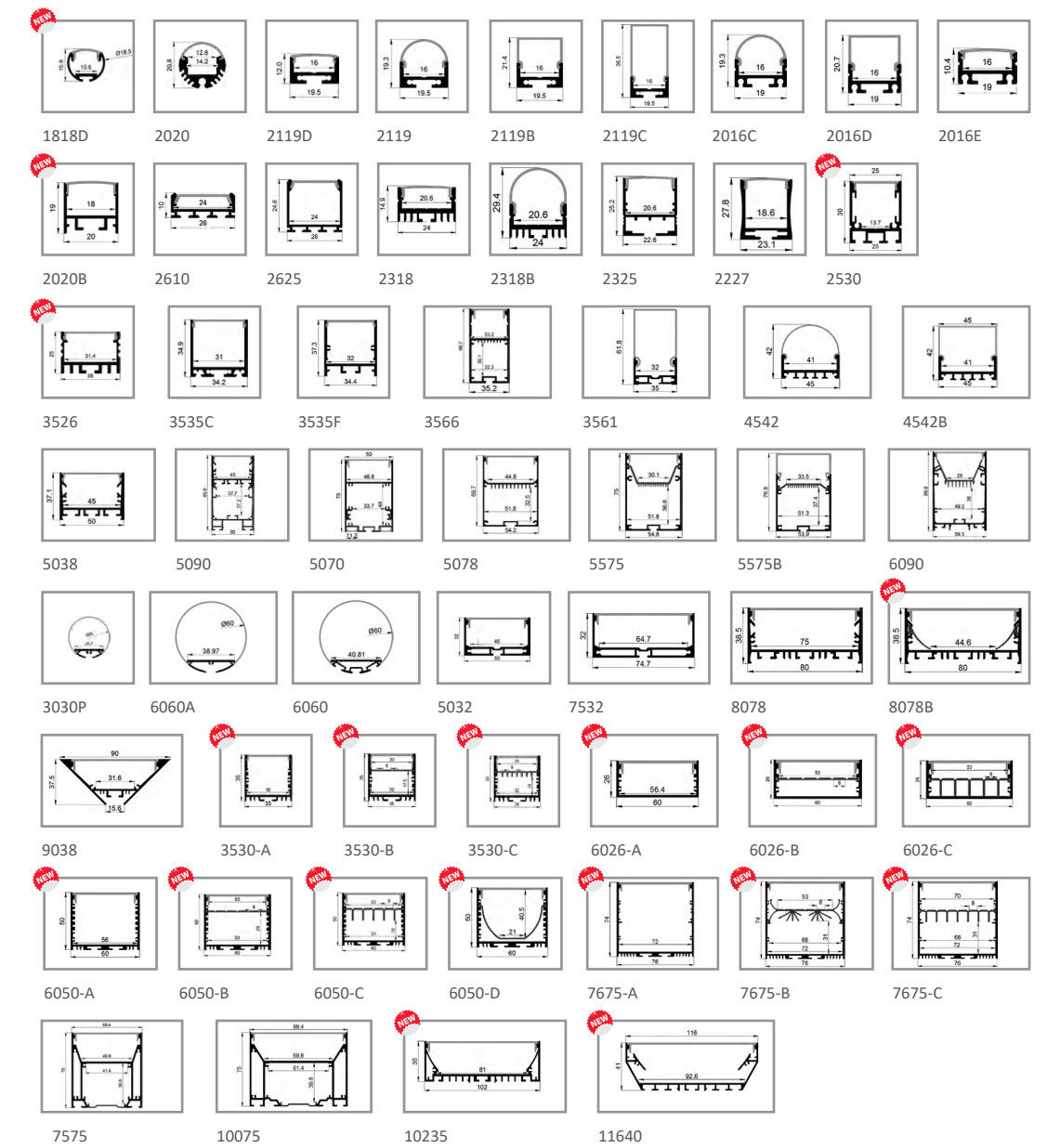

## Floor Series

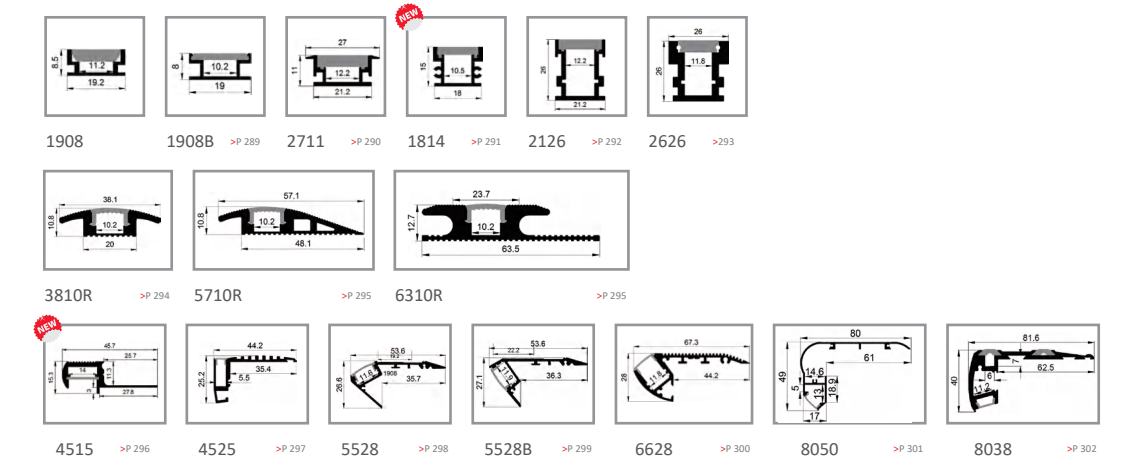

Special Series

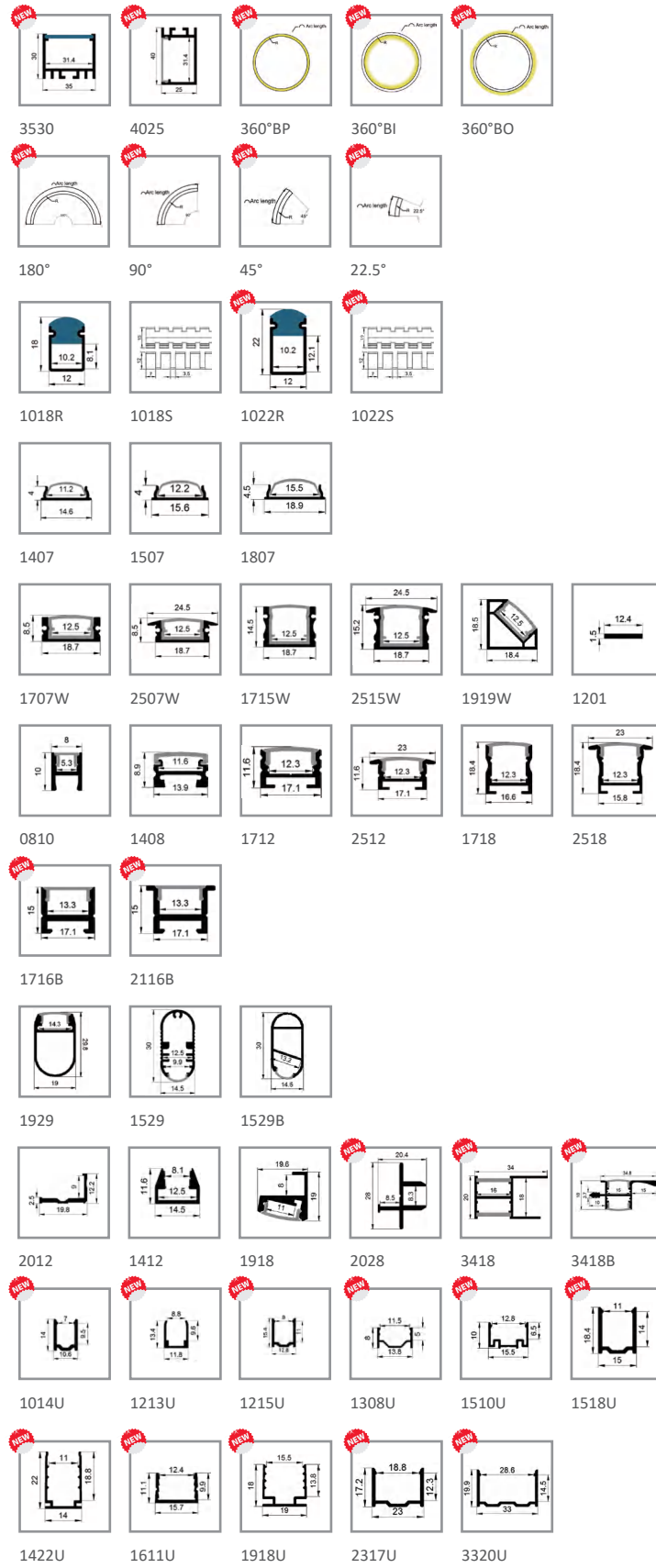





## HOT-SALE SERIES

LL1616B

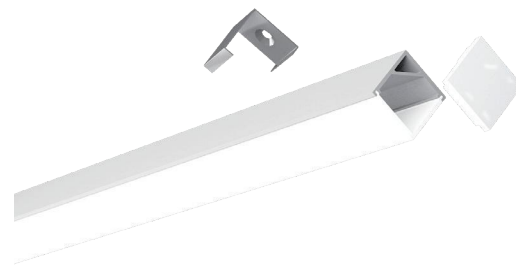
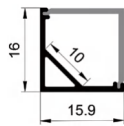

### ALU PROFILE

LL1616B 6063-T5 1M,2M,3M



### COVER

LL1616B PC 1M,2M,3M Push in



### ACCESSORIES

End Cap

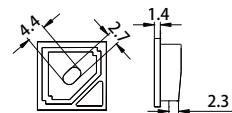

Clip

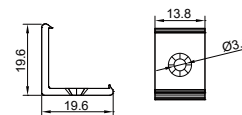
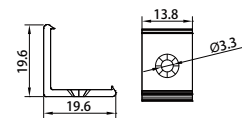

## HOT-SALE SERIES

LL1707D

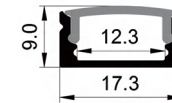

### ALU PROFILE

LL1707D 6063-T5 1M,2M,3M



### COVER

LL1707D PC 1M,2M,3M Push in



### ACCESSORIES

End Cap

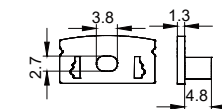

Clip

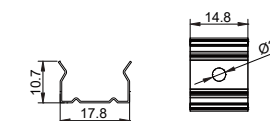

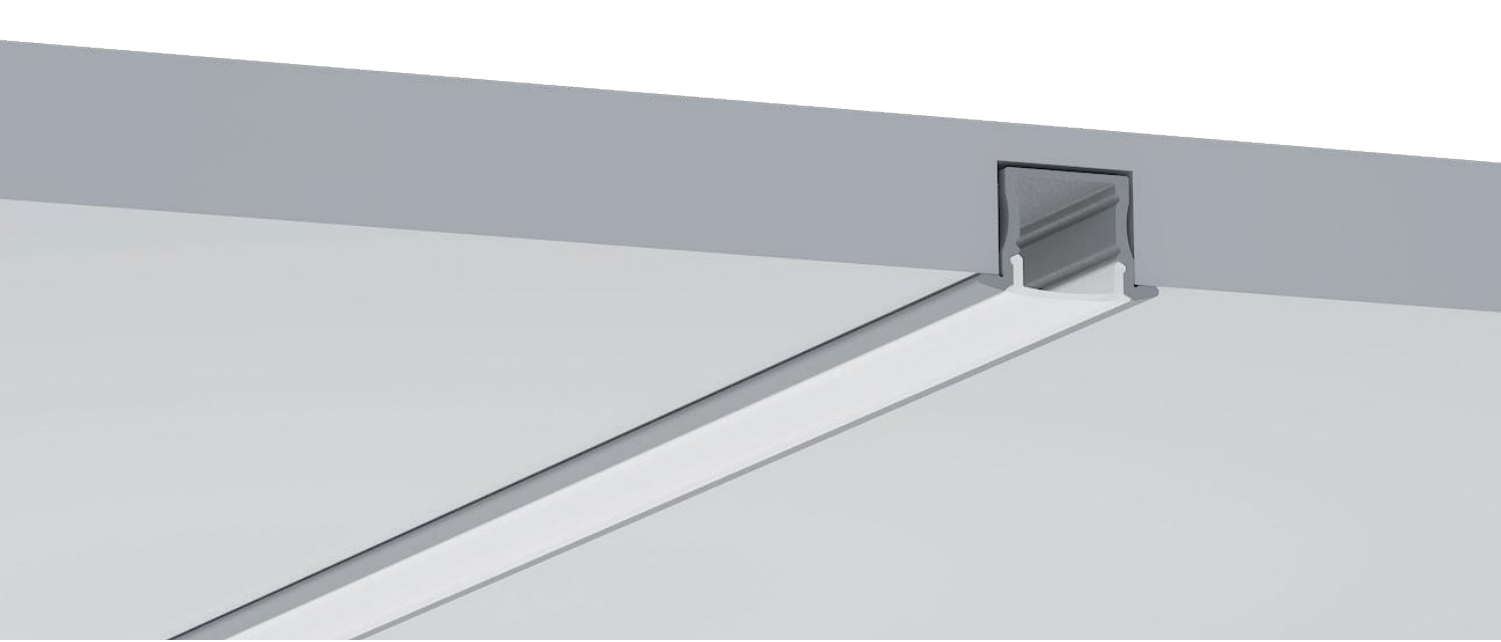

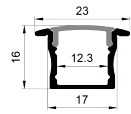

### LL2515B



### ALU PROFILE

LL2515B	6063-T5	1M,2M,3M			
			Silver	Black	

### COVER

LL2515B	PC	1M,2M,3M	Push in			
				Opal	Diffuser	Clear

### ACCESSORIES



End Cap				
		White	Black	Silver

Clip		
		Stainless steel

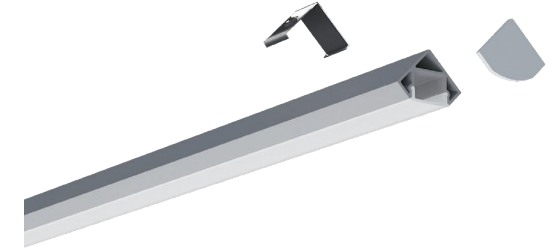
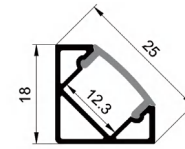
### LL1919D

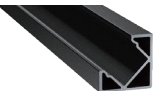

### ALU PROFILE



LL1919D	6063-T5	1M,2M,3M			
			Silver	Black	

### COVER

LL1919D	PC	1M,2M,3M	Push in			
				Opal	Diffuser	Clear

### ACCESSORIES

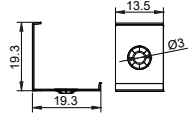
End Cap				
		White	Black	Silver

Clip		
		Stainless steel



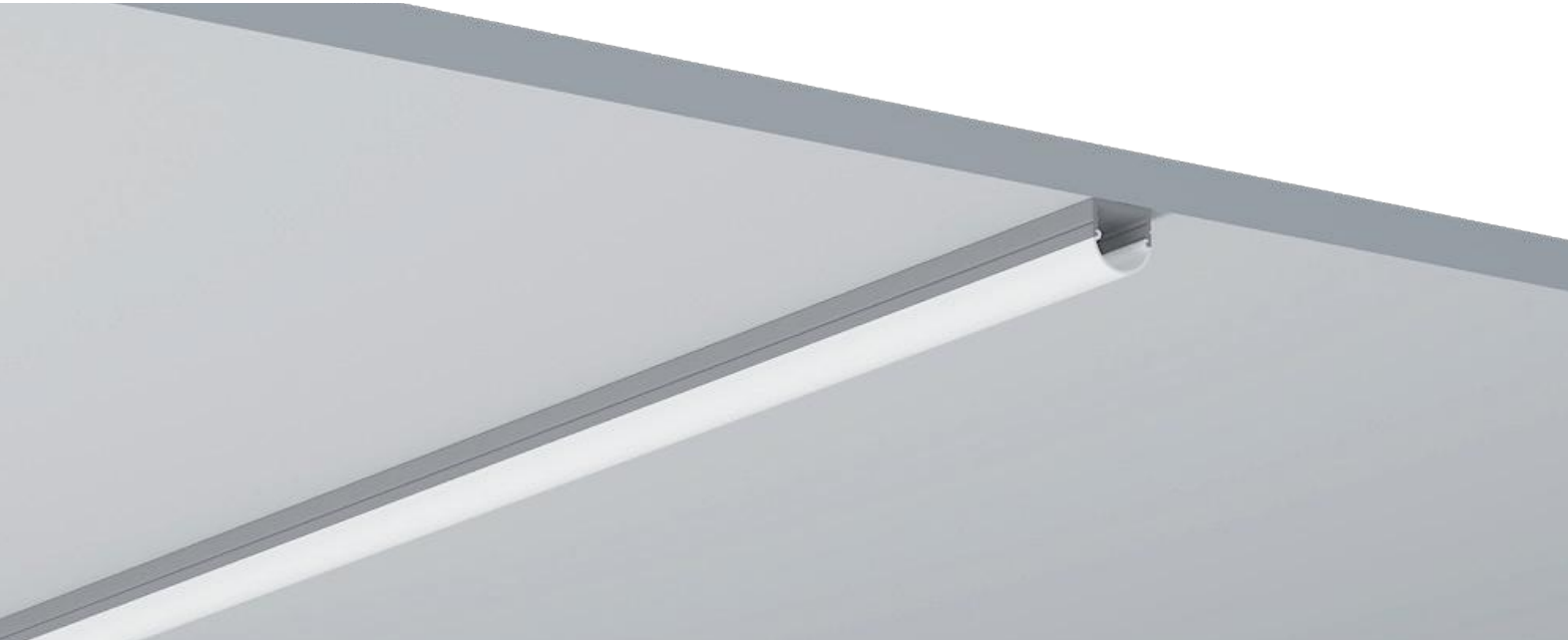

## HOT-SALE SERIES

LL2016

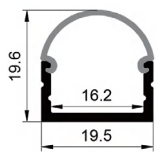

### ALU PROFILE

LL2016 6063-T5 1M,2M,3M



### COVER

LL2016 PC 1M,2M,3M Push in



### ACCESSORIES

End Cap

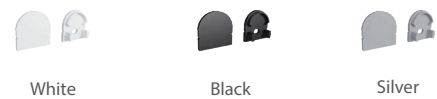
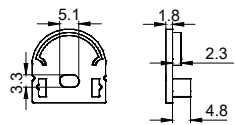

Clip

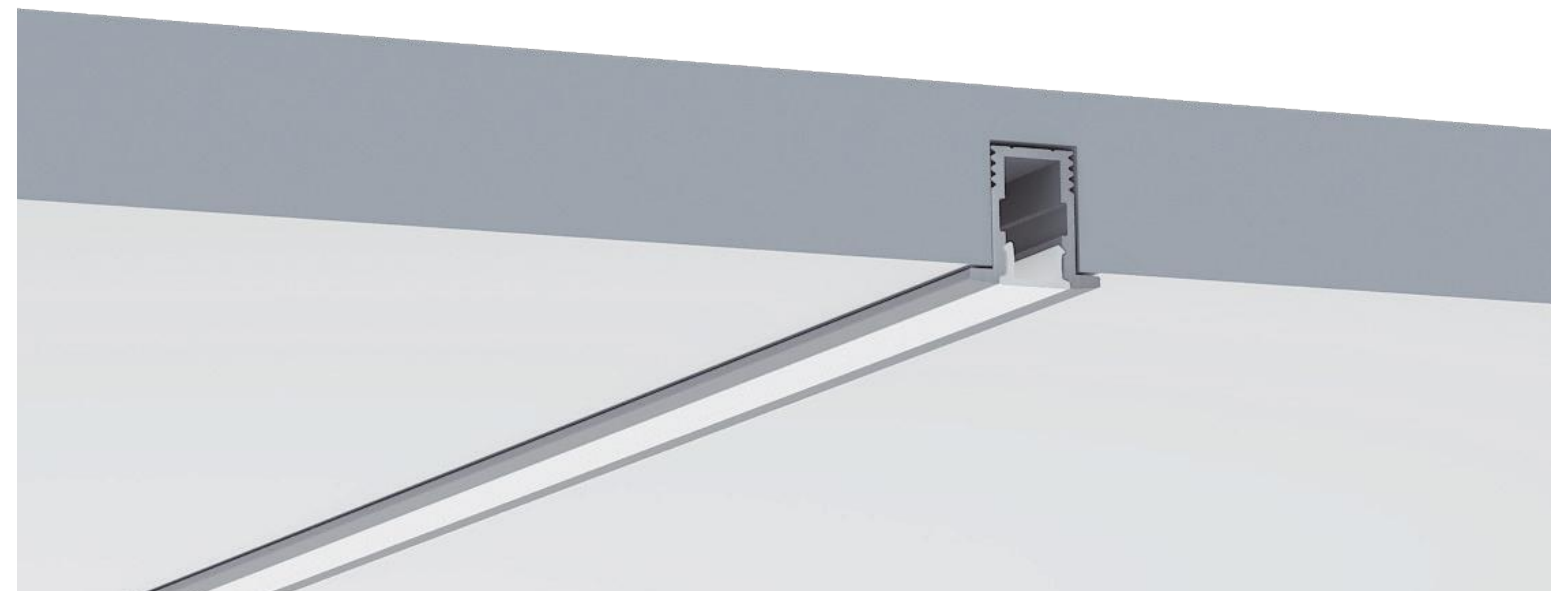
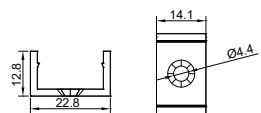

## MINI SERIES

LL0812

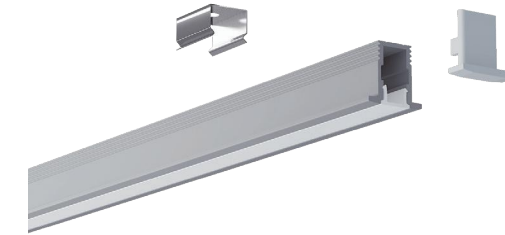
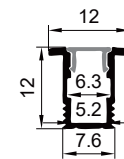

### ALU PROFILE

LL0812 6063-T5 1M,2M,3M



### COVER

LL0812PC PC 1M,2M,3M Push in



### ACCESSORIES

End Cap

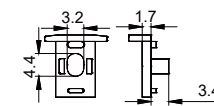

Clip

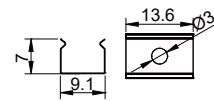

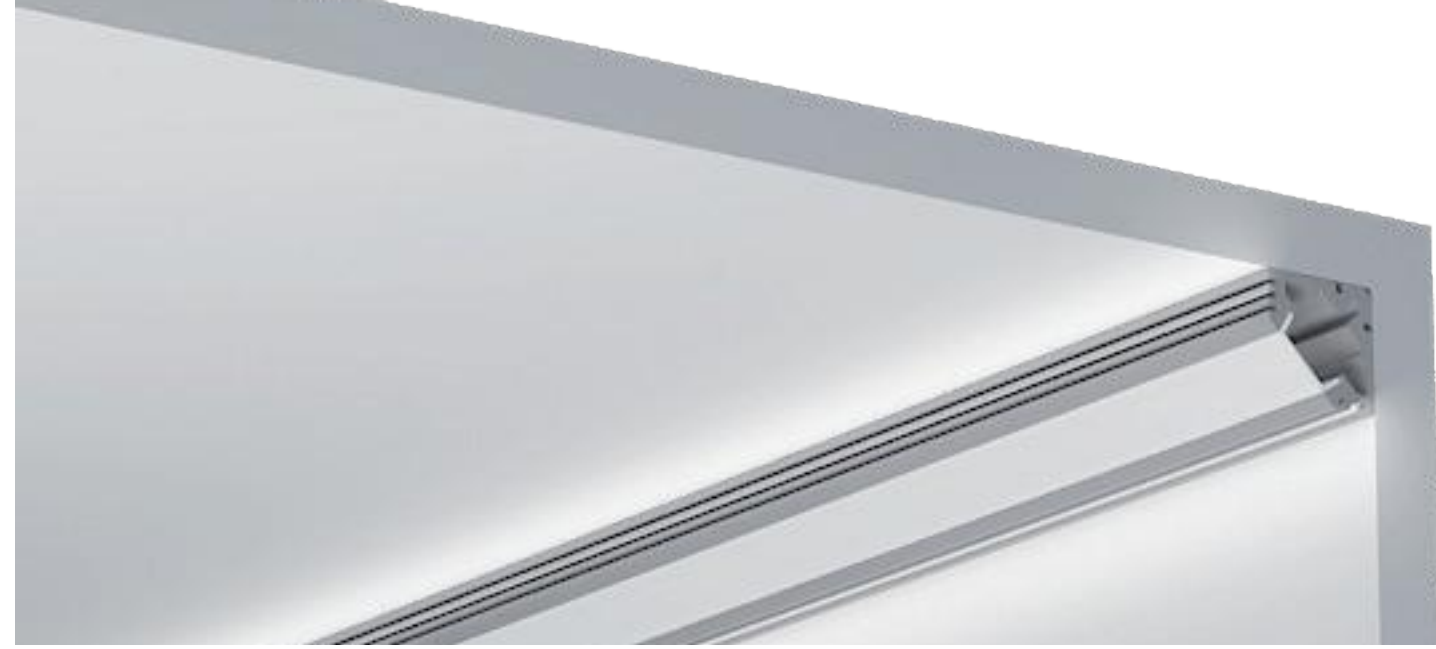
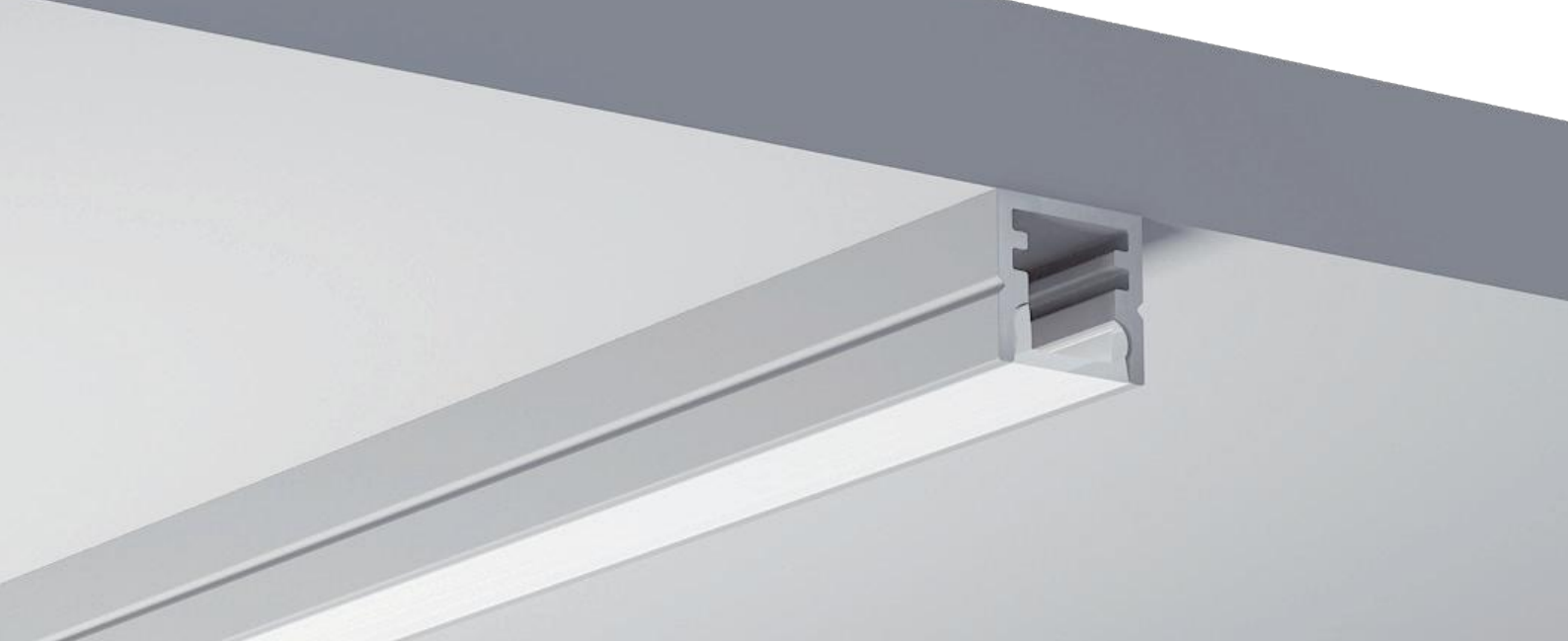

## MINI SERIES

### LL1010K

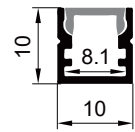

### ALU PROFILE

LL1010K 6063-T5 1M,2M,3M



### COVER

LL1010K PC 1M,2M,3M Push in



### ACCESSORIES

End Cap

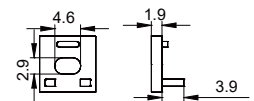

Clip

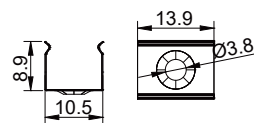

Stainless steel

## MINI SERIES

### LL1919

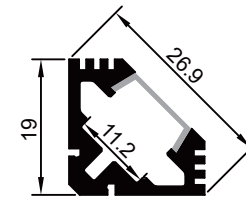

### ALU PROFILE

LL1919 6063-T5 1M,2M,3M



### COVER

LL1919 PC 1M,2M,3M Push in

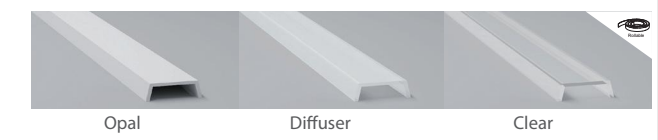

### ACCESSORIES

End Cap

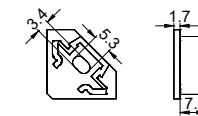

Clip

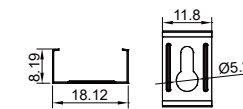

Stainless steel



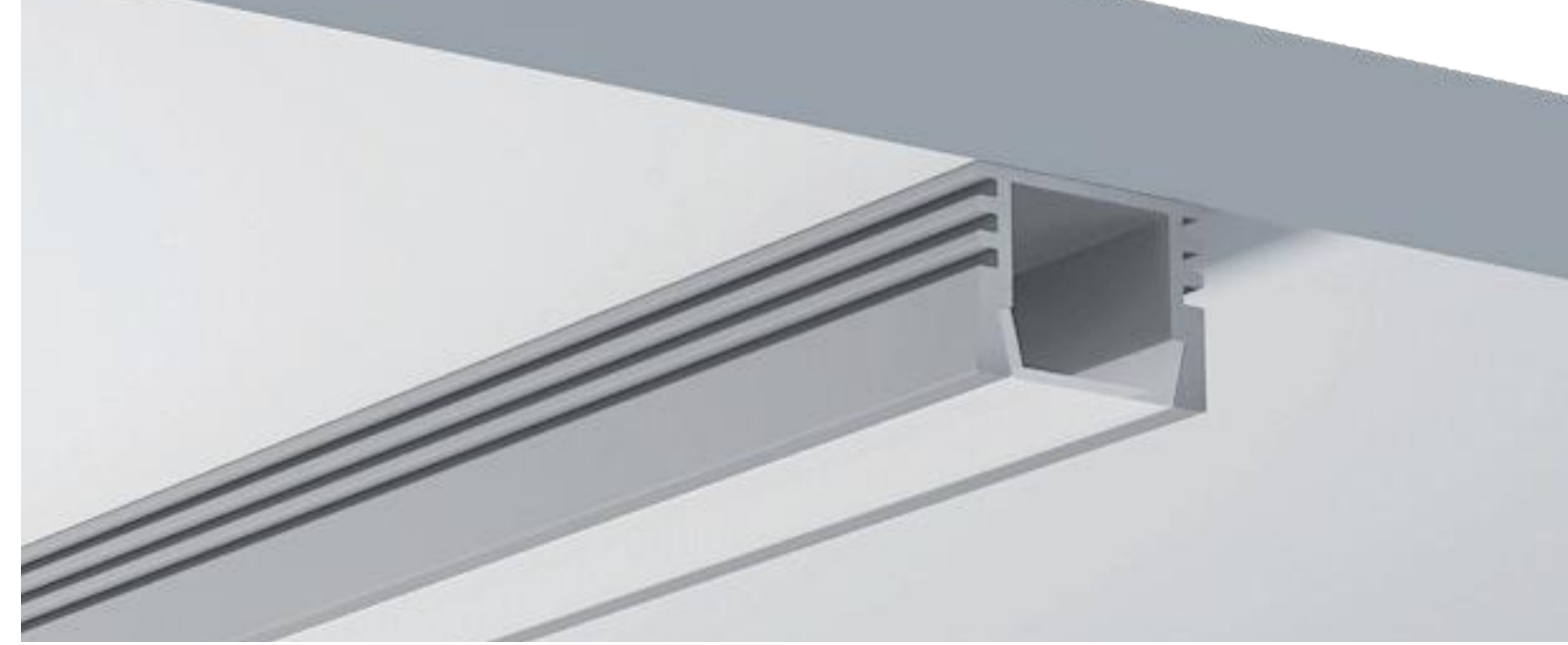
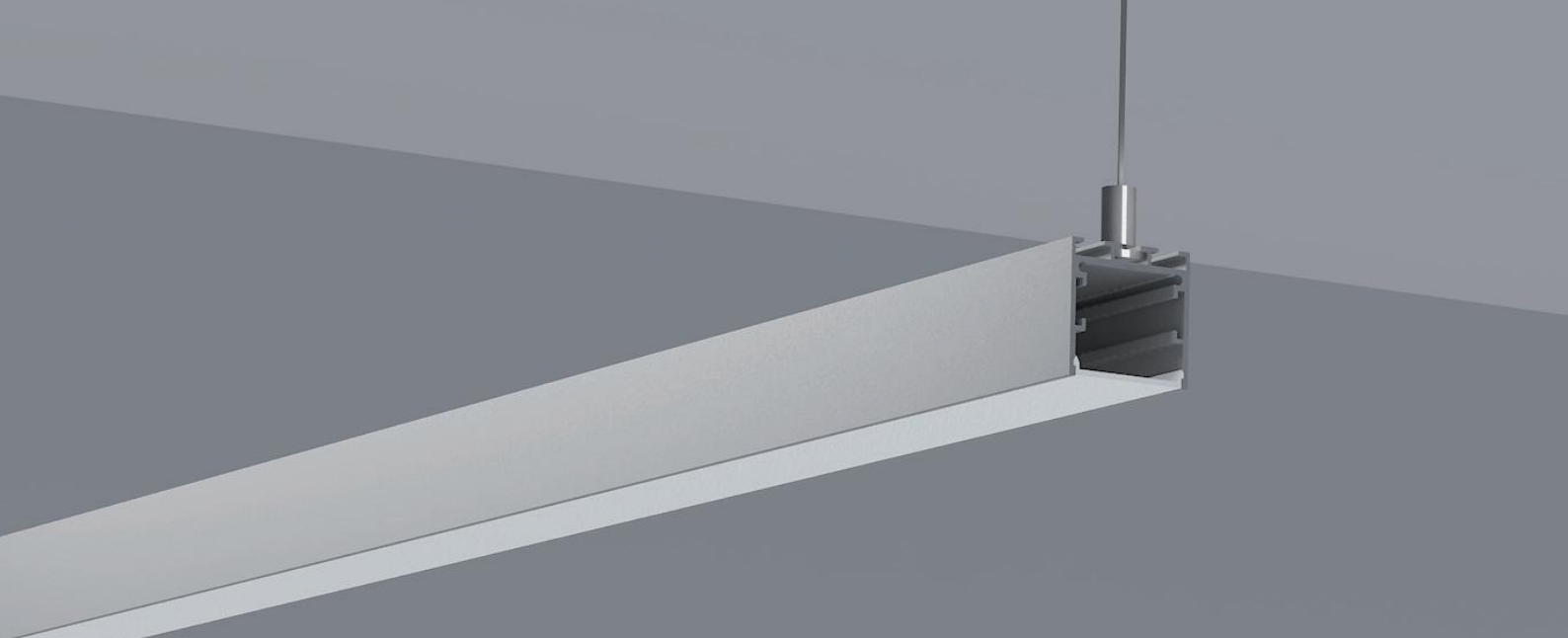

## HOT-SALE SERIES

### LL3535D

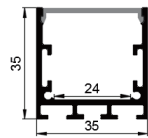

### ALU PROFILE

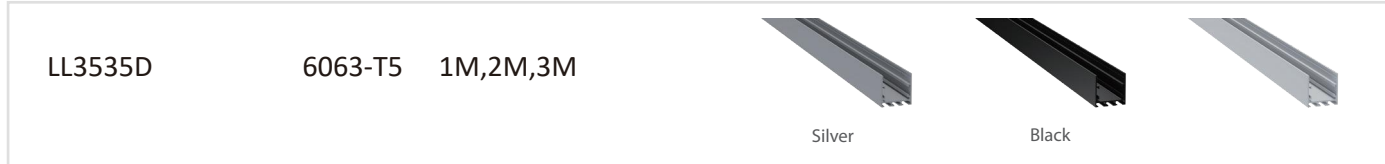

### COVER



### ACCESSORIES

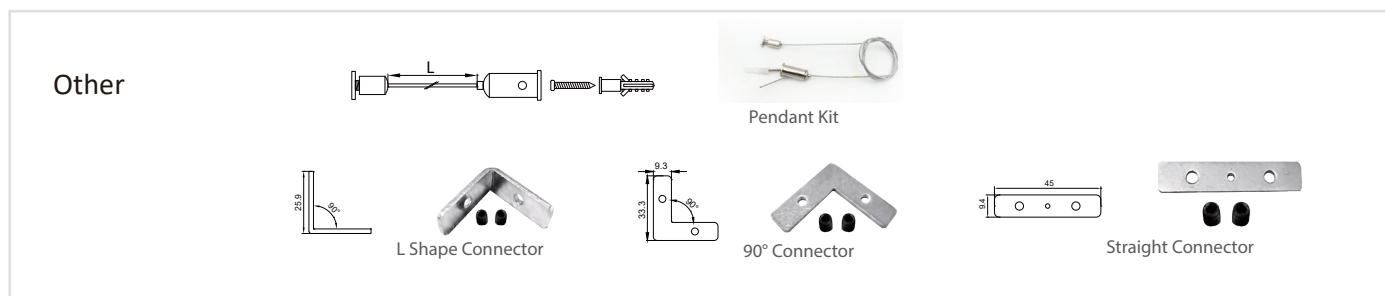

## MINI SERIES

### LL1612

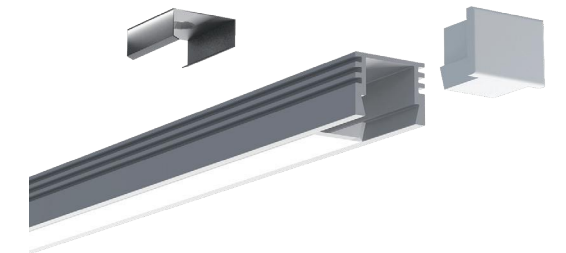
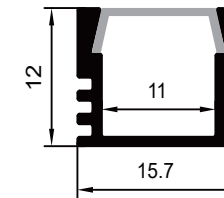

### ALU PROFILE



### COVER

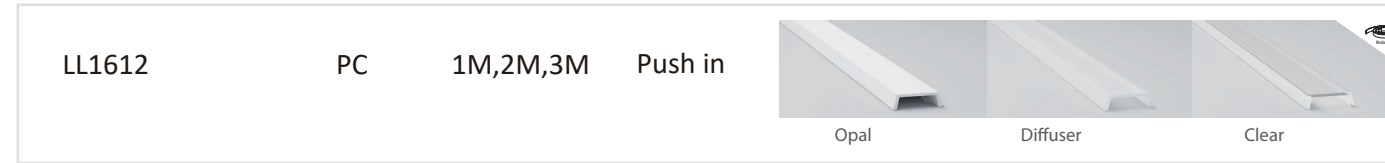

### ACCESSORIES



## One-Stop Shop Accessories for LED Strip Light



- Controller
- LED Driver
- End Cap
- Clip
- Connector

Complete accessories, professional service, save you time and money.



# Khun Controller →

## V1+R6-1

### Controller

Input voltage: 5-36V;  
 Output voltage: 5-36V  
 Output current: 1CH ≤ 8A, Max 8A  
 Output wattage: 5V< 40W; 12V<96W; 24V< 192W; 36V<288W;  
 Demension: 97\*33\*18mm  
 N.W: 38g  
 Certification: CE, EMC, LVD, RED  
 Warranty: 5 years

### Remote

Signal: 2.4G Hz wifi  
 Control distance: 30m, 1 zone;  
 Power: 3VDC (CR2032 battery)  
 Demension: 107\*58.5\*9mm  
 N.W.: 34.7g  
 Certification: CE, EMC, LVD, RED  
 Warranty: 5 years

Suitable for single color led strip light



## V2+R7-1

### Controller

Input voltage: 12-24V;  
 Output voltage: 12-24V  
 Output current: 1CH ≤ 5A, Max 10A  
 Output wattage: 12V<120W; 24V< 240W;  
 Demension: 97\*33\*18mm  
 N.W: 38g  
 Certification: CE, EMC, LVD, RED  
 Warranty: 5 years

### Remote

Signal: 2.4G Hz wifi  
 Control distance: 30m, 1 zone;  
 Power: 3VDC (CR2032 battery)  
 Demension: 107\*58.5\*9mm  
 N.W.: 34.7g  
 Certification: CE, EMC, LVD, RED  
 Warranty: 5 years

Suitable for dual CCT led strip light



## V3+R8-1

### Controller

Input voltage: 12-24V;  
 Output type: PWM constant voltage  
 Output current: 3CH ≤ 4A, Max 12A  
 Output wattage: 12V<144W; 24V< 288W;  
 Demension: 97\*33\*18mm  
 N.W: 38g  
 Certification: CE, EMC, LVD, RED  
 Warranty: 5 years

### Remote

Signal: 2.4G Hz wifi  
 Control distance: 30m, 1 zone;  
 Power: 3VDC (CR2032 battery)  
 Demension: 107\*58.5\*9mm  
 N.W.: 34.7g  
 Certification: CE, EMC, LVD, RED  
 Warranty: 5 years

Suitable for RGB led strip light



## RS-VP+R8-1

### Controller

Input voltage: 12-24V;  
 Output type: PWM constant voltage  
 Output current: 4CH ≤ 3A, Max 12A  
 Output wattage: 12V<144W; 24V< 288W;  
 Demension: 114\*38\*20mm  
 N.W: 53g  
 Certification: CE, EMC, LVD, RED  
 Warranty: 5 years

### Remote

Signal: 2.4G Hz wifi  
 Control distance: 30m, 1 zone;  
 Power: 3VDC (CR2032 battery)  
 Demension: 107\*58.5\*9mm  
 N.W.: 34.7g  
 Certification: CE, EMC, LVD, RED  
 Warranty: 5 years

Suitable for RGBW led strip light



## V4-X+RT4

### Controller

Input voltage: 12-48V;  
 Output type: PWM constant voltage  
 Output current: 4CH ≤ 8A@12V/24V; 4CH ≤ 5A @36V/48V  
 Output wattage: 384W@12V 768W@24V 720W@36V 960W@48V  
 Dimension: 117\*85\*24.5mm  
 N.W: 240g  
 Certification: CE, EMC, LVD, RED  
 Warranty: 5 years

### Remote

Signal: 2.4G Hz wifi  
 Control distance: 30m, 1 zone;  
 Power: 3VDC (CR2032 battery)  
 Dimension: 122\*53\*17.5mm  
 N.W.: 60g  
 Certification: CE, EMC, LVD, RED  
 Warranty: 5 years

Suitable for 12V/24V/48V  
 RGB & RGBW led Strip light



## V5-M+R1

### Controller

Input voltage: 12-24V;  
 Output voltage: 12-24V  
 Output current: 5CH ≤ 3A, Max 15A  
 Output wattage: 12V<180W; 24V< 360W;  
 Dimension: 221\*149\*45mm  
 N.W: 99g  
 Certification: CE, EMC, LVD, RED  
 Warranty: 5 years

### Remote

Signal: 2.4G Hz wifi  
 Control distance: 30m, 1 zone;  
 Power: 3VDC (CR2032 battery)  
 Dimension: 107\*58.5\*9mm  
 N.W.: 34.7g  
 Certification: CE, EMC, LVD, RED  
 Warranty: 5 years

Suitable for RGB+CCT led strip light



## S1-K

### AC Triac Rotary Panel Triac Dimmer

Input voltage: 100-240VAC;  
 Output voltage: 100-240VAC;  
 Output current: 1CH ≤ 1.2A;  
 Output type: PWM  
 Output wattage: 120W-288W;  
 Dimension: 86\*86\*50mm  
 N.W: 181g  
 Certification: CE, EMC, LVD  
 Warranty: 5 years

To dim and switch single color dimmable  
 LED strip light



## RS-EV4

### 4CH\*5A 12-36VDC CV Power Repeater

Input voltage: 12-36V;  
 Output voltage: 12-36V;  
 Output current: 4CH ≤ 5A;  
 Output type: PWM  
 Output wattage: 12V<240W, 24V<480W, 36V<720W  
 Dimension: 170\*50\*23mm  
 N.W: 120g  
 Certification: CE, EMC, LVD  
 Warranty: 5 years

Suitable for white/dual color/RGB  
 /RGBW led Strip





T13-K

Wall Mounted Rotary Panel  
(RGB DMX512 master)

Input voltage: 100-240VAC;  
Input current: Max 0.1A;  
Output signal: DMX 512, RF 2.4GHz;  
Dimming level: 256 levels;  
Dimming range: 0-100%;  
RF control distance: 10m without barriers  
Demension: 86\*86\*36.5mm  
N.W.: 181g  
Warranty: 5 years  
Certification: CE, EMC, LVD, RED

Suitable for DMX RGB led strip light



DS-L

DMX512-SPI Decoder and RF  
Controller

Input voltage: 5-24VDC;  
Power consumption: 1W;  
Input signal: DMX512+RF 2.4GHz;  
Output signal: SPI(TTL)x2;  
Control dots: 170pixels (RGB 510 CH)  
Max 900 pixels  
Dynamic modes: 32  
Demension: 170\*50\*23mm  
N.W.: 122g  
Warranty: 5 years  
Certification: CE,EMC, LVD

Suitable for Single or Dual SPI Signal  
Input RGB/RGBW LED Strip



SC

SPI RGB/RGBW LED RF Controller

Input voltage: 5-24V;  
Power consumption: 1W;  
Input signal: RF 2.4GHz;  
Output signal: SPI(TTL);  
Control dots: Max 1024 pixels;  
Dynamic modes: 32  
Demension: 97\*33\*18mm  
N.W.: 49g  
Warranty: 5 years  
certification: CE,EMC,LVD

Suitable for SPI RGB/RGBW LED Strip



RS-XC

SRF-DMX512 RGB/RGBW LED  
Controller

Input voltage:5-24V;  
Power consumption: 1W;  
Input signal: RF 2.4GHz;  
Output signal: DMX 512;  
Control dots: Max 170 RGB pixels;  
or 128RGBW pixels(512 channels)  
Dynamic modes: 32  
Demension:97\*33\*18mm  
N.W.: 38g  
Warranty: 5 years

Suitable for DMX  
RGB/RGBW LED Strip



# Power Supply →

1



LRS-35-12  
LRS-35-24  
LRS-35-48

35W nonwaterproof MeanWell Power Supply  
Input voltage: 85~264VAC  
Output voltage: 12/24/48VDC  
IP20/Size: 99\*82\*30mm (L\*W\*H)  
Non-dimming  
CE, UL certified/3 years warranty

2



LRS-50-12  
LRS-50-24  
LRS-50-48

50W nonwaterproof MeanWell LED Driver  
Input voltage: 85~264VAC  
Output voltage: 12/24/48VDC  
IP20/Size: 99\*82\*30mm (L\*W\*H)  
Non-dimming  
CE, UL certified/3 years warranty

3



LRS-75-12  
LRS-75-24  
LRS-75-48

75W nonwaterproof MeanWell LED Driver  
Input voltage: 85~264VAC  
Output voltage: 12/24/48VDC  
IP20/Size: 99\*97\*30mm (L\*W\*H)  
Non-dimming  
CE, UL certified/3 years warranty

4



LRS-100-12  
LRS-100-24  
LRS-100-48

100W nonwaterproof MeanWell LED Driver  
Input voltage: 85~264VAC  
Output voltage: 12/24/48VDC  
IP20/Size: 129\*97\*30mm (L\*W\*H)  
Non-dimming  
CE, UL certified/3 years warranty

5



LRS-150-12  
LRS-150-24  
LRS-150-48

150W nonwaterproof MeanWell LED Driver  
Input voltage: 85~132VAC/170~264VAC by switch  
Output voltage: 12/24/48VDC  
IP20/Size: 159\*97\*30mm (L\*W\*H)  
Non-dimming  
CE, UL certified/3 years warranty

6



LRS-200-12  
LRS-200-24  
LRS-200-48

200W nonwaterproof MeanWell LED Driver  
Input voltage: 90~132VAC/180~264VAC by switch  
Output voltage: 12/24/48VDC  
IP20/Size: 215\*115\*30mm (L\*W\*H)  
Non-dimming  
CE, UL certified/3 years warranty

7



LRS-350-12  
LRS-350-24  
LRS-350-48

350W nonwaterproof MeanWell LED Driver  
Input voltage: 90~132VAC/180~264VAC by switch  
Output voltage: 12/24/48VDC  
IP20/Size: 215\*115\*30mm (L\*W\*H)  
Non-dimming  
CE, UL certified/3 years warranty

8



HLG-60H-24A  
HLG-60H-48A

60W Waterproof MeanWell LED Driver  
Input voltage: 90~305VAC  
Output voltage: 24/48VDC  
IP65/Size: 171\*61.5\*36.8mm (L\*W\*H)  
Non-dimming (Dimming optional)  
CE, UL certified/7 years warranty

9



HLG-100H-24A  
HLG-100H-48A

100W Waterproof MeanWell LED Driver  
Input voltage: 90~305VAC  
Output voltage: 24/48VDC  
IP65/Size: 220\*68\*38.8mm (L\*W\*H)  
Non-dimming (Dimming optional)  
CE, UL certified/7 years warranty

10



HLG-150H-12A  
HLG-150H-24A  
HLG-150H-48A

150W Waterproof MeanWell LED Driver  
Input voltage: 90~305VAC  
Output voltage: 12/24/48VDC  
IP65/Size: 228\*68\*38.8mm (L\*W\*H)  
Non-dimming (Dimming optional)  
CE, UL certified/7 years warranty



11



HLG-240H-12A  
HLG-240H-24A  
HLG-240H-48A

240W Waterproof MeanWell LED Driver  
Input voltage: 90~305VAC  
Output voltage: 12/24/48VDC  
IP65/Size: 244.2\*68\*38.8mm (L\*W\*H)  
Non-dimming (Dimming optional)  
CE, UL certified/7 years warranty

12



HLG-320H-12A  
HLG-320H-24A  
HLG-320H-48A

320W Waterproof MeanWell LED Driver  
Input voltage: 90~305VAC  
Output voltage: 12/24/48VDC  
IP65/Size: 252\*90\*43.8mm (L\*W\*H)  
Non-dimming (Dimming optional)  
CE, UL certified/7 years warranty

13



HLG-480H-24A  
HLG-480H-48A

480W Waterproof MeanWell LED Driver  
Input voltage: 90~305VAC  
Output voltage: 24/48VDC  
IP65/Size: 262\*125\*43.8mm (L\*W\*H)  
Non-dimming (Dimming optional)  
CE, UL certified/7 years warranty

14



HLG-600H-24A  
HLG-600H-48A

600W Waterproof MeanWell LED Driver  
Input voltage: 90~305VAC  
Output voltage: 24/48VDC  
IP65/Size: 280\*144\*48.5mm (L\*W\*H)  
Non-dimming (Dimming optional)  
CE, UL certified/7 years warranty

15



US-30-12 LI1  
US-30-24 LI1

30W Nonwaterproof Eaglerise LED Driver  
Input voltage: 220~240VAC  
Output voltage: 12/24VDC  
IP20/Size: 261\*30\*17mm (L\*W\*H)  
Non-dimming  
CE certified/5 years warranty

16



US-60-12 LI1  
US-60-24 LI1

60W Nonwaterproof Eaglerise LED Driver  
Input voltage: 220~240VAC  
Output voltage: 12/24VDC  
IP20/Size: 329\*30\*17mm (L\*W\*H)  
Non-dimming  
CE certified/5 years warranty

17



US-100-12 LI1  
US-100-24 LI1

100W Nonwaterproof Eaglerise LED Driver  
Input voltage: 220~240VAC  
Output voltage: 12/24VDC  
IP20/Size: 365\*30\*18mm (L\*W\*H)  
Non-dimming  
CE certified/5 years warranty

18



US-160-24 LI1

160W Nonwaterproof Eaglerise LED Driver  
Input voltage: 220~240VAC  
Output voltage: 12/24VDC  
IP20/Size: 395\*30.5\*21.5mm (L\*W\*H)  
Non-dimming  
CE certified/5 years warranty

19



LS-45-24  
DALI2 LI

45W DALI Dimming Eaglerise LED Driver  
Input voltage: 220~240VAC  
Output voltage: 24VDC  
IP20/Size: 187\*45\*30.5mm (L\*W\*H)  
Dimming  
CE certified/5 years warranty

20



LS-80-24  
DALI2 LI

80W DALI Dimming Eaglerise LED Driver  
Input voltage: 220~240VAC  
Output voltage: 24VDC  
IP20/Size: 290\*43\*30.5mm (L\*W\*H)  
Dimming  
CE certified/5 years warranty

21



LS-150-24 DALI2 LI

150W DALI Dimming Eaglerise LED Driver  
Input voltage: 220~240VAC  
Output voltage: 24VDC  
IP20/Size: 290\*43\*30.5mm (L\*W\*H)  
Dimming  
CE certified/5 years warranty

22



FLS-20-700 0-10 LA

20W 0-10V Dimming Eaglerise LED Driver  
Input voltage: 220~240VAC  
Output voltage: 12-40VDC  
IP20/Size: 125\*45\*27.5mm (L\*W\*H)  
Dimming  
CE certified/5 years warranty

23



FLS-40-1050 0-10 LA

40W 0-10V Dimming Eaglerise LED Driver  
Input voltage: 220~240VAC  
Output voltage: 12-45VDC  
IP20/Size: 170\*45\*30mm (L\*W\*H)  
Dimming  
CE certified/5 years warranty

End cap & Clip



1



EC-W0801

silicone end cap without hole,  
suitable for 8mm FPC,  
IP67/IP68 waterproof led strip light

2



EC-W0802

silicone end cap with hole,  
suitable for 8mm FPC,  
IP67/IP68 waterproof led strip light

3



EC-W1003

silicone end cap without hole,  
suitable for 10mm FPC,  
IP67/IP68 waterproof led strip light

4



EC-W1004

silicone end cap with hole,  
suitable for 10mm FPC,  
IP67/IP68 waterproof led strip light





5







EC-W1205

silicone end cap without hole,  
suitable for 12mm FPC,  
IP67/IP68 waterproof led strip light



<b>6</b>		EC-W1206	silicone end cap with hole, suitable for 12mm FPC, IP67/IP68 waterproof led strip light
<b>7</b>		EC-S0806	Silicone end cap set with hole and without hole, suitable for 8mm FPC, IP65 silicone extrusion led strip light
<b>8</b>		EC-S1008	Silicone end cap set with hole and without hole, suitable for 10mm FPC, IP65 silicone extrusion led strip light
<b>9</b>		EC-S1209	Silicone end cap set with hole and without hole, suitable for 12mm FPC, IP65 silicone extrusion led strip light
<b>10</b>		EC-S0810	Silicone end cap set with hole and without hole, suitable for 8mm FPC, IP67 & IP68 silicone extrusion led strip light

<b>11</b>		EC-S1011	Silicone end cap set with hole and without hole, suitable for 10mm FPC, IP67 & IP68 silicone extrusion led strip light
<b>12</b>		EC-S1212	Silicone end cap set with hole and without hole, suitable for 12mm FPC, IP67 & IP68 silicone extrusion led strip light
<b>13</b>		FC-W0801	Fixed clip, transparent, self-tapping screws 3*8mm, suitable for 8mm IP65 silicone coating led strip light
<b>14</b>		FC-W1002	Fixed clip, transparent, self-tapping screws 3*8mm, suitable for 10mm IP65 silicone coating led strip light
<b>15</b>		FC-W0803	Fixed clip, transparent, self-tapping screws 3*8mm, suitable for 8mm IP20 led strip light

16



FC-W1004

Fixed clip,  
transparent,  
self-tapping screws 3\*8mm,  
suitable for 10mm IP20 led strip light

17



FC-W1205

Fixed clip,  
transparent,  
self-tapping screws 3\*8mm,  
suitable for 12mm IP20 led strip light

18

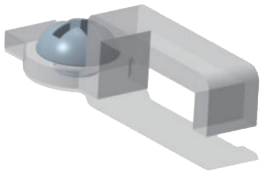

FC-W1006

Fixed clip,  
transparent,  
self-tapping screws 3\*8mm,  
suitable for 8mm IP67 silicone tube led strip light

19



FC-W1207

Fixed clip,  
transparent,  
self-tapping screws 3\*8mm,  
suitable for 12mm IP67 silicone tube led strip light

20

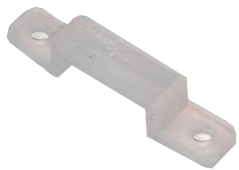

FC-W0808

Fixed clip,  
white,  
PA screws 3\*8mm,  
suitable for 8mm IP67 silicone tube led strip light

21



FC-W1009

Fixed clip,  
white,  
PA screws 3\*8mm,  
suitable for 10mm IP67 silicone tube led strip light

22



FC-W1210

Fixed clip,  
white,  
PA screws 3\*8mm,  
suitable for 12mm IP67 silicone tube led strip light



**Wire & Connector**



**1**



PIN-18AWG  
PIN-20AWG  
2PIN-22AWG

2PIN red and black wire,  
suitable for single color strip, L=150mm.  
18AWG, Outer diameter 1.0mm, loaded current 3A;  
20AWG, Outer diameter 0.8mm, loaded current 2A;  
22AWG, Outer diameter 0.6mm, loaded current 1.3A.

**2**



3PIN-18AWG  
3PIN-20AWG  
3PIN-22AWG

3PIN Yellow/White/Black wire, suitable for Dual color strip,  
L=150mm.  
18AWG, Outer diameter 1.0mm, loaded current 3A;  
20AWG, Outer diameter 0.8mm, loaded current 2A;  
22AWG, Outer diameter 0.6mm, loaded current 1.3A.

**3**



4PIN-18AWG  
4PIN-20AWG  
4PIN-22AWG

4PIN Blue/Red/Green/Black wire, suitable for RGB strip,  
L=150mm.  
18AWG, Outer diameter 1.0mm, loaded current 3A;  
20AWG, Outer diameter 0.8mm, loaded current 2A;  
22AWG, Outer diameter 0.6mm, loaded current 1.3A.

**4**



5PIN-20AWG

5PIN White/Blue/Red/Green/Black wire,  
suitable for RGBW strip, L=150mm.  
20AWG,  
Outer diameter 0.8mm,  
loaded current 2A.

**5**

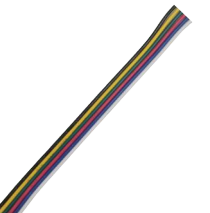

6PIN-20AWG

6PIN Yellow/White/Blue/Red/Green/Black wire,  
suitable for RGBWW strip, L=150mm.  
20AWG, Outer diameter 0.8mm,  
loaded current 2A.

**6**



2PIN-20AWG-W

2PIN white silicone cable (waterproof),  
suitable for Neon white color strip,  
L=200mm.  
20AWG,  
Outer diameter 0.8mm,  
loaded current 2A.

**7**



4PIN-20AWG-W

4PIN white silicone cable (waterproof),  
suitable for Neon RGB strip,  
L=200mm.  
20AWG,  
Outer diameter 0.8mm,  
loaded current 2A.

**8**



DC-NW1

DC Male&Female Connector (Non-Waterproof)  
Unilateral outlet,  
L=150mm

**9**



SM-NW1

SM Male&Female Connector (Non-Waterproof)  
Unilateral outlet, L=150mm

**10**



DC-W1

DC Male&Female Connector (Waterproof IP67)  
Unilateral outlet, L=150mm

11		SRW-8XB-2PIN SRW-10XB-2PIN SRW-10XB-3PIN SRW-10XB-4PIN SRW-10XB-5PIN SRW-12XB-6PIN	Classical SRW Connector Unilateral outlet, L=150mm 2PIN/3PIN/4PIN/5PIN/6PIN	16		SRW-8BB-2PIN SRW-10BB-2PIN SRW-10BB-3PIN SRW-10BB-4PIN SRW-10BB-5PIN SRW-12BB-6PIN	SRW Connector (Strip-to-Strip) 1. Working voltage: 12-24V 2. Working current: 0-3A 3. Suitable for IP20 led strip 4. Clamshell type. 5. Flame-retardant nylon + copper material. 2PIN/3PIN/4PIN/5PIN/6PIN
12		SRW-8BXB-2PIN SRW-10BXB-2PIN W-10BXB-3PIN SRW-10BXB-4PIN SRW-10BXB-5PIN SRW-12BXB-6PIN	SRW Connector (Strip-to-Strip with wire) 1. Working voltage: 12-24V 2. Working current: 0-3A 3. Suitable for IP20 led strip 4. Clamshell type. 5. Flame-retardant nylon + copper material. 2PIN/3PIN/4PIN/5PIN/6PIN	17		PJS-2PIN	Power Jack Socket Connector 5.5mmX2.1mm Power Jack Socket for LED strip 2PIN
13		L1-8BB-2PIN L1-10BB-2PIN L1-10BB-3PIN L1-10BB-4PIN L1-10BB-5PIN L1-12BB-5PIN L1-12BB-6PIN	L 1 type connector (Strip-to-Strip with FPC) Used for single color, CCT, RGB,RGBW, RGBWW led strip 2PIN/3PIN/4PIN/5PIN/6PIN	18		HM-N8XB-2PIN HM-N10XB-2PIN HM-N10XB-3PIN HM-N10XB-4PIN HM-N12XB-2PIN HM-N12XB-5PIN	Hippo-M (Strip-to-wire AWG#22-18 2Pin) 1. Working voltage: 0-36V 2. Working current: 6A 3. Suitable for tube led strip 4. Gland type. 5. Flame-retardant PC+copper material. 2PIN/3PIN/4PIN/5PIN
14		L2-8BXB-2PIN L2-10BXB-2PIN L2-10BXB-3PIN L2-10BXB-4PIN L2-10BXB-5PIN L2-12BXB-5PIN L2-12BXB-6PIN	L2 type connector (Strip-to-Strip with wire) Used for single color, CCT, RGB,RGBW, RGBWW led strip 2PIN/3PIN/4PIN/5PIN/6PIN	19		HM-N8BB-2PIN HM-N10BB-2PIN HM-N10BB-3PIN HM-N10BB-4PIN HM-N12BB-2PIN HM-N12BB-5PIN	Hippo-M (Strip-to-Strip) 1. Working voltage: 0-36V 2. Working current: 6A 3. Suitable for tube led strip 4. Gland type. 5. Flame-retardant PC+copper material. 2PIN/3PIN/4PIN/5PIN
15		L3-8BXB-2PIN L3-10BXB-2PIN L3-10BXB-3PIN L3-10BXB-4PIN L3-10BXB-5PIN L3-12BXB-5PIN L3-12BXB-6PIN	L3 Type Right Angle Connector (Strip-to-Strip with wire) Used for single color, CCT, RGB,RGBW, RGBWW led strip 2PIN/3PIN/4PIN/5PIN/6PIN	20		LPC-2PIN LPC-4PIN	LED Pin Connector (Strip-to-Strip with wire) Waterproof, suitable for single color, RGB led strip 2PIN/4PIN

**12 Years** Specialized in Architectural Lighting  
**KHUN** by nelux

Nelux (HK) International, Ltd.,  
18 harbour road, central plaza, Offices 3208, 32/F  
Wanchai, Hong Kong, China

 852-28600042

 852-28600066

 sales@nelux.com.hk